

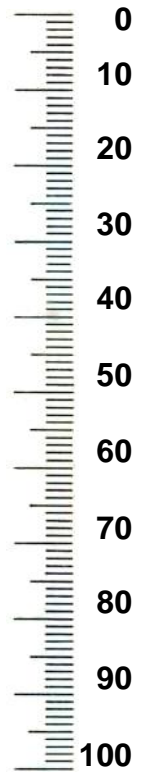

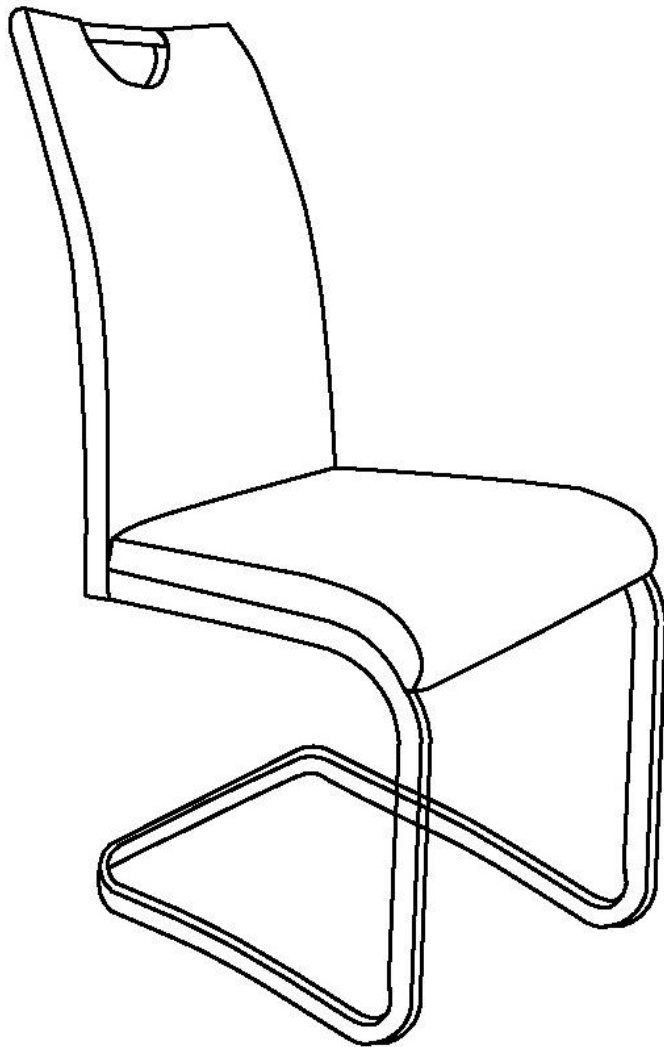

Typ: Nr. 086-8848

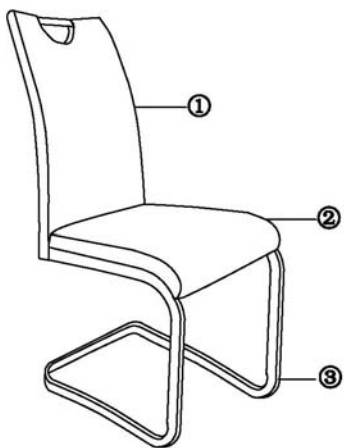



			
#4	M6*16	M6	M6*25
Ax1	Bx6	Cx8	Dx2

2

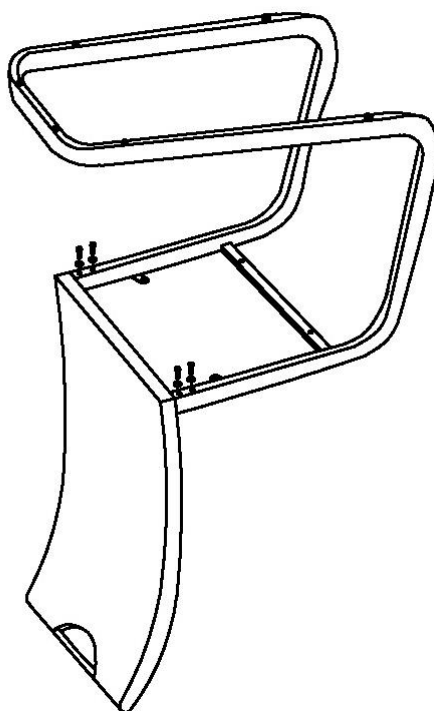
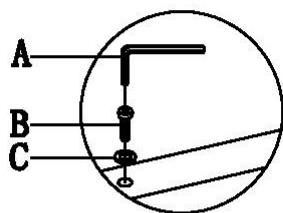

3

