

JASMIN 35-845-__-6

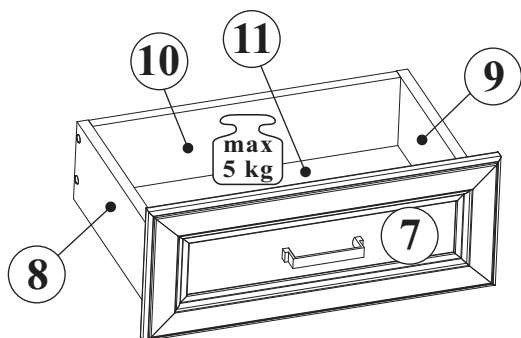

NO	Dim. (mm)			Col.-No	Qty
1	1992	365	16	2/2	1
2	1992	365	16	2/2	1
3	554	345	16	1/2	1
4	588	392	16	1/2	1
5	554	344	16	1/2	1
6	554	335	16	1/2	3
7	496	200	22	1/2	3
8	300	120	16	1/2	3
9	300	120	16	1/2	3
10	434	106	16	1/2	3
11	304	446	3	1/2	3
13	608	90	25	1/2	1

NO	Dim. (mm)			Col.-No	Qty
14	365	90	10	2/2	2
12	1902	43	19	2/2	2
17	641	67	22	1/2	1
15	418	67	22	1/2	1
16	418	67	22	1/2	1
18	1923	566	3	2/2	1

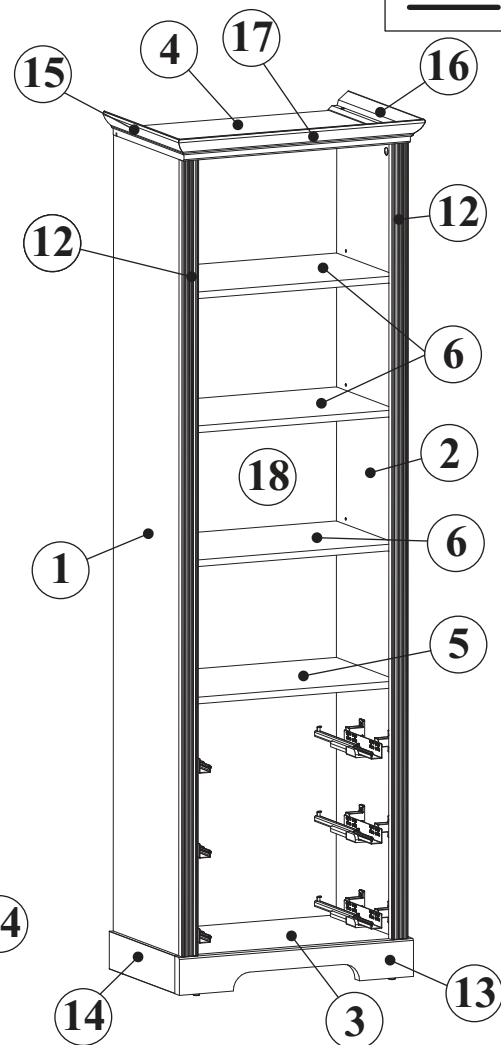
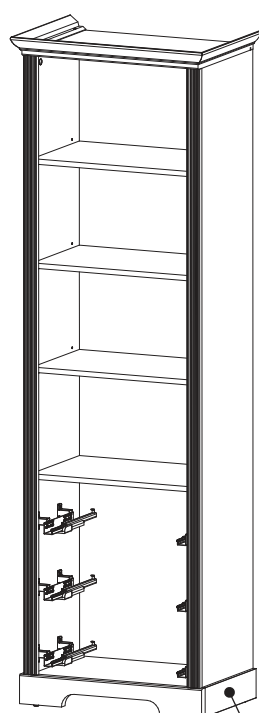
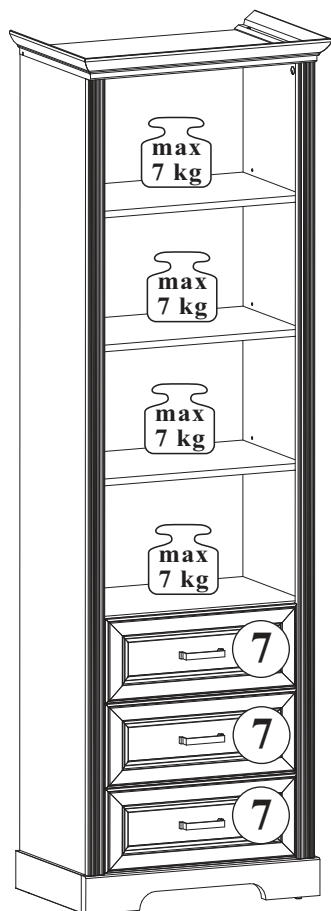
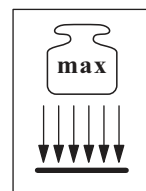





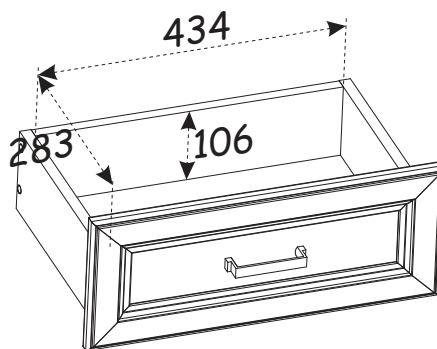
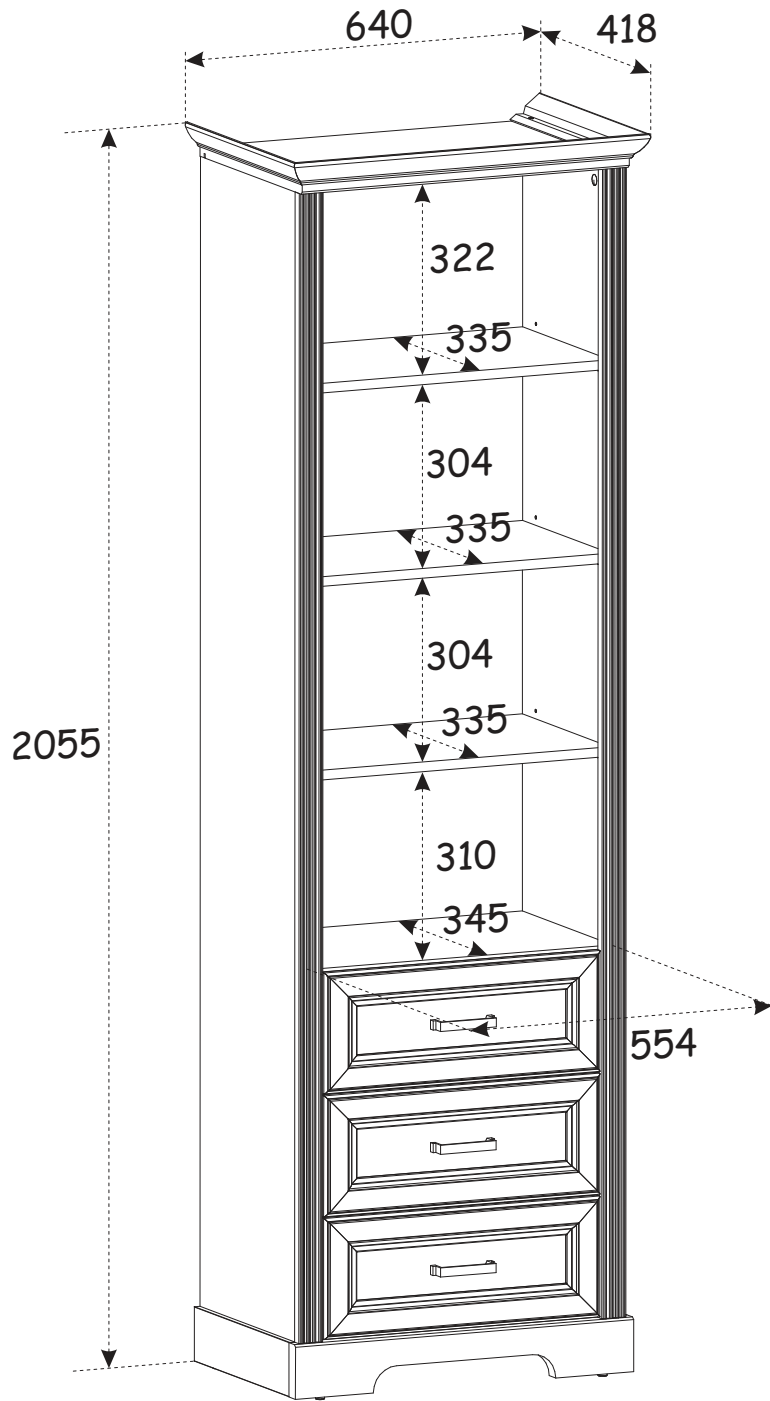

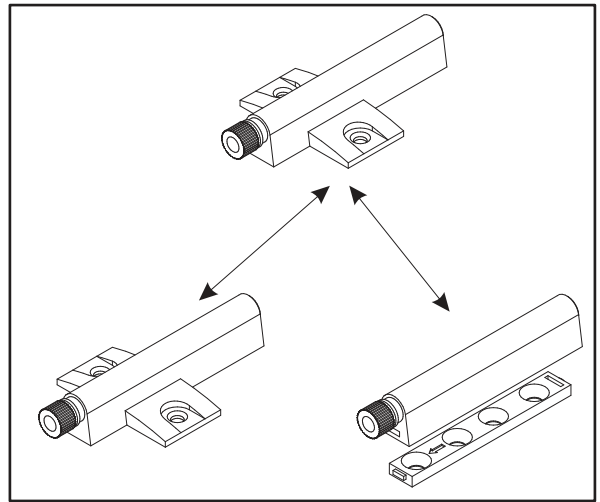
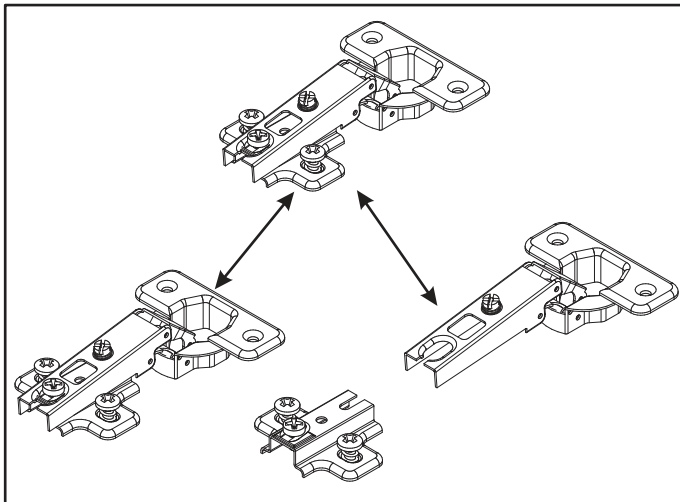
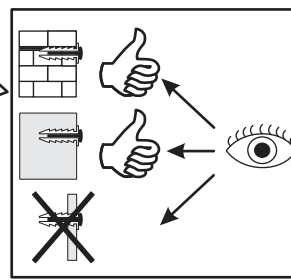
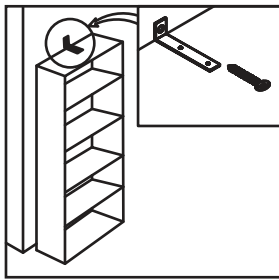
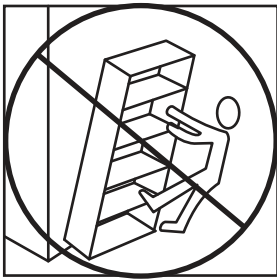
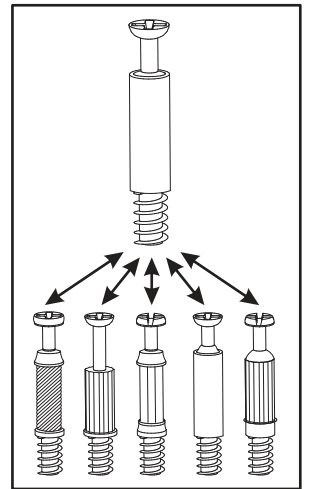
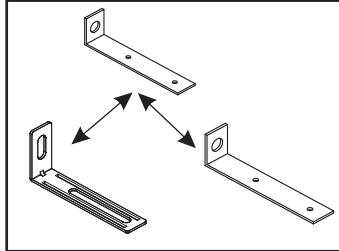
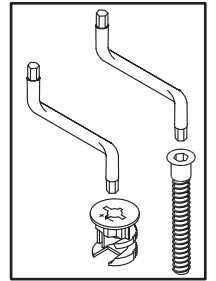
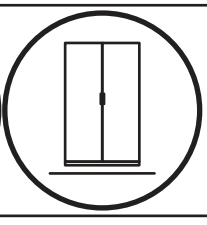
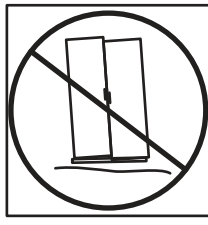
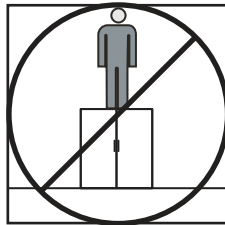
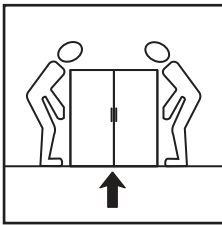
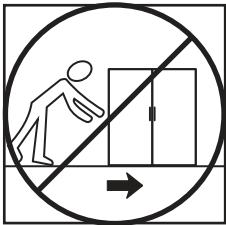
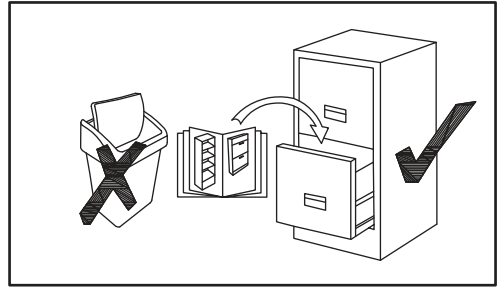
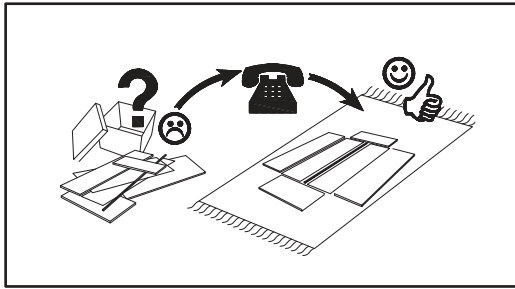
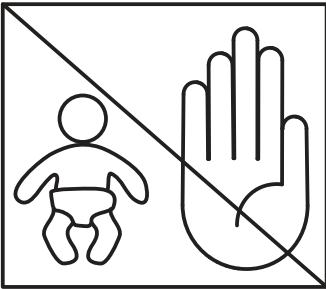
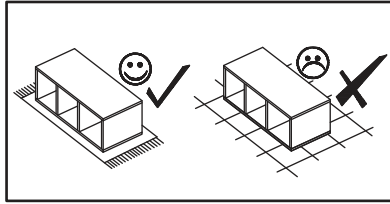
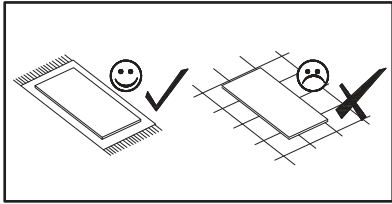

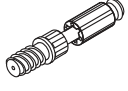





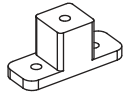

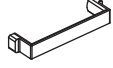
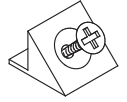
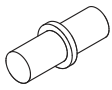

180 min





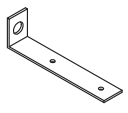
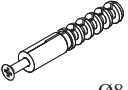

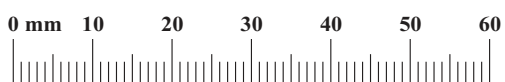

A1 x36  ø8x36	B4 x32 	B5 x32  Ø15x12	G5 x30 	B11 x12  Ø7x50	G4 x12 
QU x3  L-300mm	H1 x12 	D14 x24  ESØ6x13	C19 x3 	S1 x21 	G7 x12 
I2 x4 	D34 x6  M4x16	UP11 x6  UPØ4x20	D10 x2  USØ3,5x13	UP13 x18  UPØ3x16	UP15 x6  UPØ3.5x22
D8 x12  ESØ5x13	L1 x1 	KR1 x1  Ø8	G2 x1 		

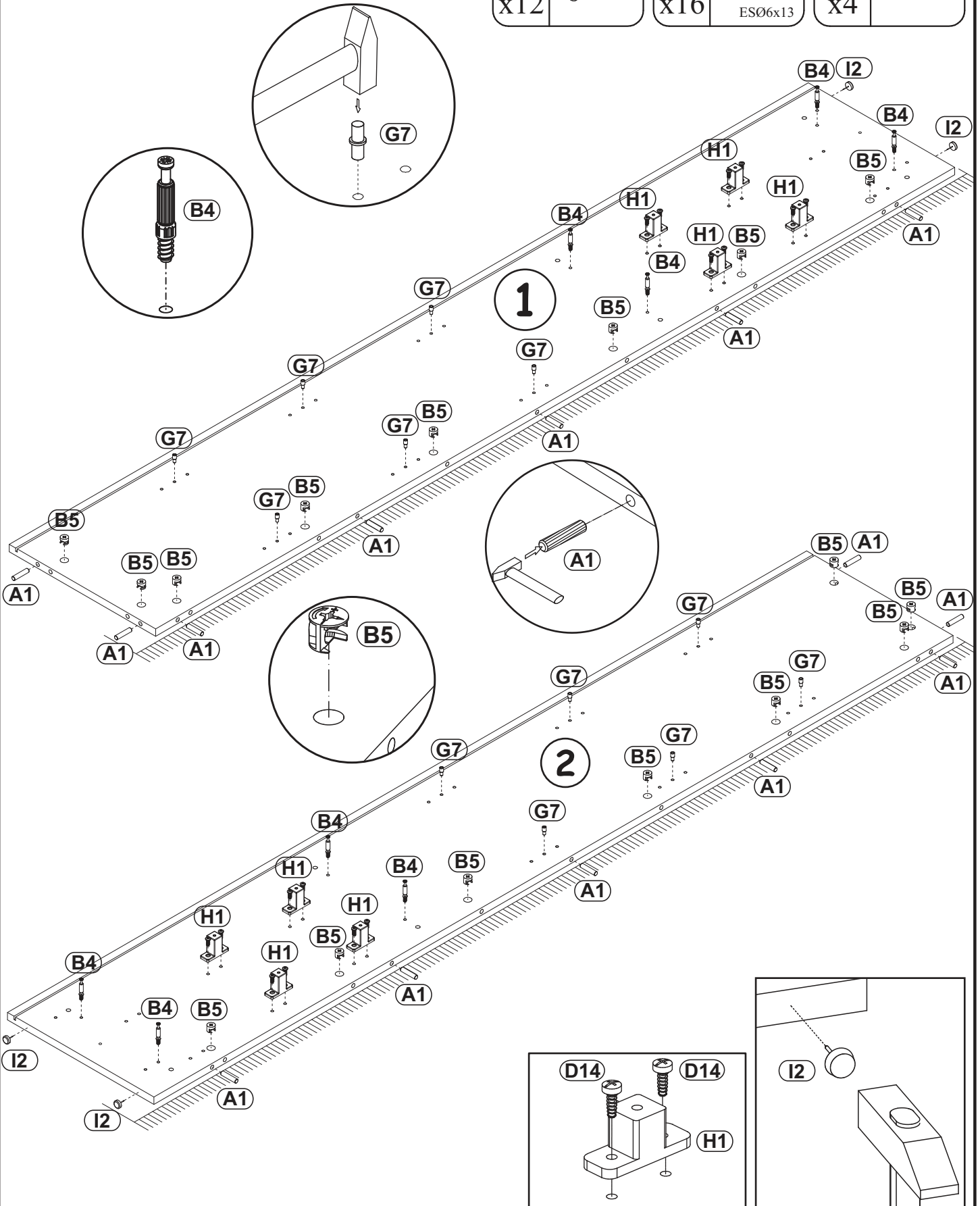
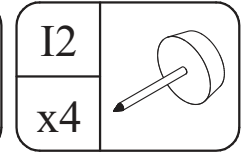
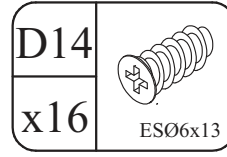
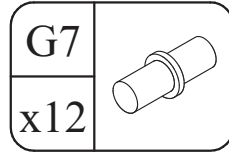
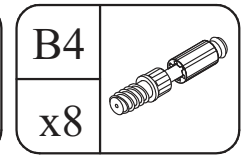
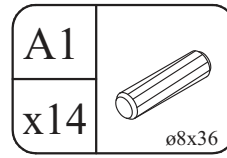
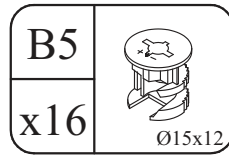
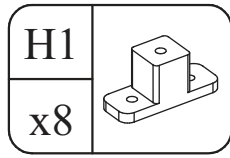

1

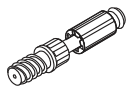

I2		B4	
x2		x14	

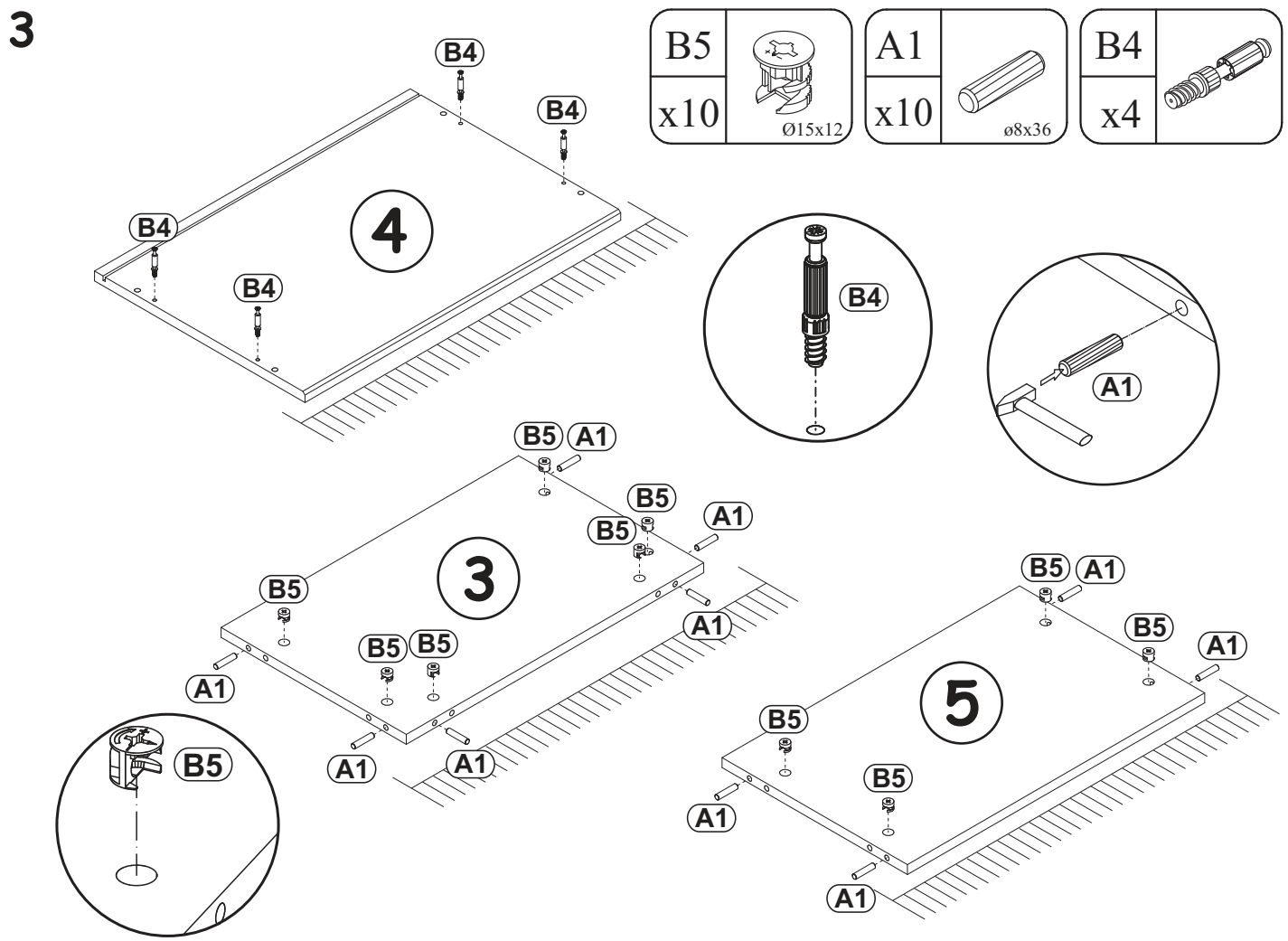
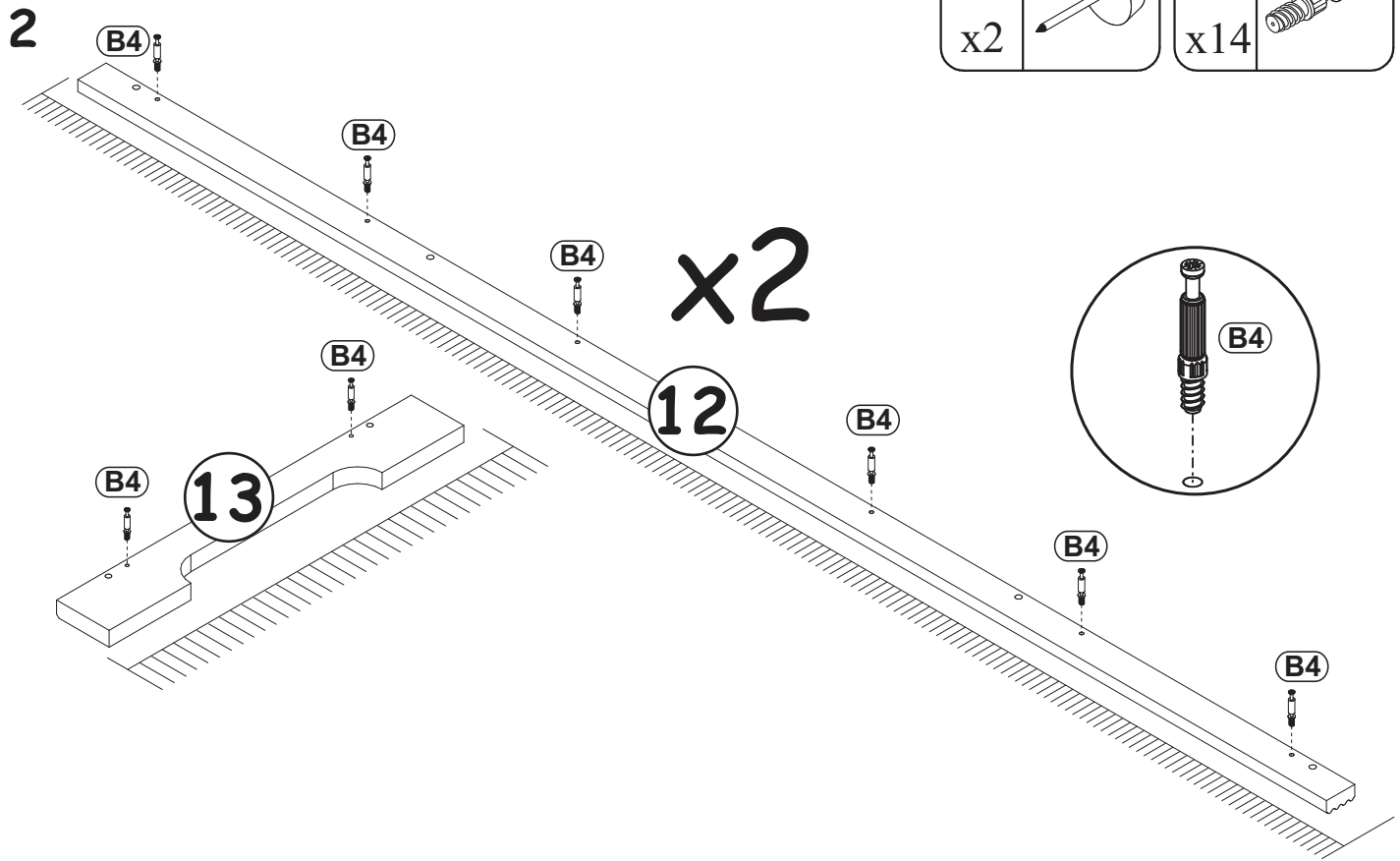

4

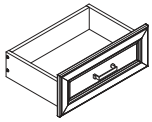

B5	
x6	Ø15x12

A1	
x12	ø8x36

B4	
x6	

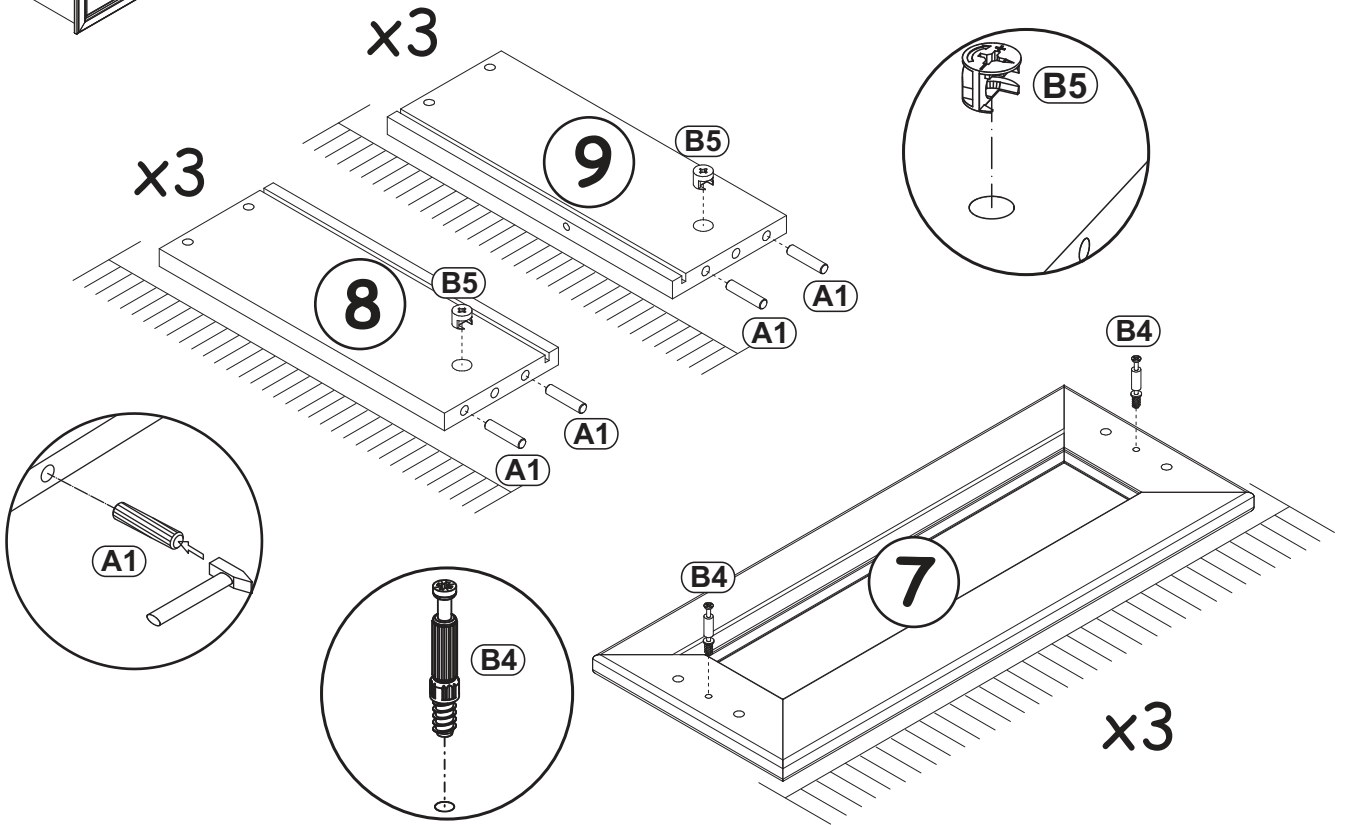

5

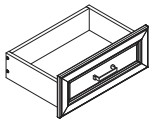

B11	
x12	Ø7x50

G4	
x12	

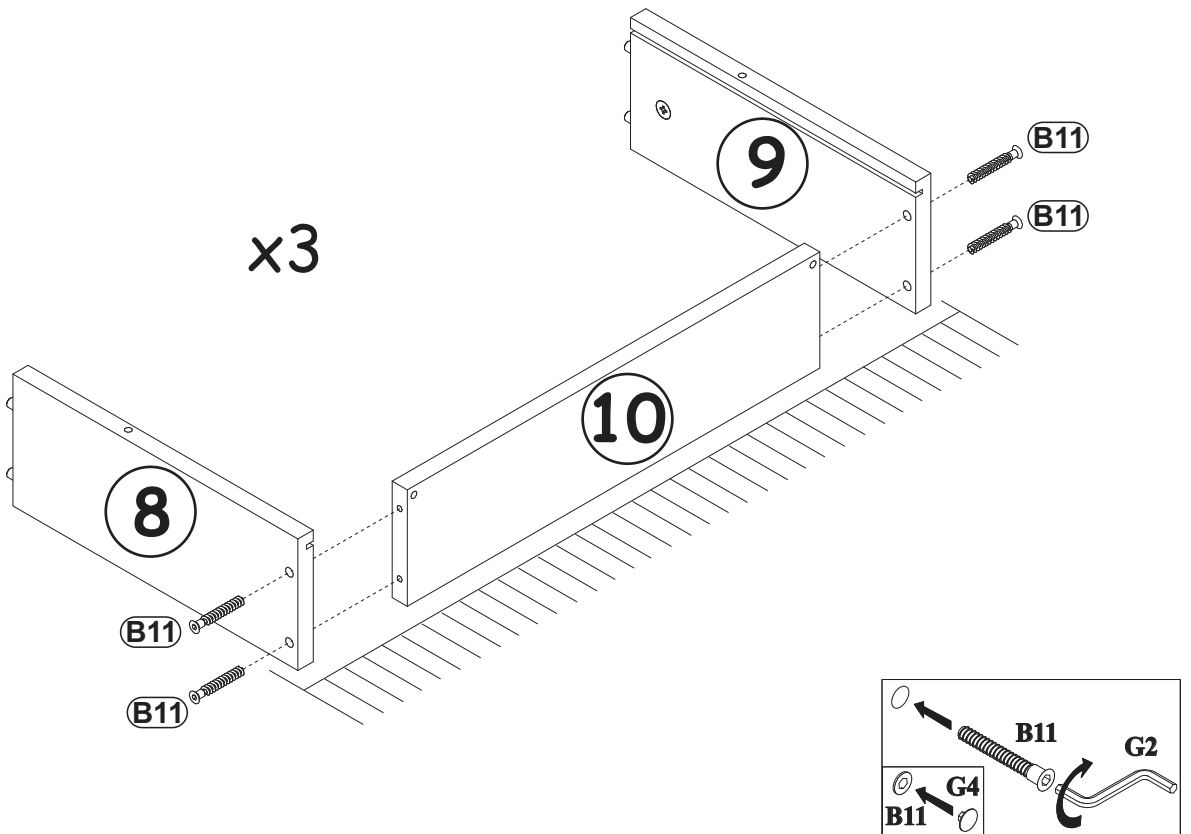



6

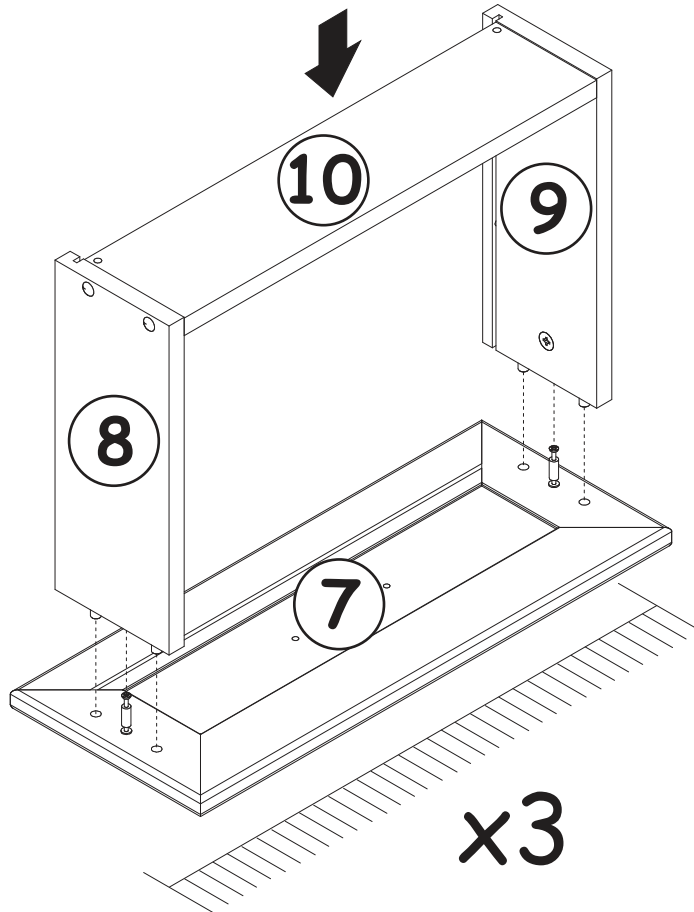
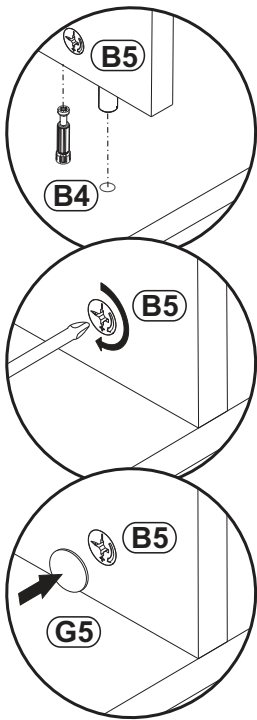

7

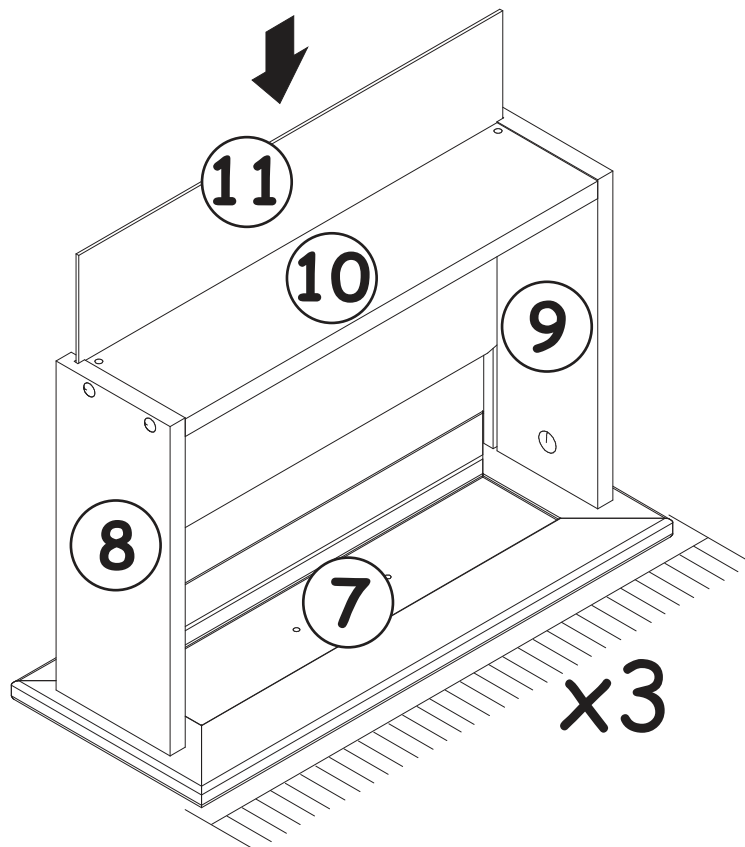

8

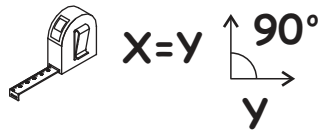
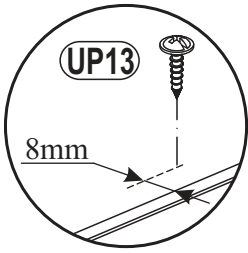

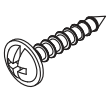

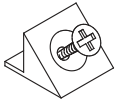
UP13	
x12	UP03x16

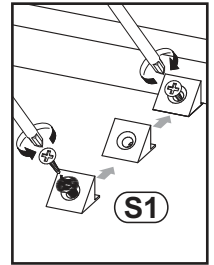
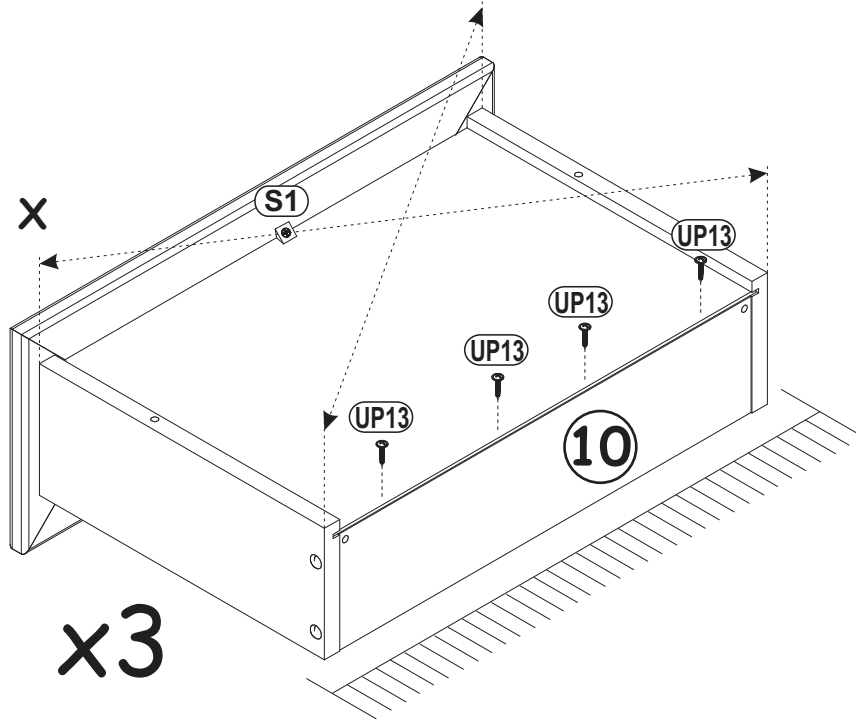
S1	
x3	

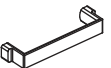

9

C19	
x3	

D34	
x6	M4x16

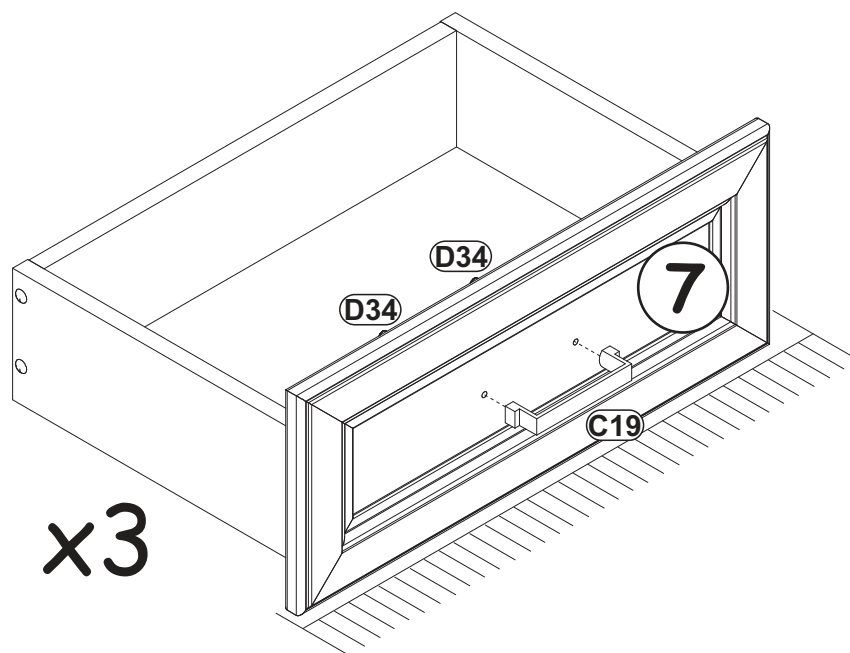

G5

x10



10

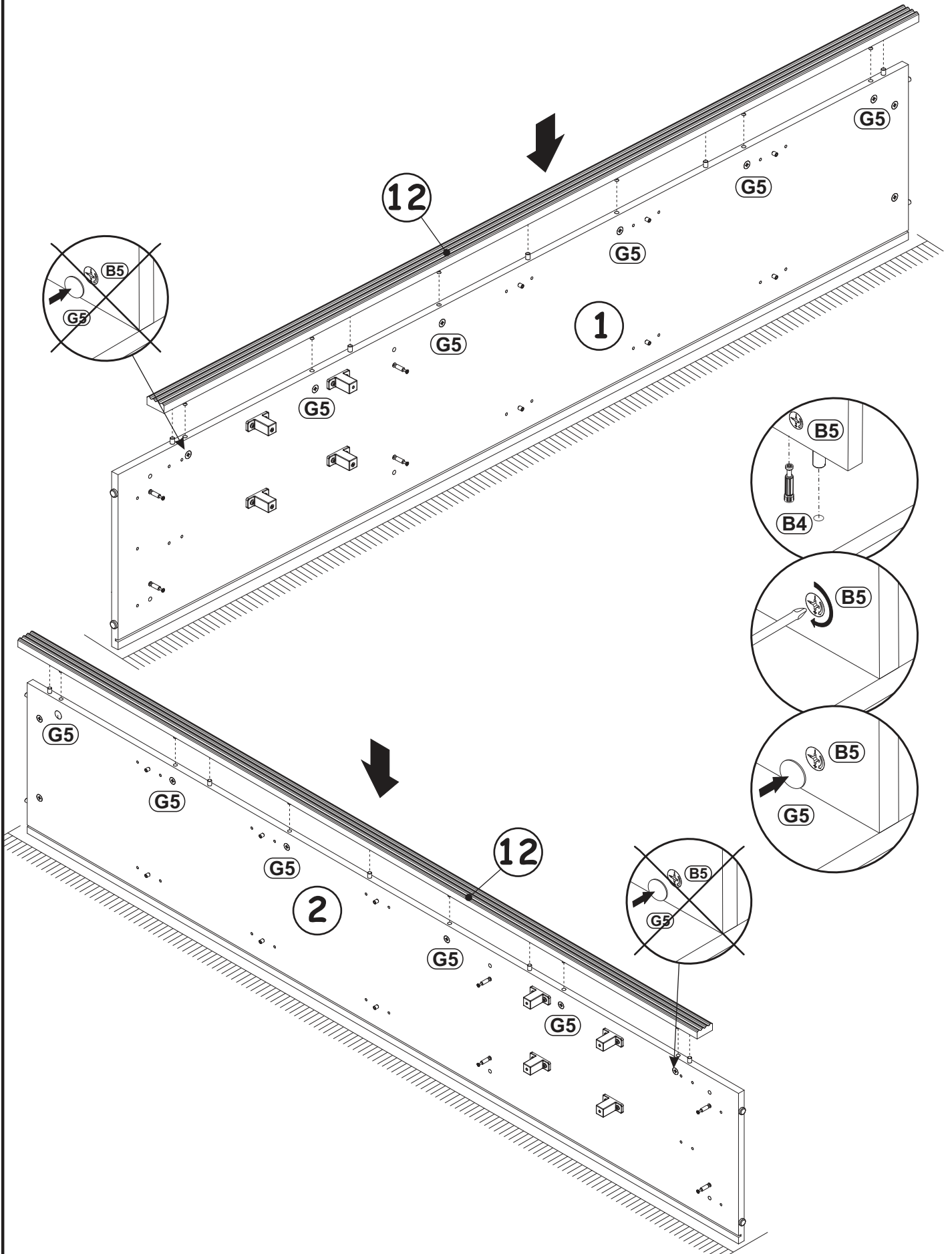

11

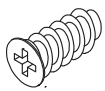
D14	 ESØ6x13
x4	

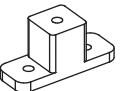
H1	
x2	

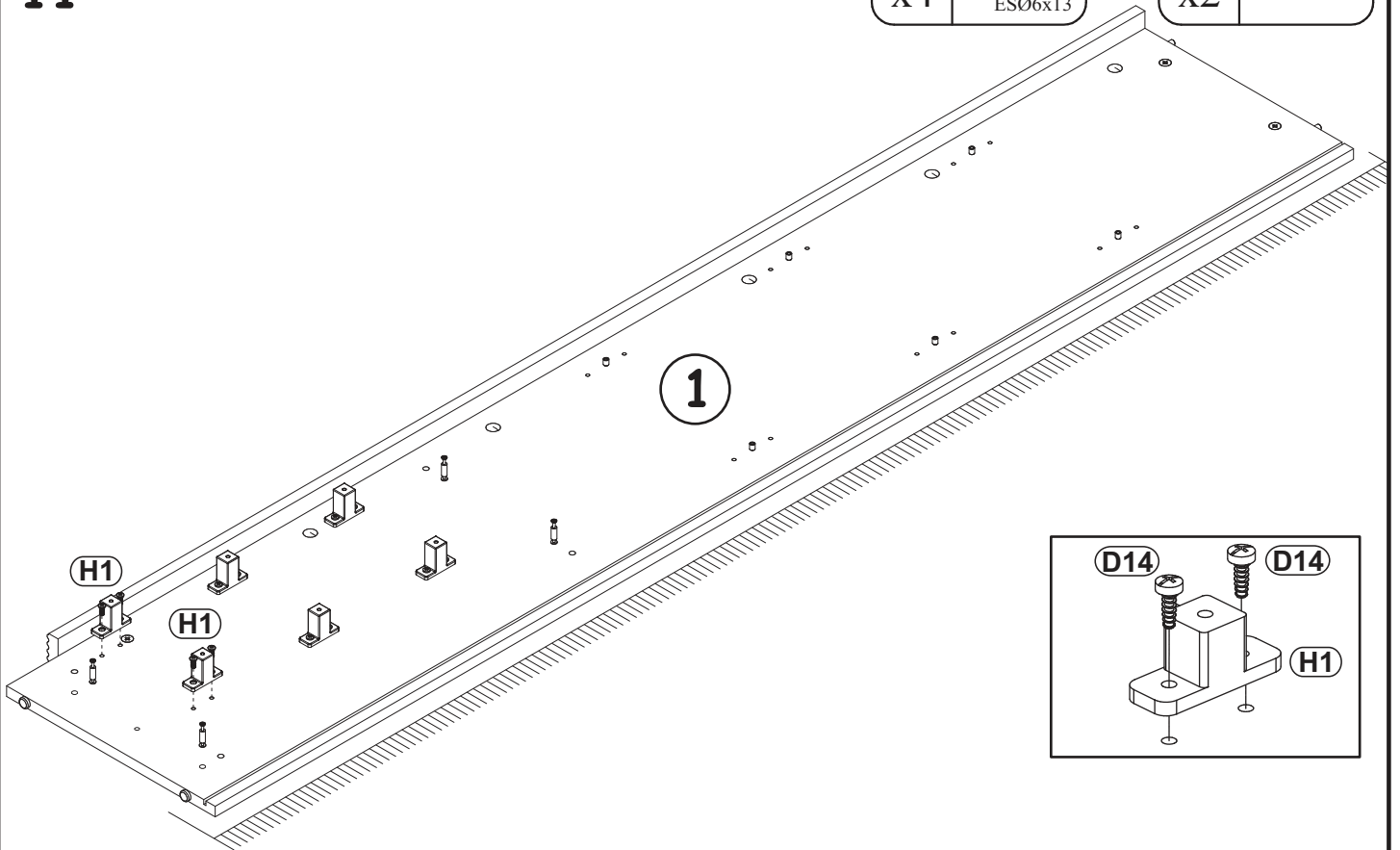

12

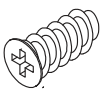
D14	 ESØ6x13
x4	

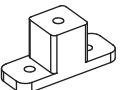
H1	
x2	

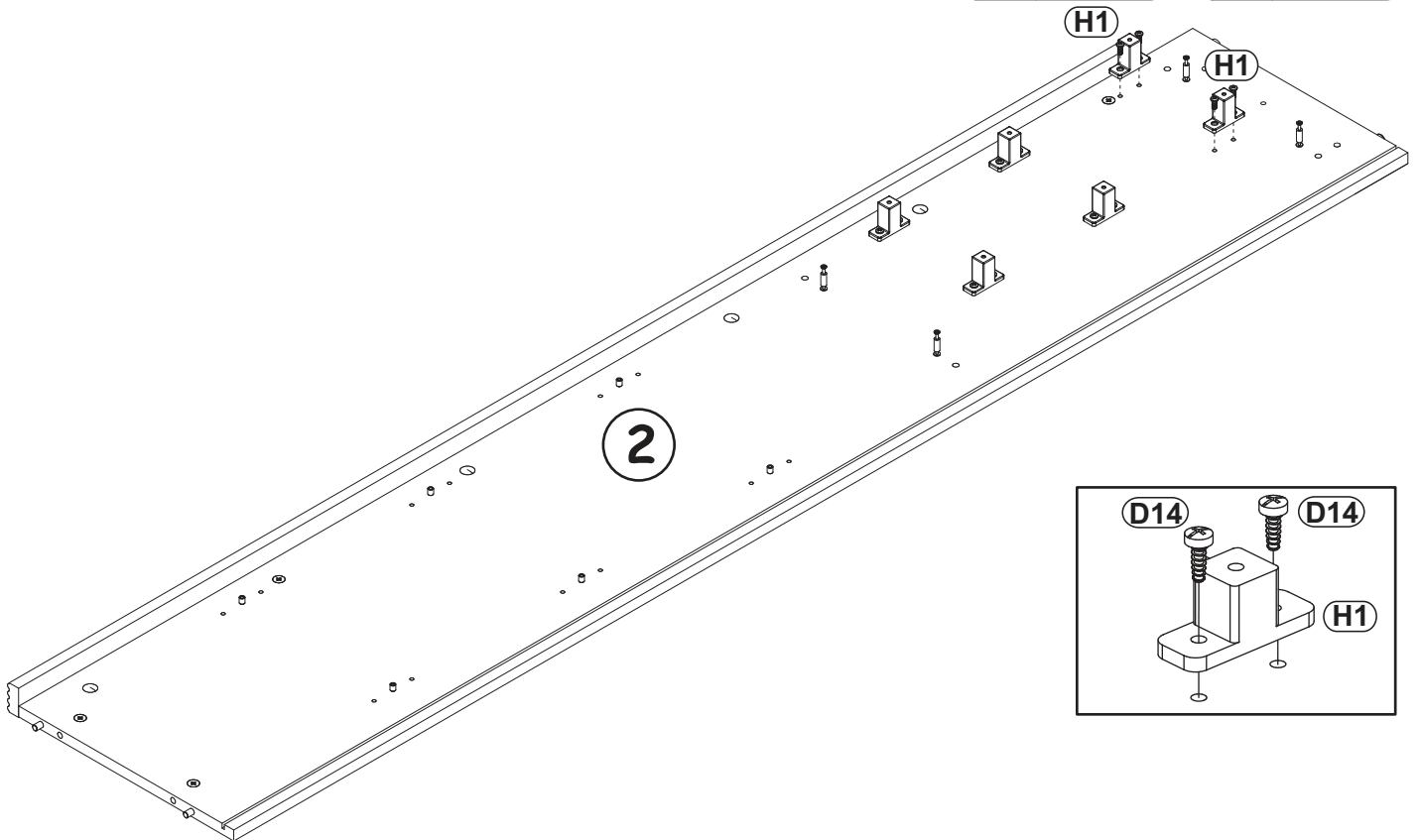

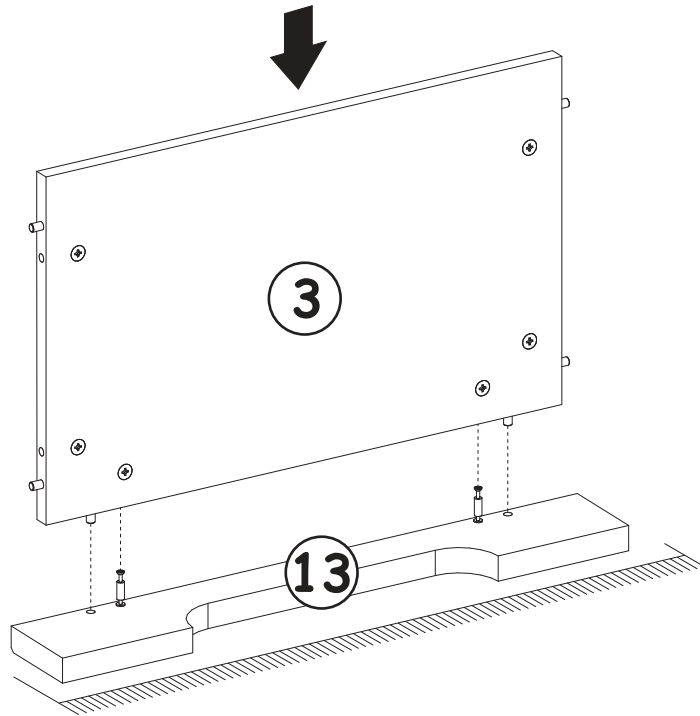

G5	
x2	

13

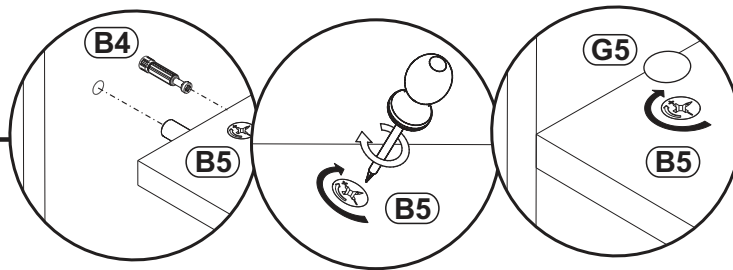

14



G5	
x8	

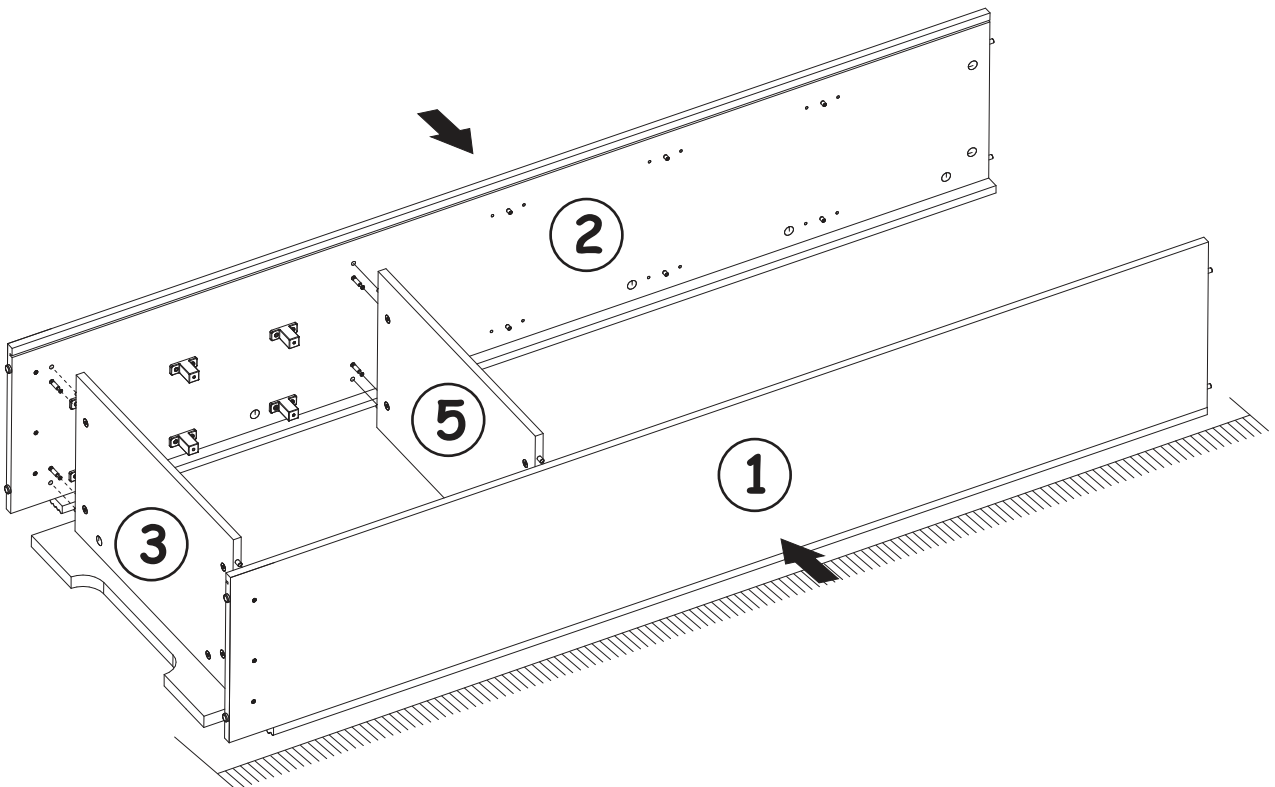

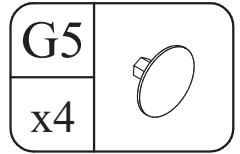
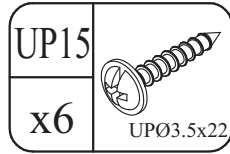

15

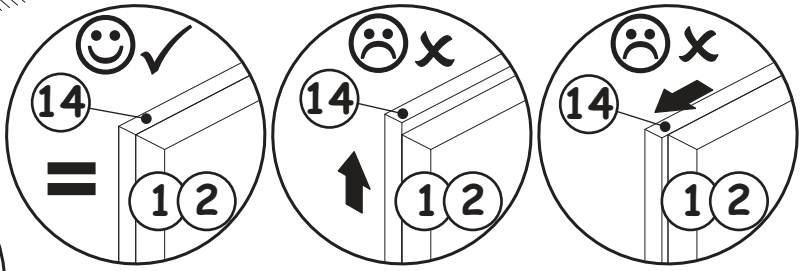
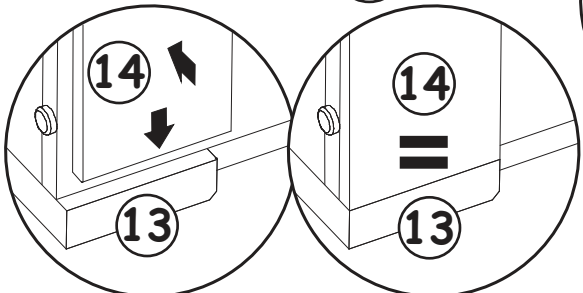
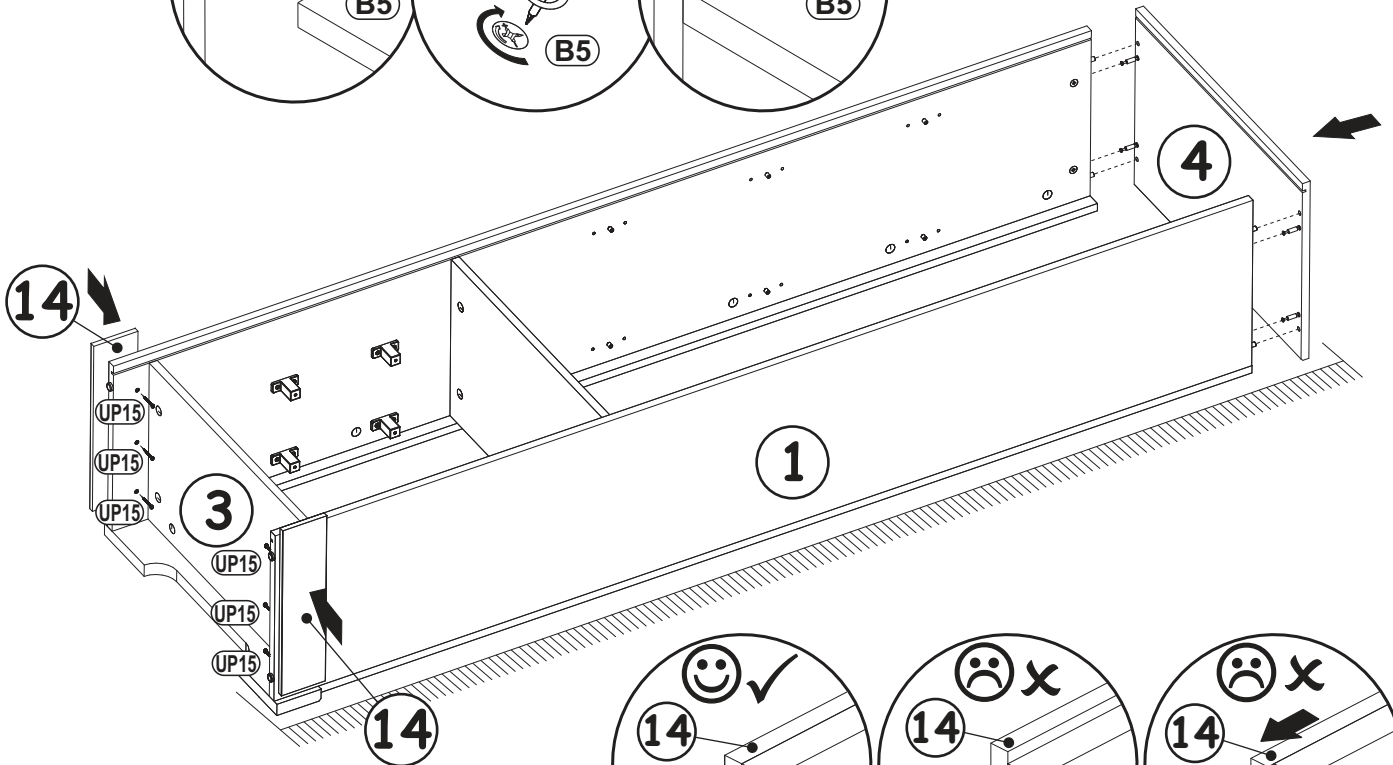
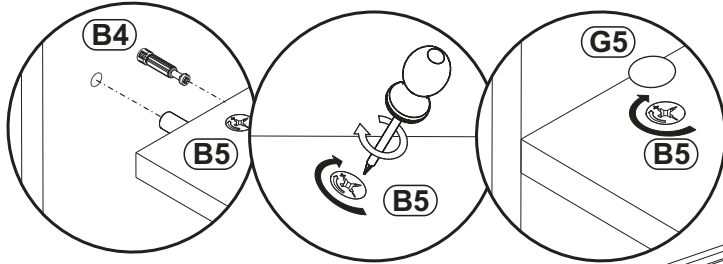

16

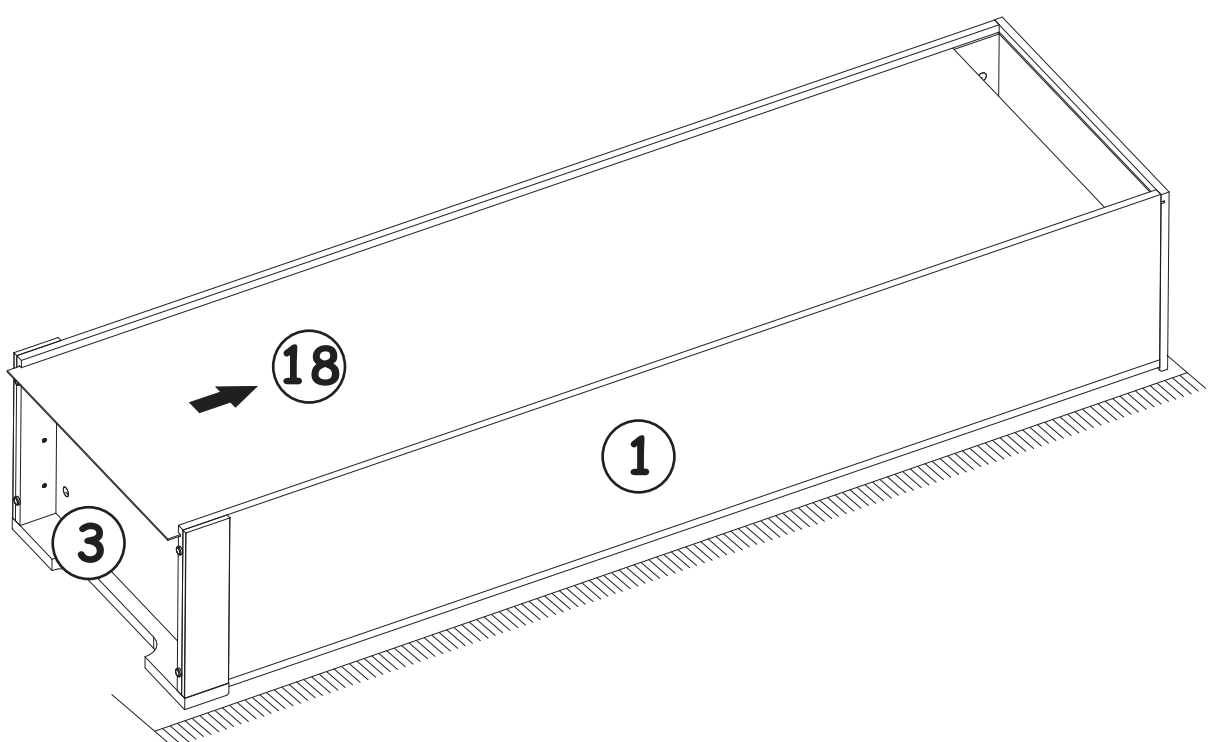



17

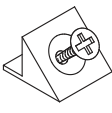

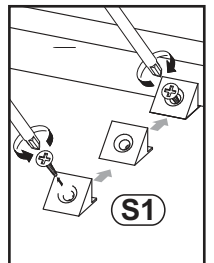
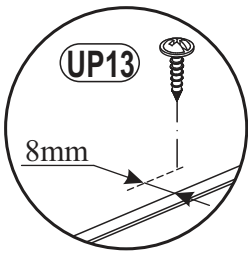
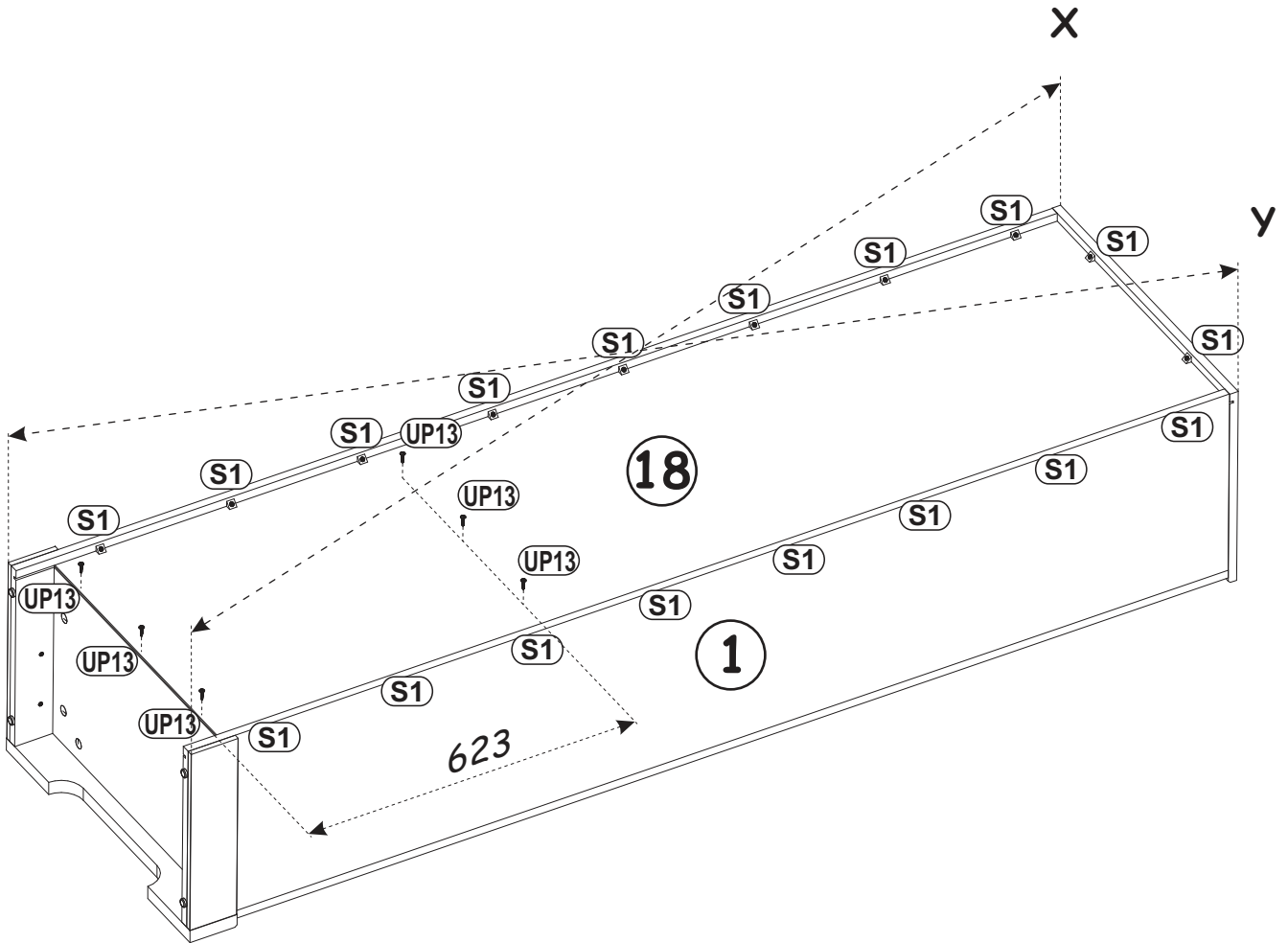
UP13	 UPØ3x16	S1	
x6		x18	

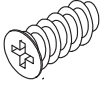

D8		QU	
x12	ES05x13	x3	L-300mm

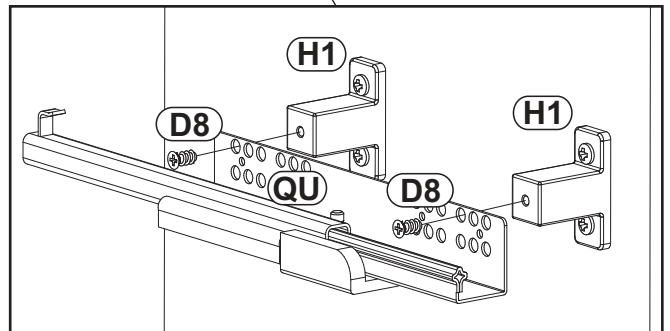
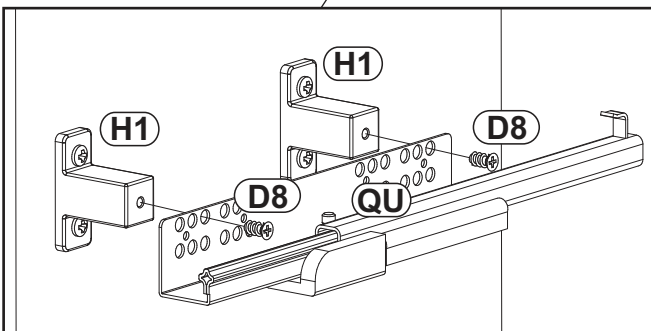
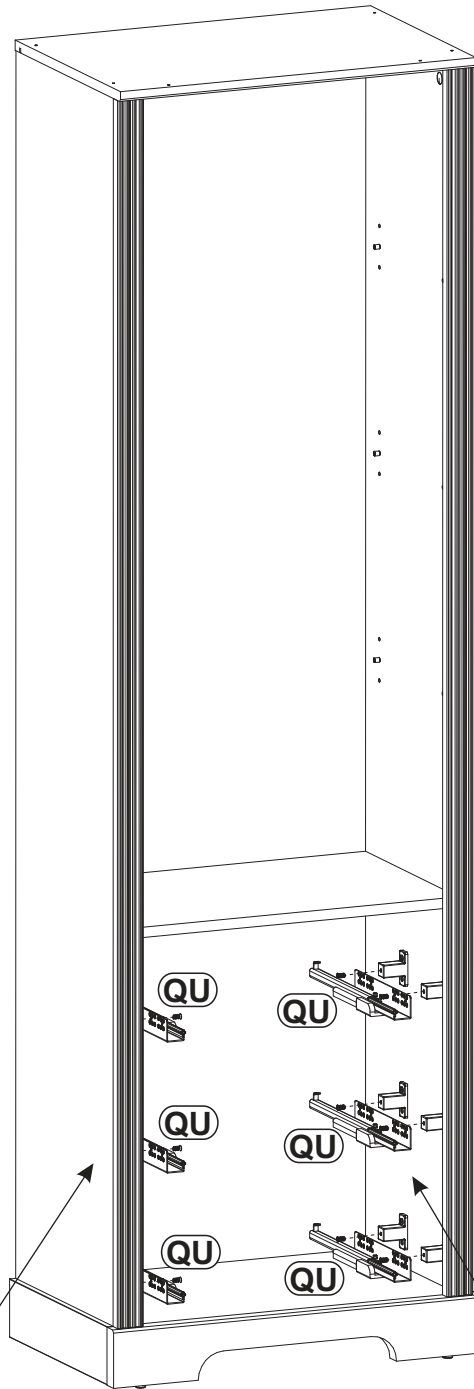

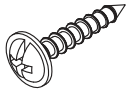

19

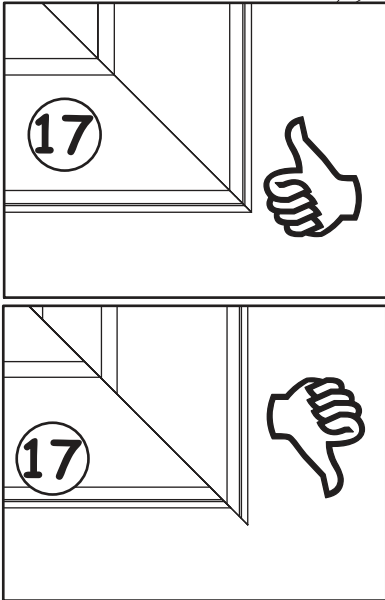
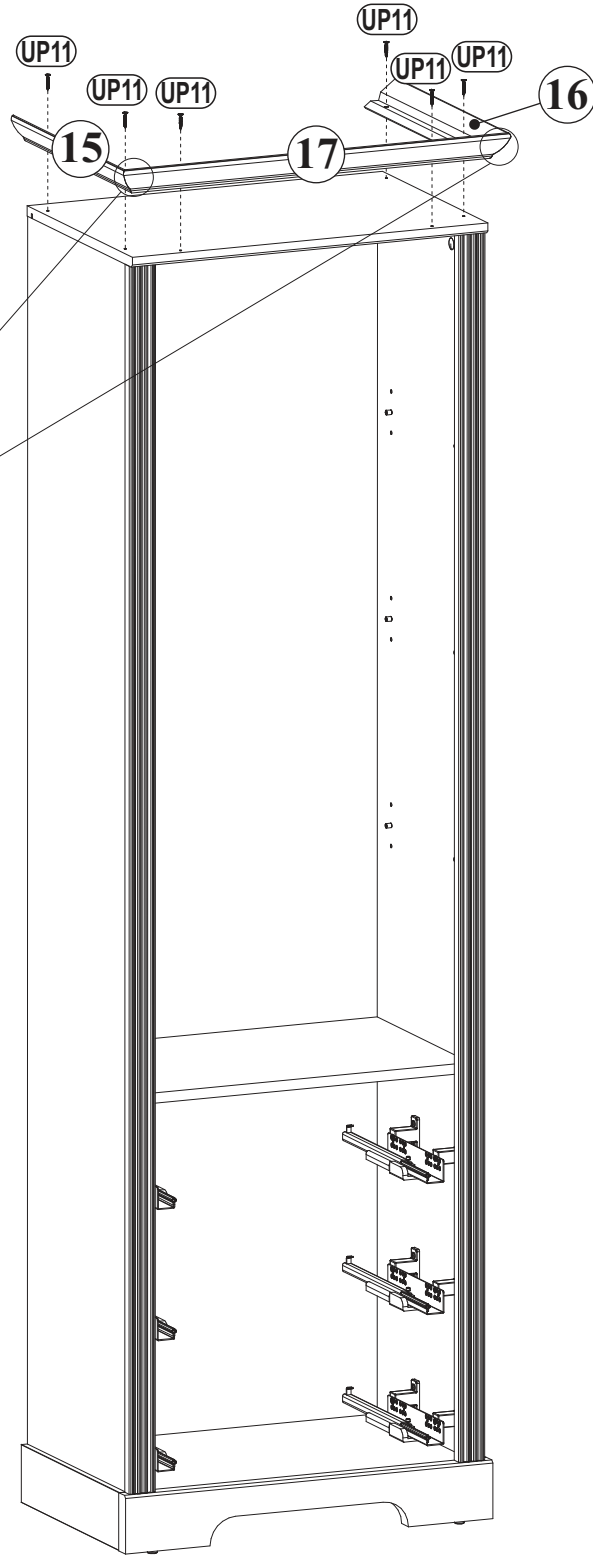
UP11	 UPØ4x20
x6	

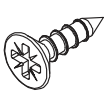
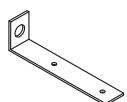

20

D10		L1		KR1	
x2	USØ3,5x13	x1		x1	Ø8

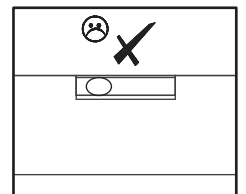
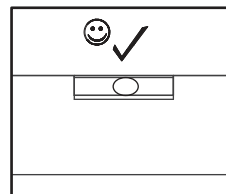
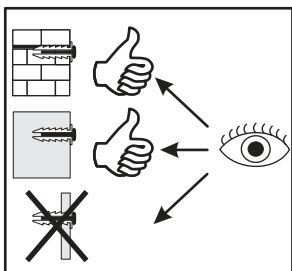
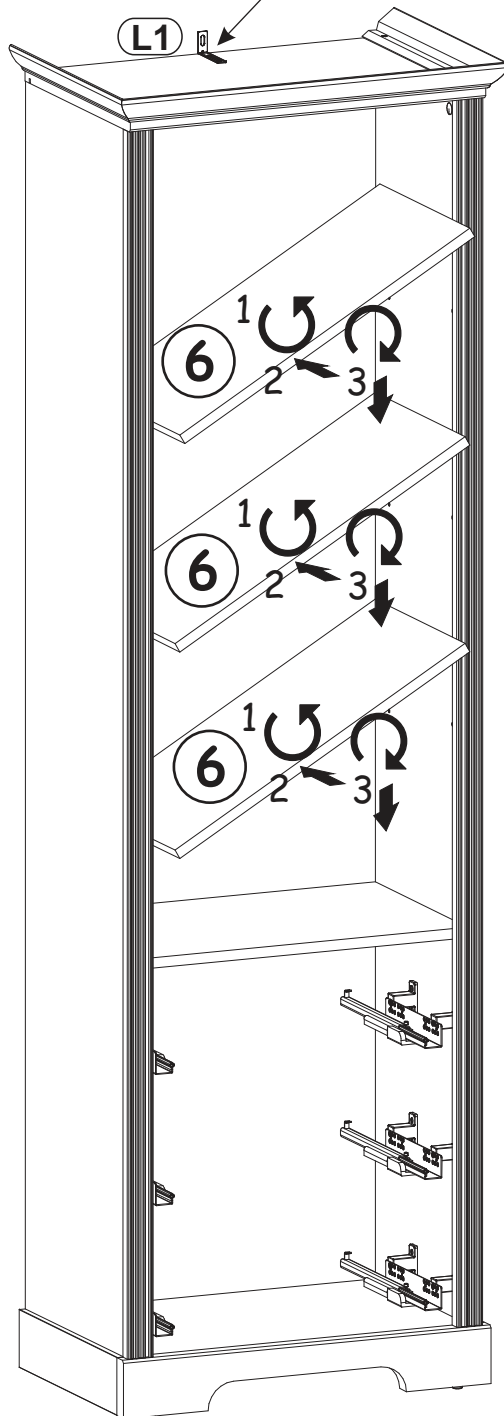
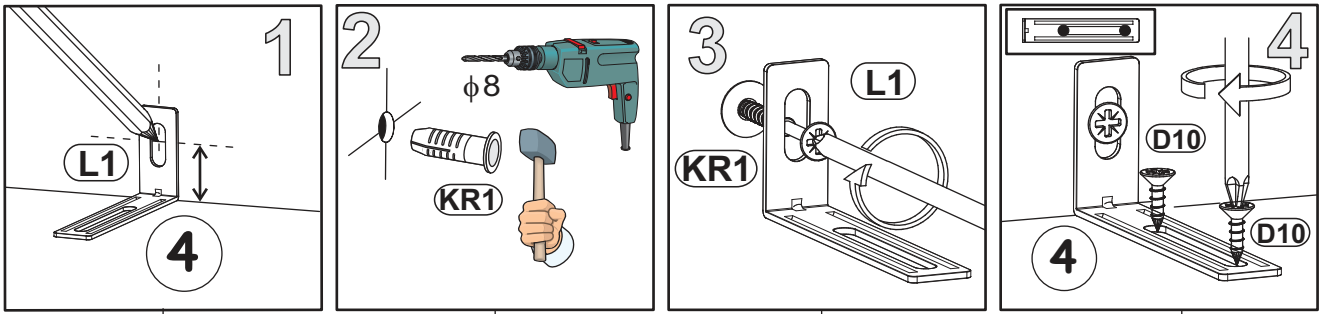

21

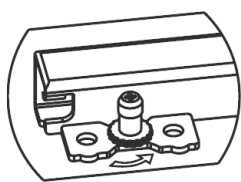
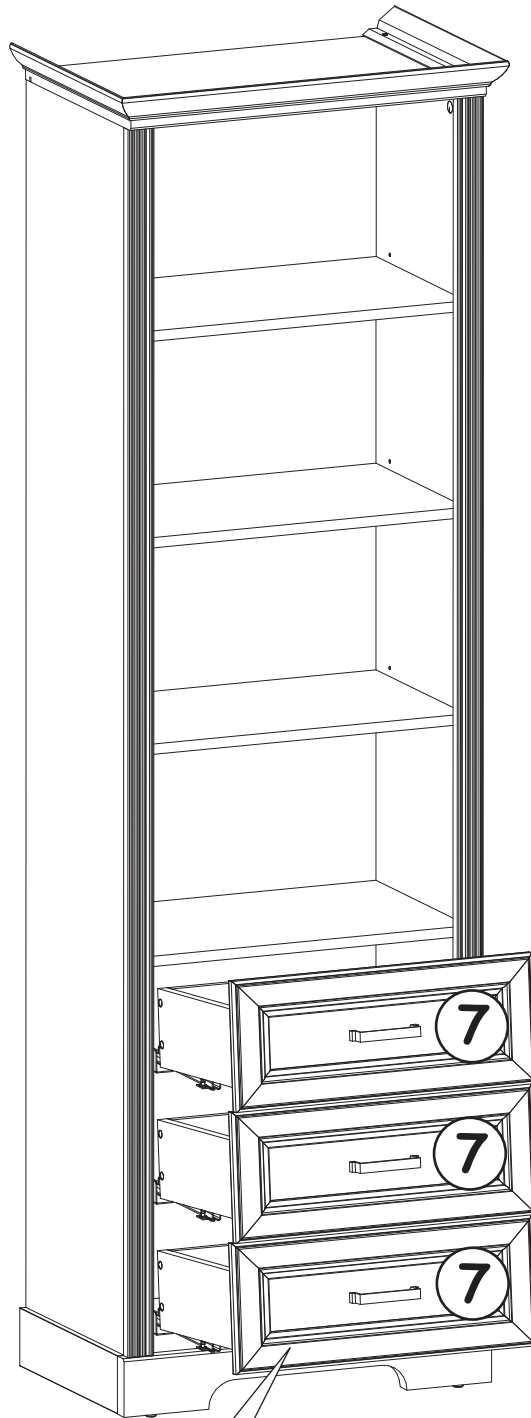

↑ +4 mm

