

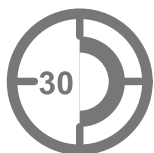

LIVING

**D-** Montageanleitung**GB-** Assembly instructions**F-** Instructions de montage**PL-** Instrukcja montażu**RU-** Инструкция по монтажу**NL-** Montagehandleiding**TR-** Montaj talimatı**RO-** Instrucțiuni de montaj**IT-** Istruzioni per il montaggio**SK-** Návod na montáž**CZ-** Návod k montáži**HU-** Szerelési útmutató**BG-** Ръководство за монтаж**P-** Instruções de montagem**ES-** Instrucciones de montaje**SRB-** Uputstvo za montažu**SLO-** Navodila za vgradnjo**HR-** Upute za montažu**LT-** Montavimo instrukcija**LV-** Montāžas instrukcija**EST-** Montaažijuhend**S-** Monteringsanvisning

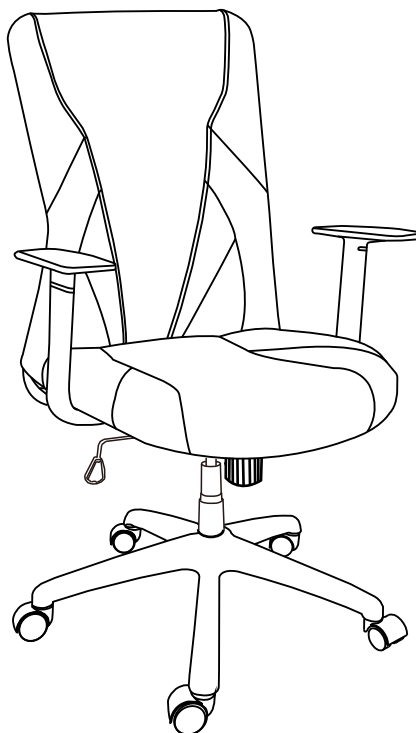

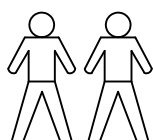
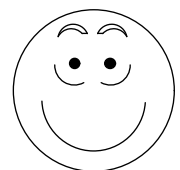
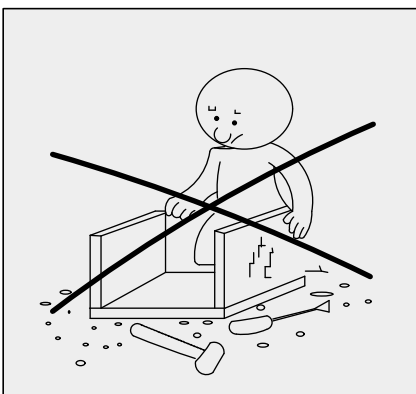
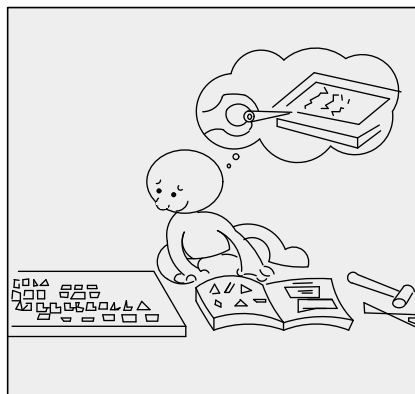
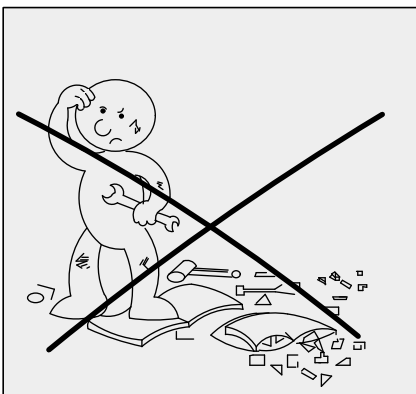
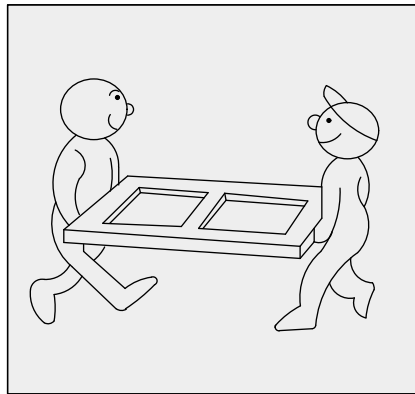
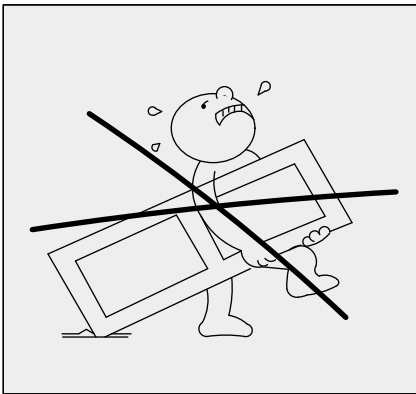
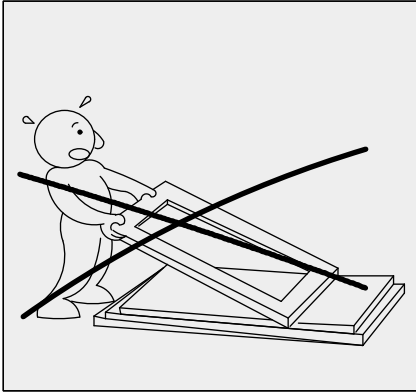
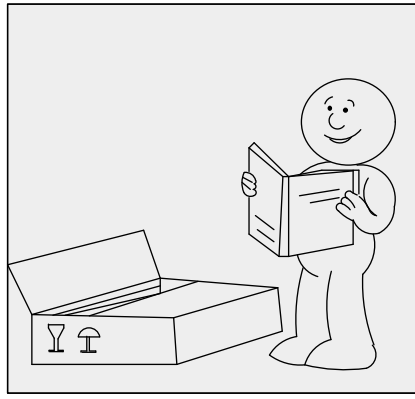
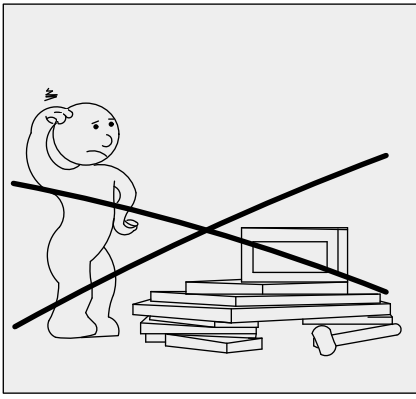

## ERSATZTEILSERVICE

Spare parts service/ Service de pièces de rechange/ Servizio ricambi/  
Service reserveonderdelen/ Serwis części zamiennych/ Serviciul de  
piese de schimb/ Обслуживание запасными частями/ Servis náh-  
radných dielov/ Servis náhradních dílů/ yedek parçalar/ Pótalkatrész-  
szolgáltatás



### Ist etwas defekt oder fehlt etwas?

### Nutzen Sie unseren Ersatzteilservice und scannen Sie folgenden QR-Code:

Is something defective or missing?

Use our spare parts service and scan the following QR code:

Quelque chose est-il défectueux ou manquant ?

Utilisez notre service de pièces détachées et scannez le code QR suivant :

C'è qualcosa di difettoso o mancante?

Usa il nostro servizio di ricambi e scansiona il seguente codice QR:

Is er iets defect of ontbreekt er iets?

Maak gebruik van onze onderdelen service en scan de volgende QR code:

Czy coś jest uszkodzone lub czegoś brakuje?

Skorzystaj z naszego serwisu części zamiennych i zeskanuj poniższy kod QR:

Este ceva defect sau lipsește?

Utilizați serviciul nostru de piese de schimb și scanați următorul cod QR:

Что-то неисправно или отсутствует?

Воспользуйтесь нашим сервисом запасных частей и отсканируйте следующий QR-код:

Je niečo chybné alebo chýba?

Využite náš servis náhradných dielov a naskenujte nasledujúci QR kód:

Je něco vadné nebo chybí?

Využijte náš servis náhradních dílů a naskenujte následující QR kód:

Bir şey mi kırıldı yoksa eksik bir şey mi var?

Yedek parça servisimizi kullanın ve aşağıdaki QR kodunu tarayın:

Valami hibás vagy hiányzik?

Használja alkatrész-szolgáltatásunkat, és szkennelje be az alábbi QR-kódot:









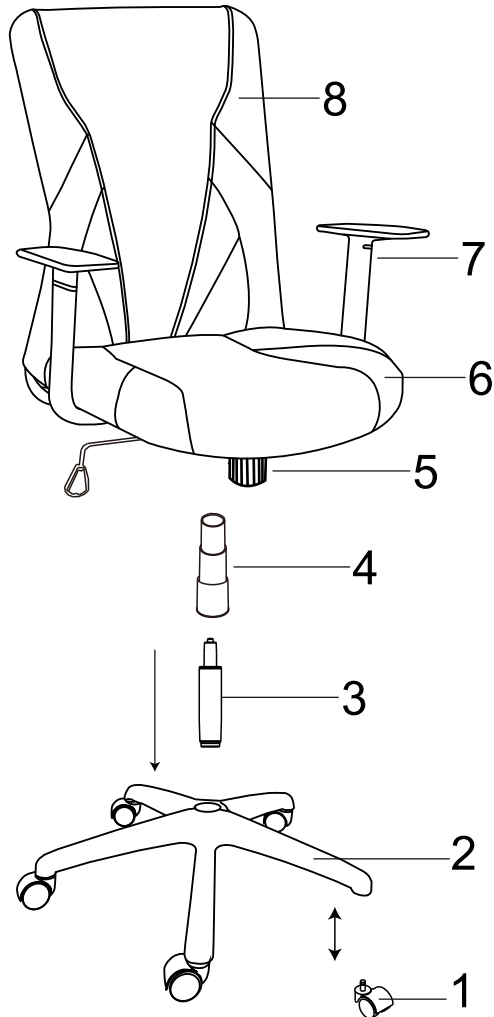



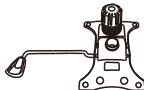

### FLASH 01

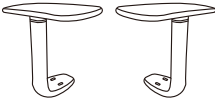

**Servicekarte/ Сервизна карта/ Carte service/ Servisní karta/ Service card/ Tarjeta de servicio/ Servisna kartica/ Teeninduskaart/ Szervizlevél/ Servis karti/ Scheda di servizio/ Techninês priežiūros kortelė/ Servisa karte/ Servicekaart/ Servisna kartica/ Cartão de serviços/ Karta serwisowa/ Carte de service/ Сервис-карта/ Servicekort/ Servisna kartica/ Servisná karta**

FLASH 01



1 	2 	2a 	3 	4 
5 	6 	7 	8 	
A  M6*20MM/8PCS	B  M6*35MM/6PCS	C  M6*25MM/1PC	D  M6*15*1MM/6PCS	
E  M5/1PC	F  M4/1PC			

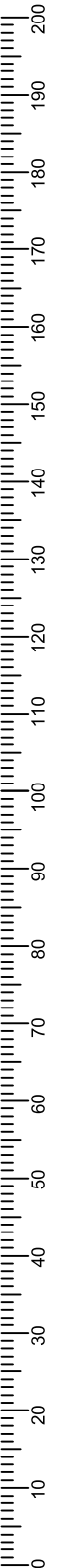

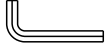

1

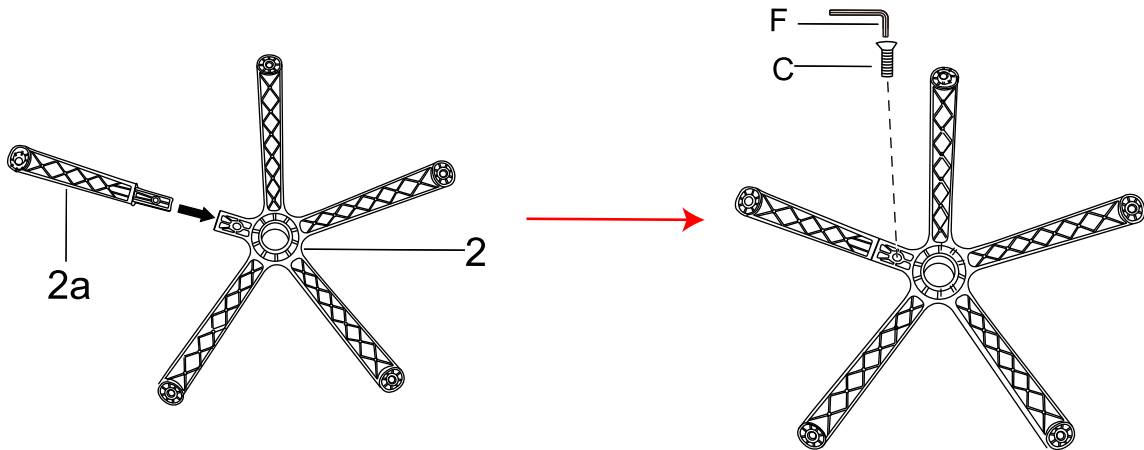
C	 M6*25MM/1PC
F	 M4/1PC



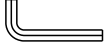

2

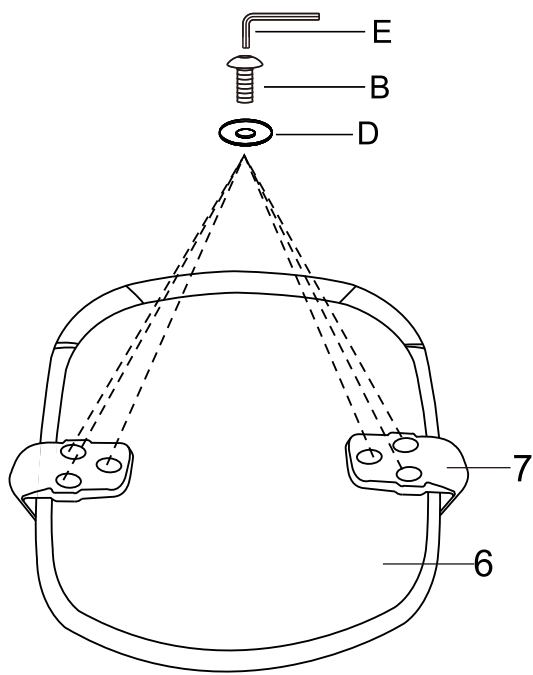
B	 M6*35MM/6PCS
D	 M6*15*1MM/6PCS
E	 M5/1PC

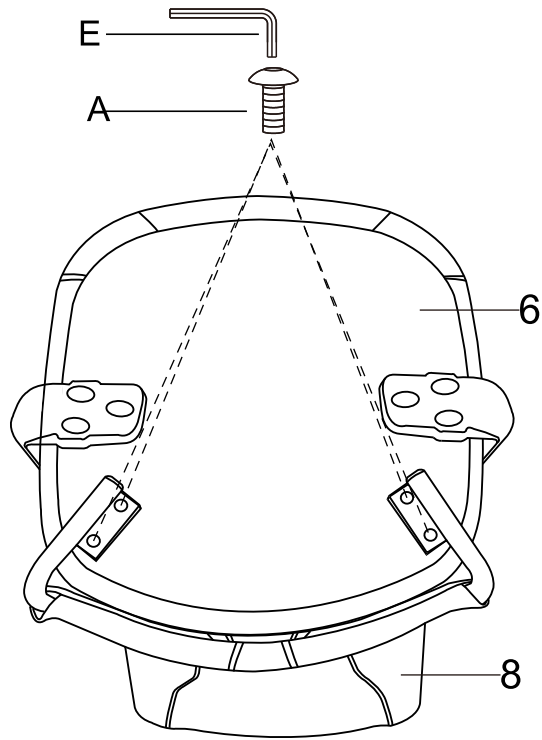

3



A   
M6\*20MM/4PCS

E   
M5/1PC

4

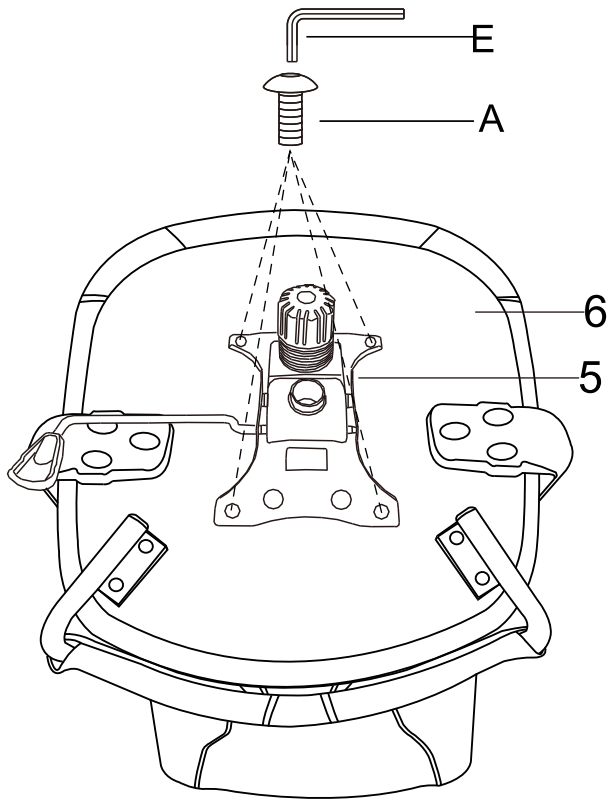

A   
M6\*20MM/4PCS

E   
M5/1PC

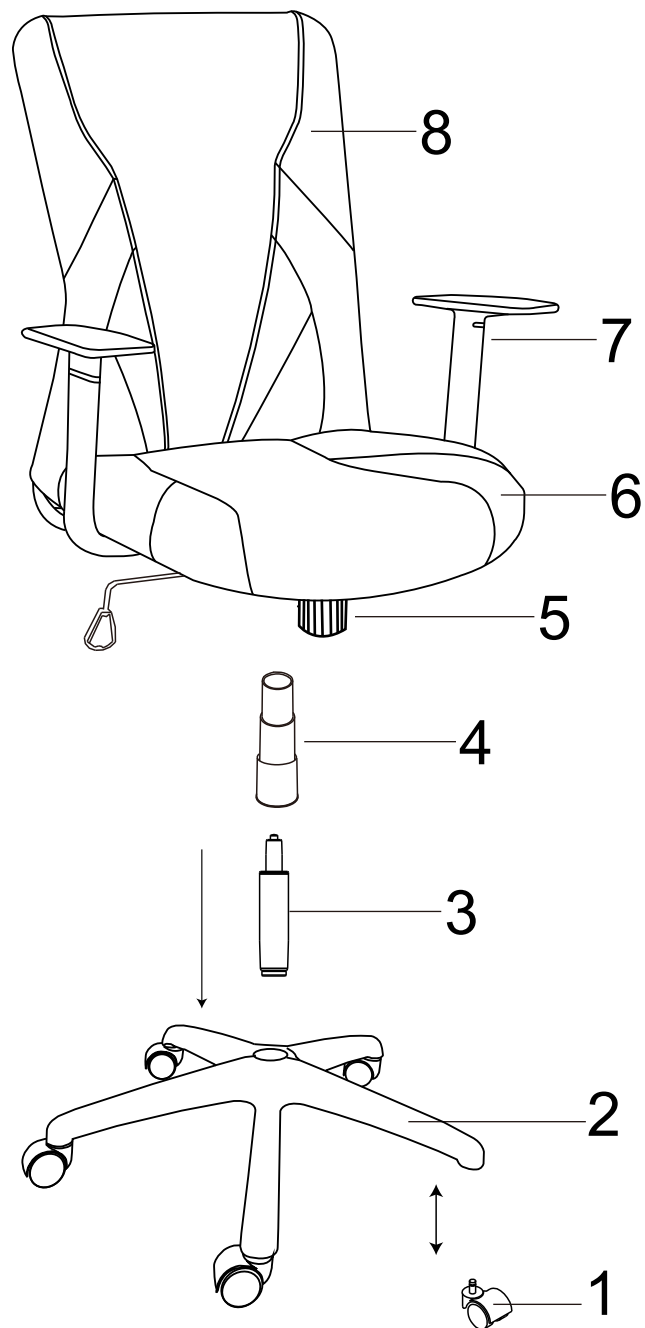











- D** Achtung: Arbeiten an- und Austausch der Gasdruckfeder nur durch eingewiesenes Fachpersonal
- GB** Caution: work on and exchange of the gas spring shall be done only by trained personnel
- HU** Figyelem, munka a gázteleszkópon és annak cseréje csak betanított szakszemélyzet által végezhető
- S** OBS! Arbete vid och utbyte av gasfjädern endast genom utbildad personal
- NL** Waarschuwing, werk aan- en vervangen van de gasdrukveer alleen door deskundig vakpersoneel te verrichten.
- LT** Dėmesio, atlikti darbus su dujinėmis spyruoklėmis bei jas pakeisti gali tik kvalifikuoti darbuotojai.
- RO** Atenție: lucrările la și înlocuirea arcului pe gaz se va face doar de către personal instruit.
- RU** Внимание: Работы и смена газонаполненного амортизатора могут быть выполнены только проинструктированным,
- PL** Uwaga, prace przy podnośniku pneumatycznym lub jego wymiana mogą być przeprowadzane wyłącznie przez przeszkolony personel.
- SRB** Pažnja: radove na ugradnji i zamjeni plinske pritisne opruge izvoditi samo sa stručnim osobljem
- HR** Pozor: radnje na ugradnju i zamjeni plinske tlačne opruge smije se izvoditi samo preko stručnog osoblja
- LV** "Uzmanību! Darbu ar gāzes piespiedējsperi un tāas nomaiņu drīkst veikt tikai instruetēts, kvalificēts personāls."
- EST** Tähelepanu, gaasrõhvedrude kallal tohib töötada ja neid vahetada ainult instrueeritud erialapersonal.
- SLK** Pozor, práce na plynovej vzpere a výmena plynovej vzpery iba prostredníctvom poučeného odborného personálu
- CZ** Pozor, práce na plynové pružině a její výměnu smí provádět pouze vyškolený odborný personál.
- BG** Внимание! Смяната на газовия амортизатор се извършва само от обучени специалисти.
- SLO** Pozor, kakršnakoli dela na plinskih vzmeteh in menjave lahko izvajajo samo izšolani strokovnjaki.
- IT** Attenzione: Lavori sulla molla a gas o la sua sostituzione solo da personale specializzato
- F** Attention : Travaux au ressort à gaz ou son échange seulement par personnel spécialisé
- ES** Cuidado: Trabajos en el amortiguador de gas o su cambio únicamente por personal especializado
- P** Atenção: Trabalhos na mola de pressão a gás ou sua substituição exclusivamente por pessoal Especializad
- TR** Dikkat: Gaz basıncını yayı değiştirilmesi ve üzerinde çalışmaları sadece bilgilendirilmiş uzman personel tarafından yapılabilir.

- D** nur für den privaten Gebrauch
- GB** Only for domestic use
- HU** csak magánhasználatra
- S** endast för privat bruk
- NL** uitsluitend voor privégebruik
- LT** tik asmeniniam naudojimui
- RO** doar pentru uz privat
- PL** wyłącznie do użytku prywatnego
- SRB** Samo za privatnu upotrebu
- HR** Samo za privatnu uporabu
- LV** tikai privātai lietošanai
- EST** ainult erakasutuseks
- SLK** iba na súkromné použitie
- CZ** pouze pro soukromé používání
- BG** само за лично ползване
- SLO** samo za zasebno uporabo
- IT** Solo per l'uso privato
- F** Seulement pour l'utilisation domestique
- ES** únicamente a uso personal
- P** Apenas para uso privado
- TR** sadece özel kullanım için
- D** gebremste Rollen/ Teppichrollen
- GB** pressure casters/\_carpet casters
- HU** fékezett hengerek/\_szőnyegtekercsek
- S** bromsade hjul/\_hjul för mjuka golv
- NL** geremde wielen/\_tapijrtrollen
- LT** stabdantys ratukai/\_kiliminei dangai skirti ratukai
- RO** role-roți cu frână/\_Role pentru pardoseală moale
- RU** рулон коврового напольного покрытия
- PL** kółka z hamulcem/\_kółka twarde do nawierzchni miękkich (dywan)
- SRE** Valjci na kočenje/\_Rolne za tepihe
- HR** Kočni valjci/\_Svitci za tepihe
- LV** nofiksētie ritenīši/\_paklāju rullji
- EST** pidurdatud rullid/\_Vaibarattad
- SLK** brzdené kolieska/\_Kolieska na mäkké podlahy
- CZ** brzděná kolečka/ Kolečka na koberce
- BG** колелца със спирачки/ Колелца за килими
- SLO** kolesa z zavorami/ Kolesa za preproge
- IT** Rulli frenati/ Rotoli di tappeto
- F** Roulettes freinées/ Rouleaux de moquette
- ES** Ruedas frenadas/ Rollos de tapiz
- P** Rodas travadas/ Rolos de carpete
- TR** frenli makaralar/ Hali Taban Rulosu

