

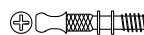



A 
EURO SHTRAF X 15

B 
Ø 4 x 20 /x 15

C 
Ø 8 x 30 /x 24

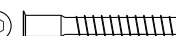
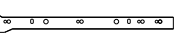
D 
M 8 x 70 /x 11

E 
x 2 aus.

F 
Ø 4 x 35 /x 44

G 
EURO SHTRAF X 14

H 
Ø 4 x 16 /x 36

I 
glue /x 1

J 
x 6

K 
x 2

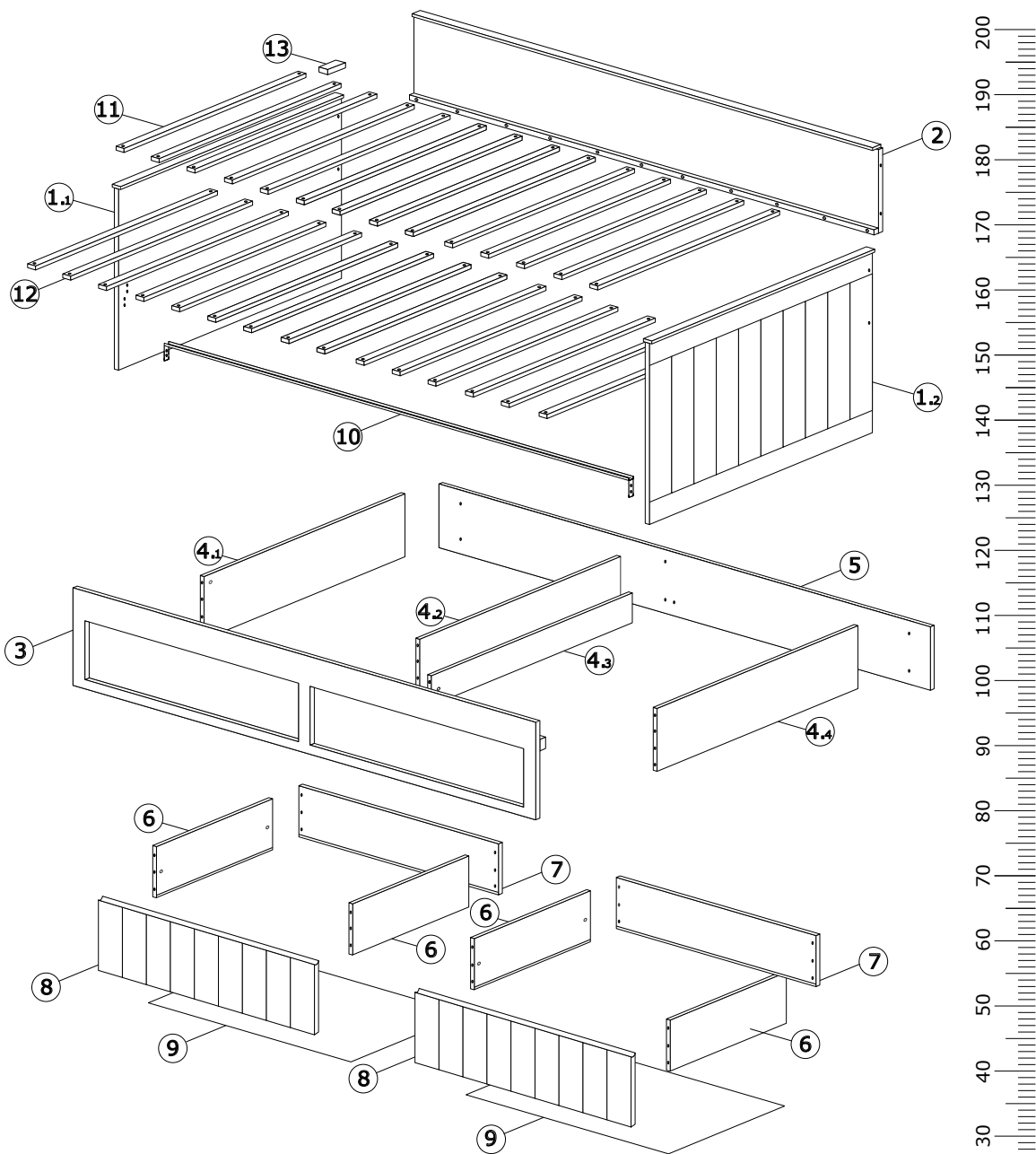

Stückliste / Bill of Materials / Detail visserie

N°	QTY.	Dimensions / mm	Box*
1	2	970 x 798 x 18 (+20)	1/4
2	1	2000 x 533 x 18 (+25, +10)	2/4
3	1	1993 x 390 x 18 (+25)	2/4
4.1	1	882 x 273 x 18	3/4
4.2	1	882 x 273 x 18	3/4
4.3	1	882 x 100 x 18	3/4
4.4	1	882 x 273 x 18	3/4
5	1	1994 x 273 x 18	3/4

N°	QTY.	Dimensions / mm	Box*
6	4	500 x 150 x 18	3/4
7	2	858 x 150 x 18	3/4
8	2	934 x 225 x 18	2/4
9	2	877 x 502 x 3	1/4
10	1	2000 x 20 x 10	2/4
11	14	925 x 48 x 18	4/4**
12	15	900 x 48 x 18	4/4**
13	1	90 x 48 x 18	4/4**

* Welches Teil ist in welcher box / Which part is in which box / Répartition des pièces par boîte
 ** Zusätzlicher Satz optional / Additional set optional / Jeu supplémentaire en option

(D) ACHTUNG bei einer Beanstandung !!
 Um eine zügige Beanstandungsabwicklung zu gewährleisten, bitte bei Beschlägen den Buchstaben und die Menge angeben, Beispiel: A M6x95
 bei Möbelteilen die Zahl angeben
 Beispiel: 1 1960x160x20

(GB) if you have a COMPLAINT !!
 in order to enable us to deal with any complaints quickly, in the case fittings please state the letter and the quantity, Example: A M6x95
 For furniture items please state the number
 Example: 1 1960x160x20

(NL) OPGELET bij een klacht !!
 Om een vlotte klachtenafwijking te waarborgen, bij beslag de letters, het codenumber, en het aai, bvb: A M6x95
 bij meubeldelenhet kengetal aangeven
 bvb: 1 1960x160x20

(E) ATTENTION en cas de réclamation !!
 Pour assurer un traitement rapide des réclamation, veuillez indiquer, pour les ferrures, la lettre, le n, Exemple: A M6x95
 Pour les parties de meubles indiquer le nombre
 Exemple: 1 1960x160x20