

2021-12-01

CABRIO V

2100+37+64+19+90-8242+64+89+90

8241+64+89+90-2300+37+64+19+90

2100+37+64+19+90-5010+64-1073+64+37+88

1071+64+37+88-5010+64-2300+37+64+19+90

8241+64+89+90-2000+19+64+37-5010+64-1073+64+37+88

1071+64+37+88-5010+64-2000+19+64+37-8242+64+89+90

6030

**D** MONTAGEANLEITUNG  
BEDIENUNGSANLEITUNG

**NL** HANDLEIDING VOOR DE MONTAGE  
GEBRUIKSAANWIJZING

**TR** MONTAJ TALIMATI  
KULLANIM KLAVUZU

**RO** INSTRUCȚIUNI DE INSTALARE  
INSTRUCȚIUNI DE UTILIZARE

**FR** NOTICE DE MONTAGE  
MANUEL 'INSTRUCTIONS

**HU** KÖZGYŰLÉS UTASÍTÁSOK  
KEZELÉSI UTASÍTÁS

**SI** NAVODILA ZA MONTAŽO  
NAVODILA ZA UPORABO

**ES** INSTRUCCIONES DE MONTAJE  
MANUAL DEL USUARIO

**GB** ASSEMBLY INSTRUCTIONS  
INSTRUCTION MANUAL

**PL** INSTRUKCJA MONTAŻU  
INSTRUKCJA OBSŁUGI

**RU** ИНСТРУКЦИЯ ПО МОНТАЖУ  
ИНСТРУКЦИЯ ПО ЭКСПЛУАТАЦИИ

**IT** ISTRUZIONI DI MONTAGGIO  
MANUALE DI ISTRUZIONI

**SK** MONTÁŽNY NÁVOD  
NÁVOD NA POUŽITIE

**CZ** MONTÁŽNÍ NÁVOD  
NÁVOD K POUŽITÍ

**PT** INSTRUÇÕES DE MONTAGEM  
MANUAL DO USUÁRIO









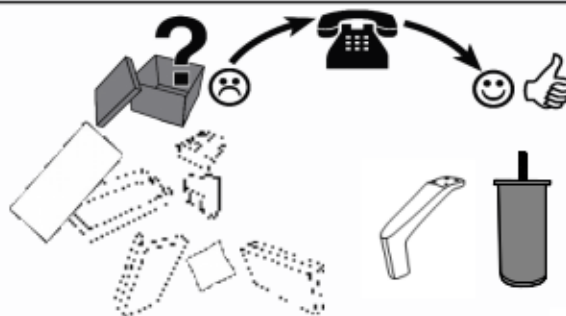

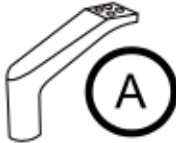

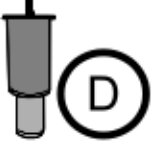
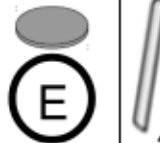





**HR** UPUTE ZA MONTAŽU  
UPUTE ZA UPOTREBU

Name · Naam · Nazwa · İsim · Название · Nume · Nome · Názov · Nazov  
 Název · Neve

CabrioV

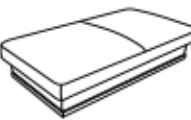
Тур · Туре · Тір · Тип · Тіро · Тірус



		 (A)	 M6 *25 (B)	 (C)	 (D)	 (E)	 (F) 4L
 (G)		x2	x8	/	x2	x4	
 (G')		x2	x8	/	x2	x4	
 (H)		x3	x12	x1	x2	x6	
 (K)		x1	x4	x3	/	x4	x1
 (L)		x2	x8	/	x1	x3	
 (N)		x4	x16	/	/	x4	
 (O)		/	/	/	/	/	
 (O')		/	/	/	/	/	

Name · Naam · Nazwa · İsim · Название · Nume · Nome · Názov · Názov ·  
 Název · Neve

**Cabrio**

Typ · Type · Tip · Тип · Tipo · Típus

☎ 2100+37+64+19+90-8242+64+89+90, 8241+64+89+90-2300+37+64+19+90

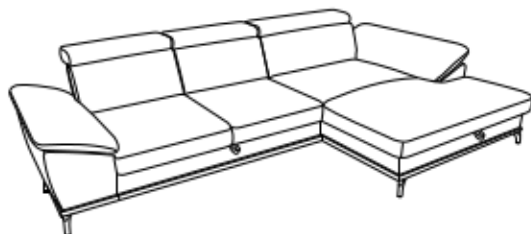
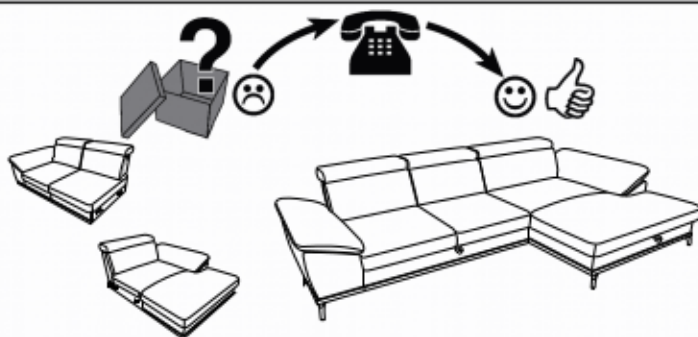

**G / G'**



**I / I'**



**H**

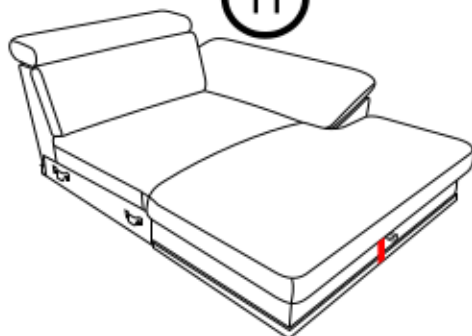

**J**

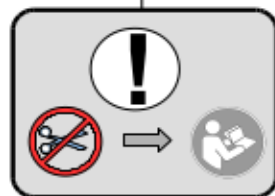

**N**

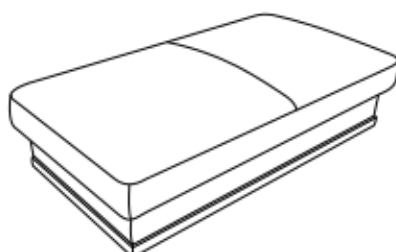

Name · Naam · Nazwa · İsim · Название · Nume · Nome · Název · Názov ·  
 Název · Neve

# Cabrio

Typ · Type · Tip · Тип · Tipo · Típus

2100+37+64+19+90-5010+64-1073+37+64+88,  
 1071+37+64+88-5010+64-2300+37+64+19+90

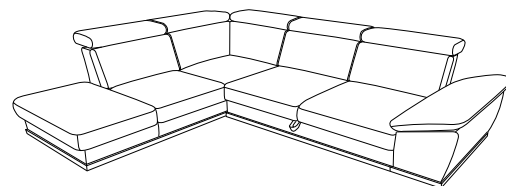
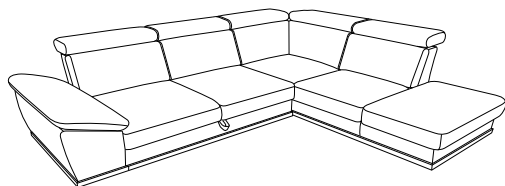
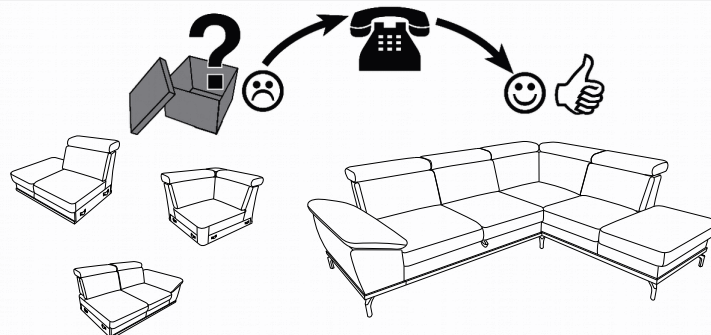
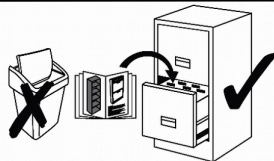

ⓐ / ⓐ'

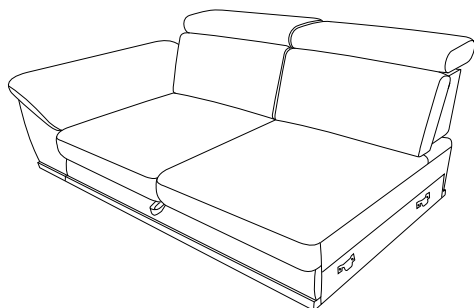

ⓑ / ⓑ'

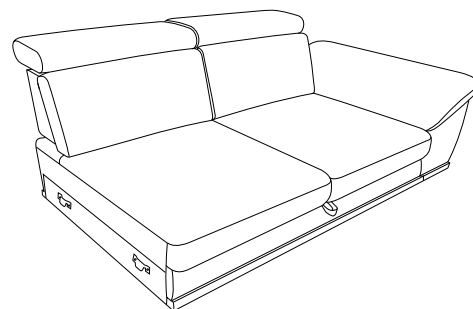

ⓒ

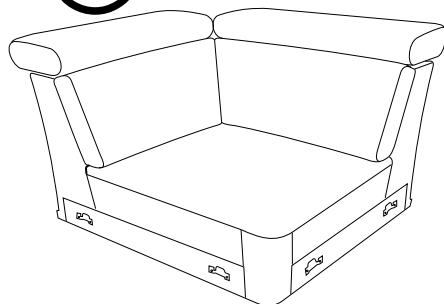

ⓒ

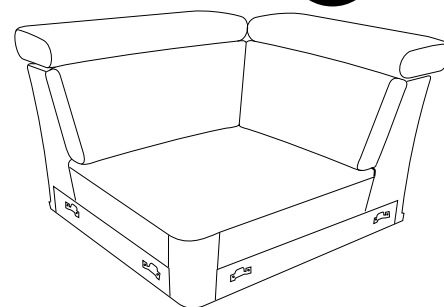

ⓓ

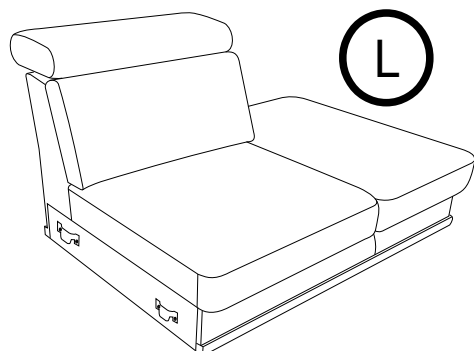

ⓓ

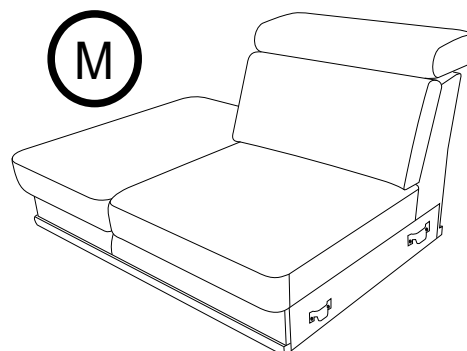

Name · Naam · Nazwa · İsim · Название · Nume · Nome · Název · Názov ·  
 Název · Neve

# Cabrio

Typ · Type · Tip · Тип · Tipo · Típus

8241+64+89+90-2500+19+64+37-5010+64-1073+64+37+88,  
 1071+37+64+88-5010+64-2500+19+64+37-8242+64+89+90

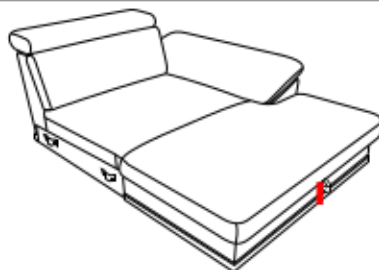
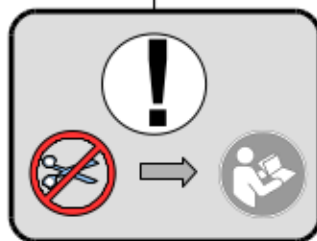
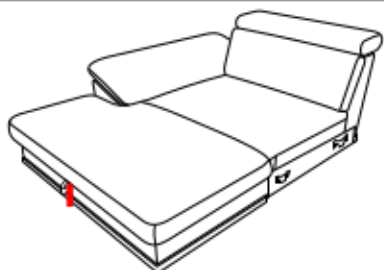
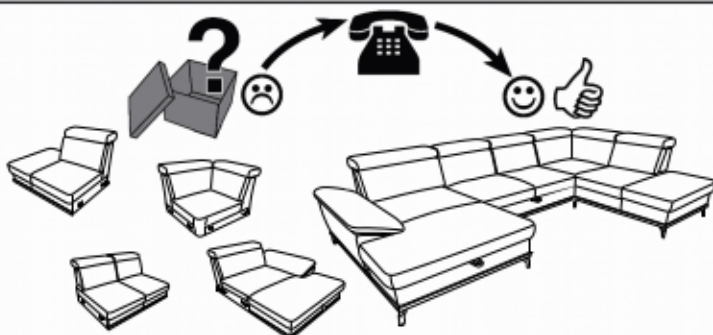

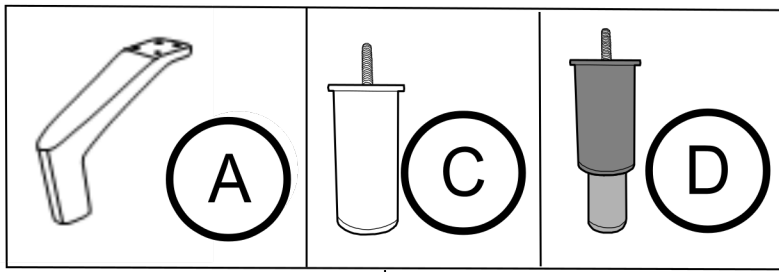

(G)

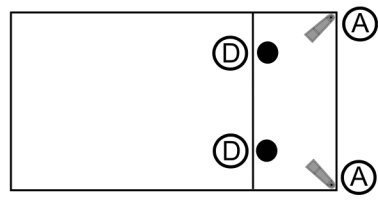
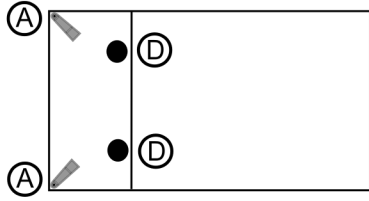

(I)

(G')

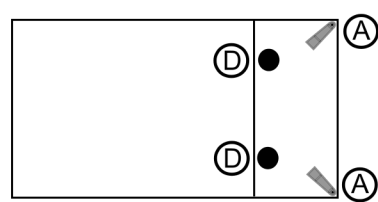
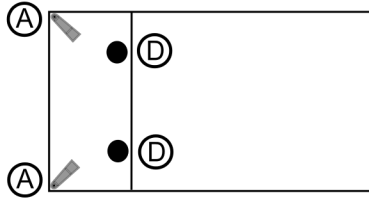

(I')

(H)

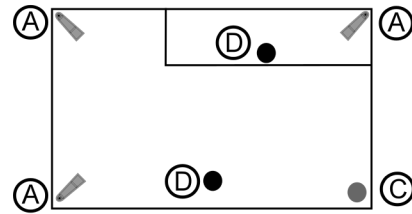
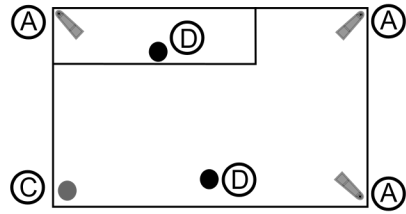

(J)

(K)

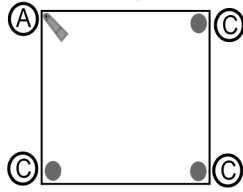

(L)

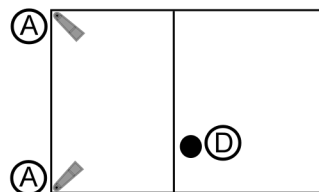
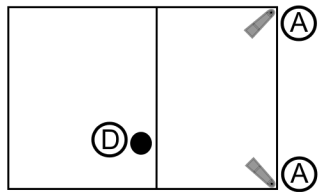

(M)

(N)



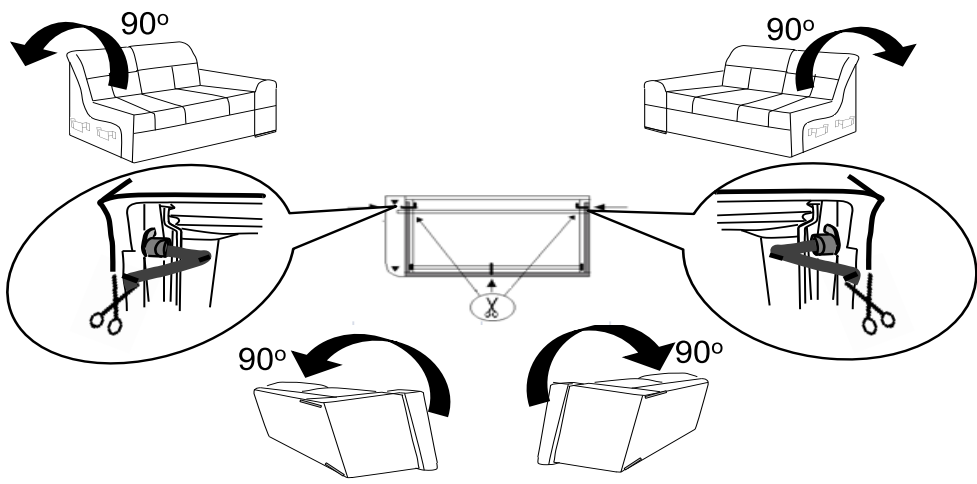
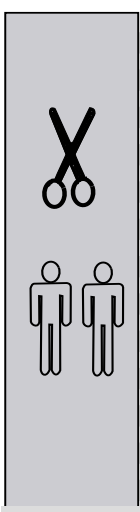

1

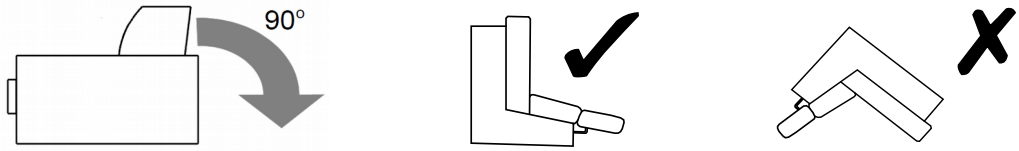

2

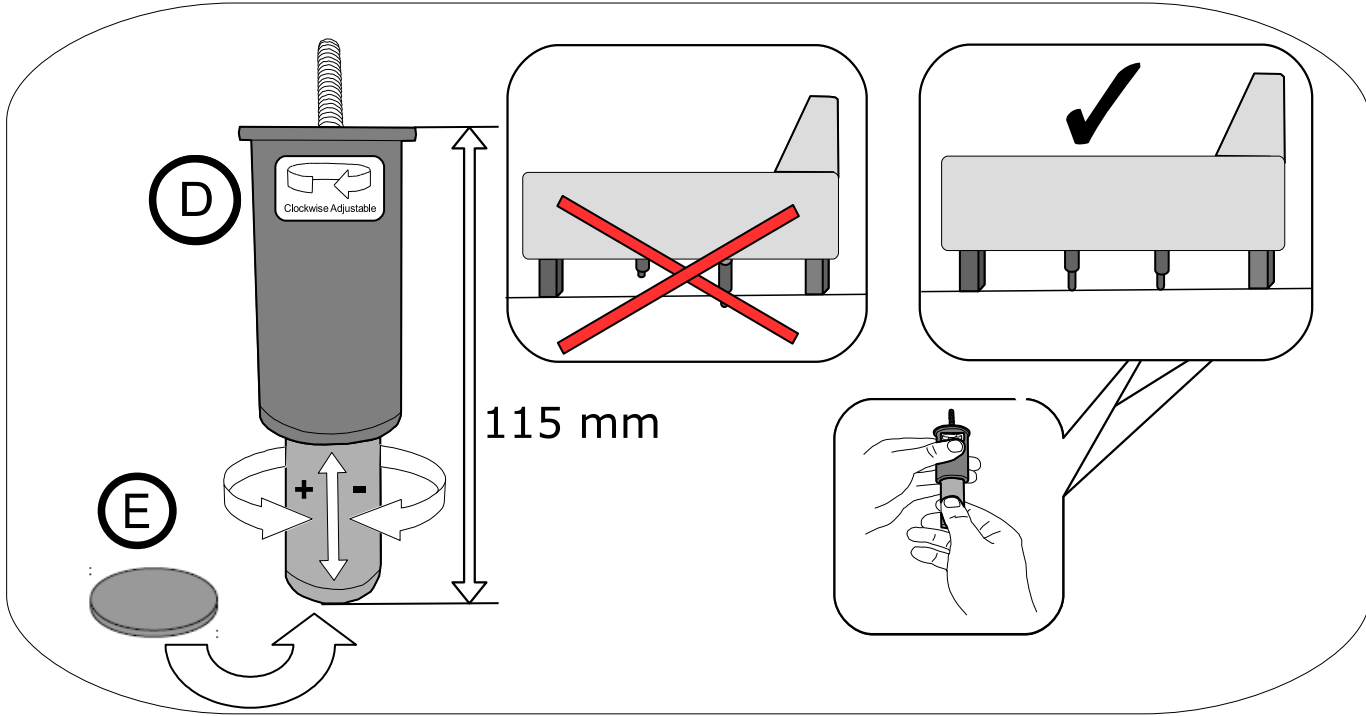
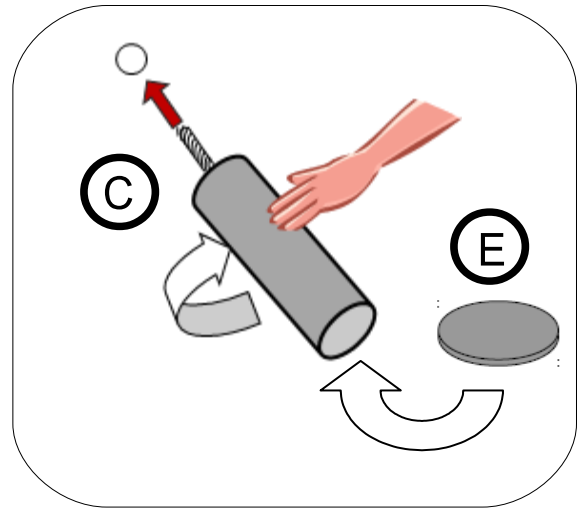
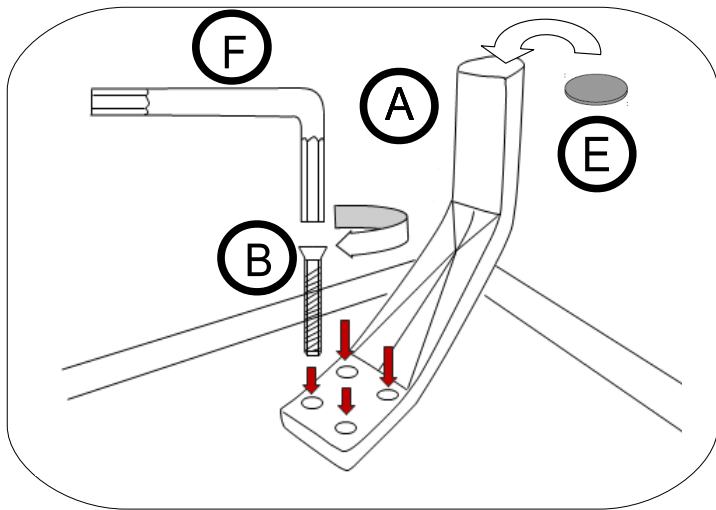

3

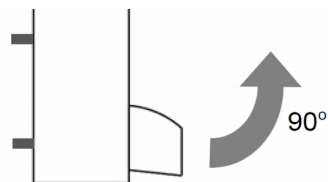

1



2

G / G'

H

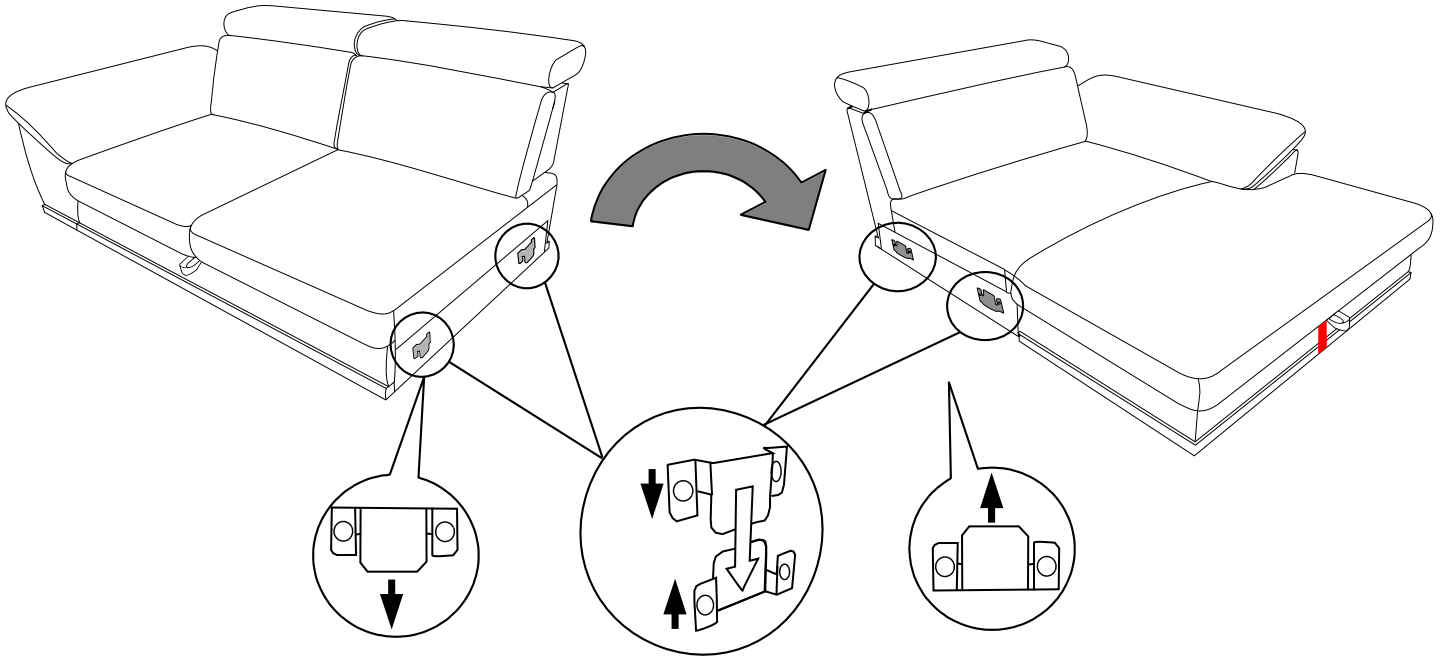

3



4

J

I / I'

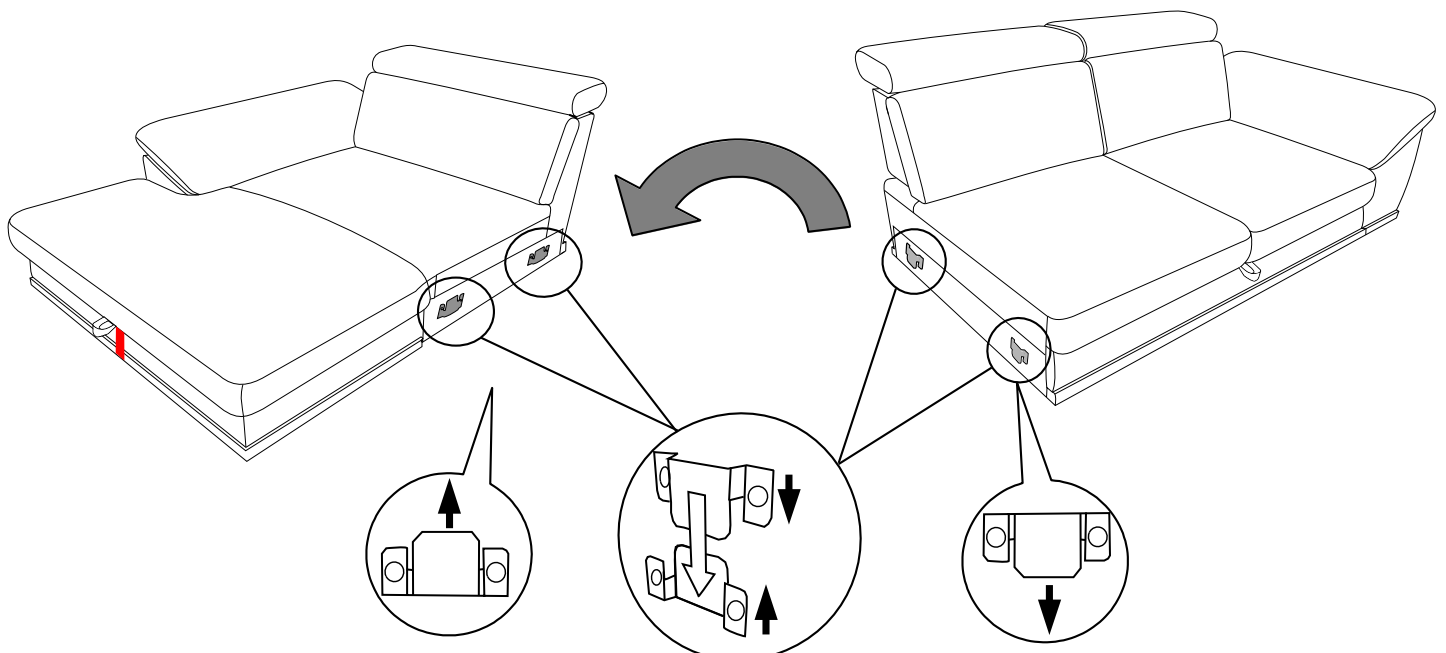



5

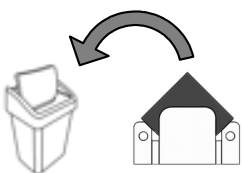

6

(G) / (G')

(K)

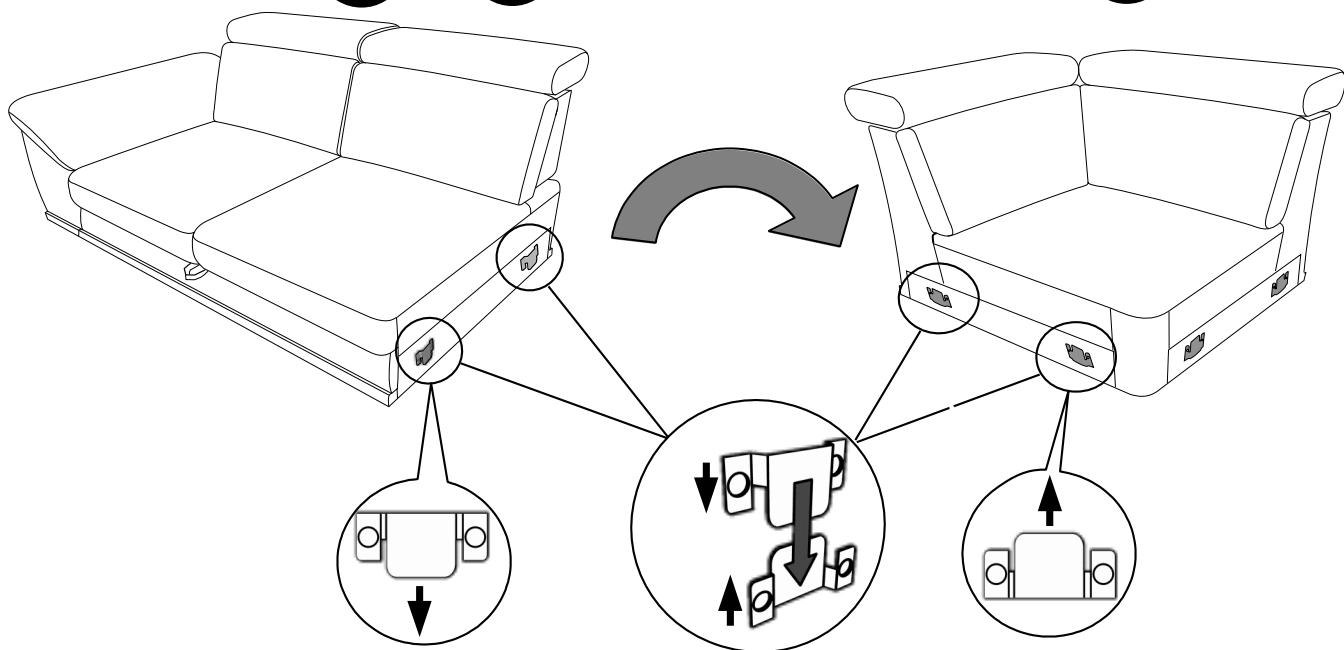

7

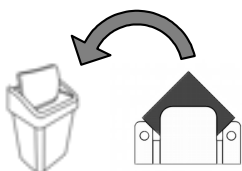

8

(K)

(L)

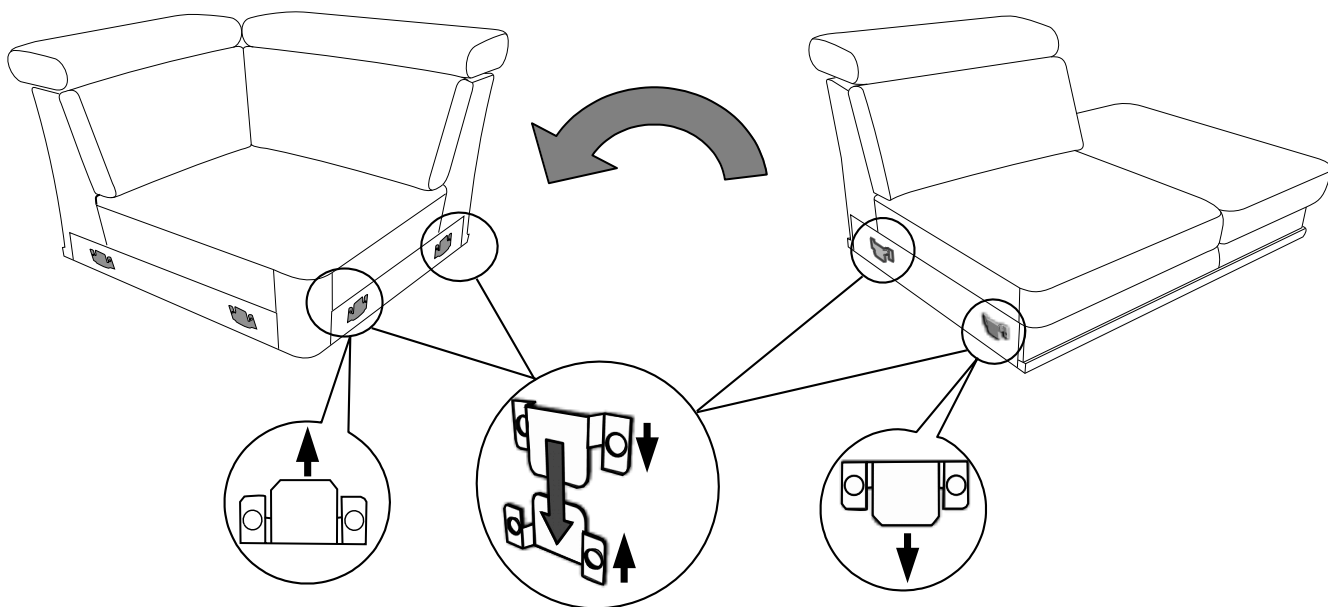

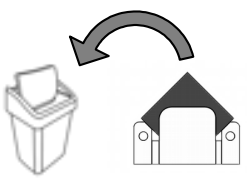

(M)

(K)

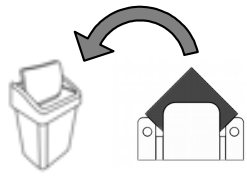
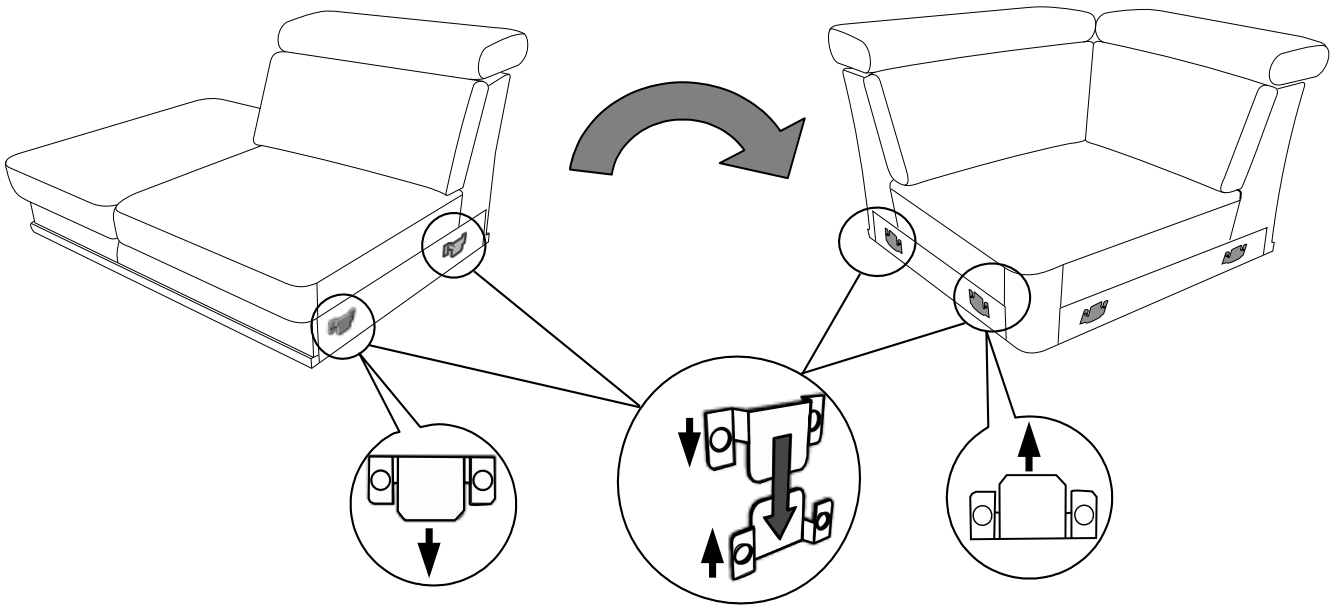

(K)

(I)/(I')

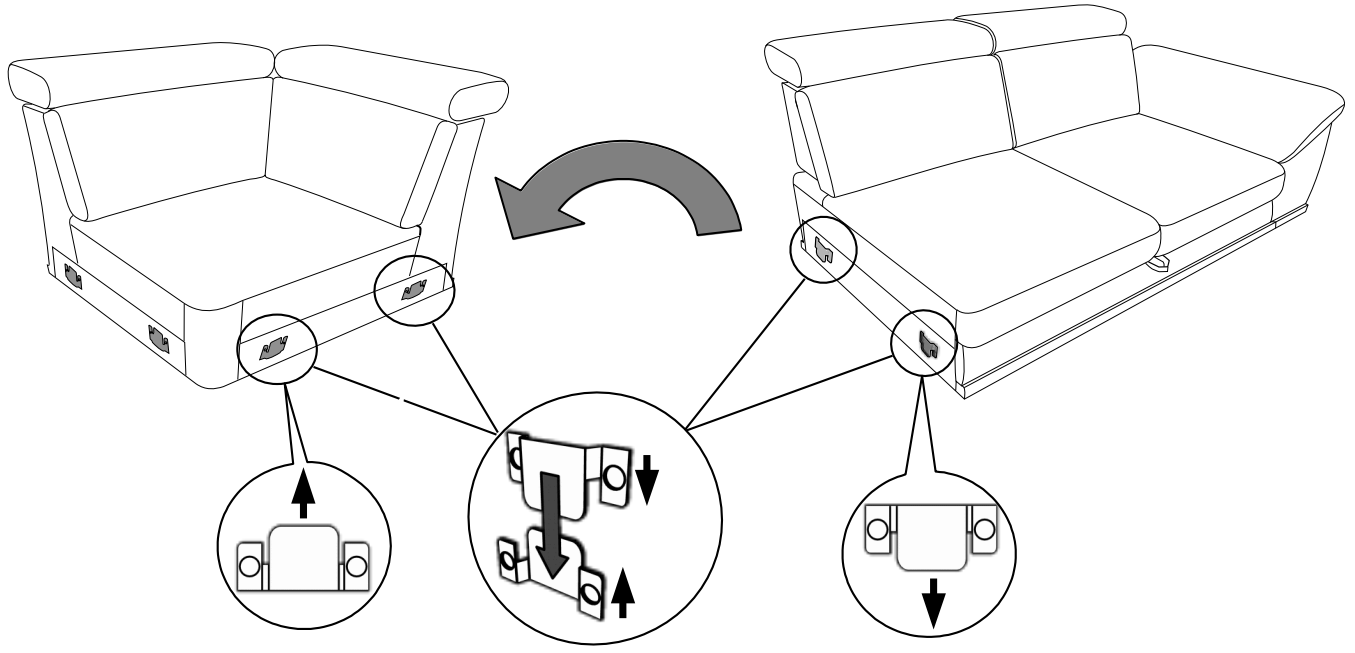

13



14

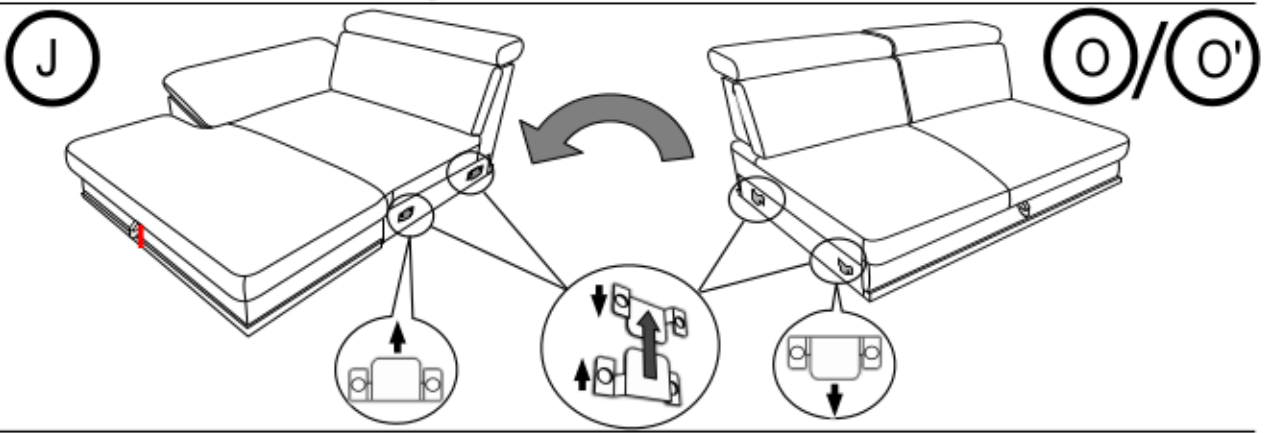

15



16

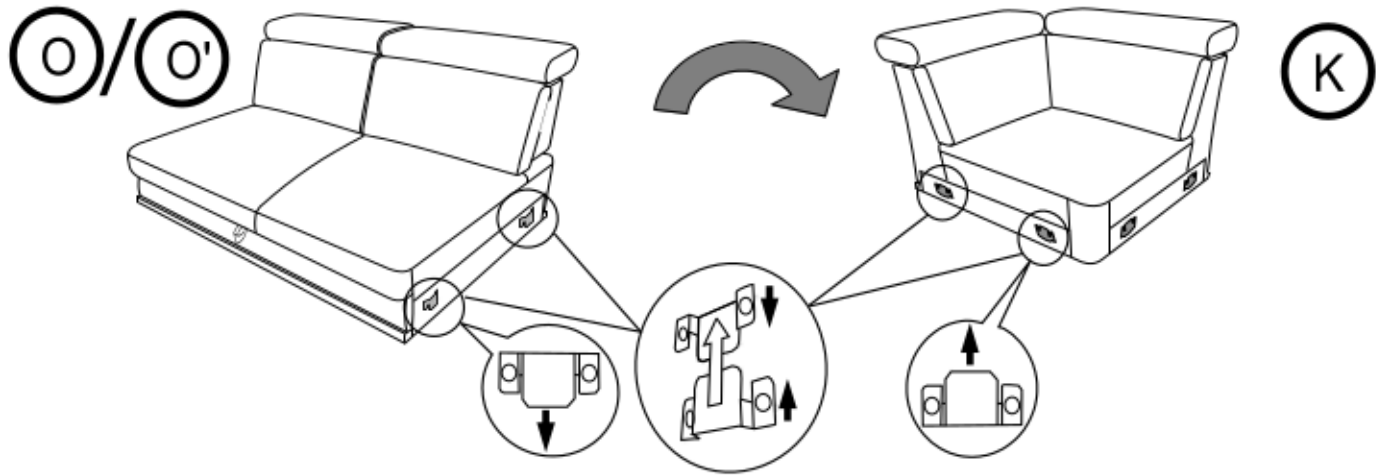

17

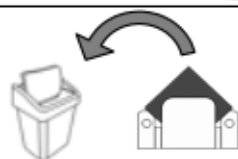

18

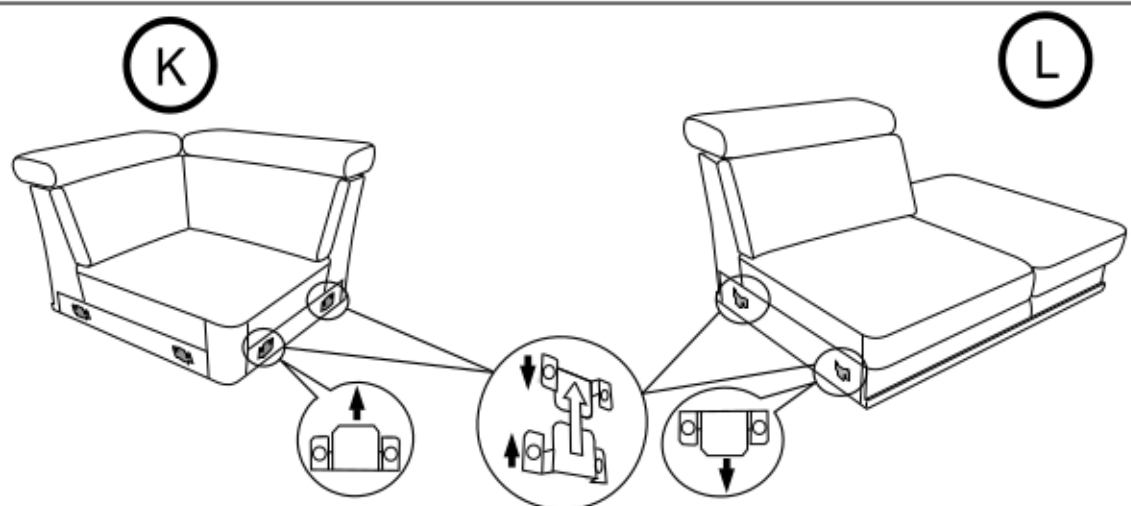

19



20

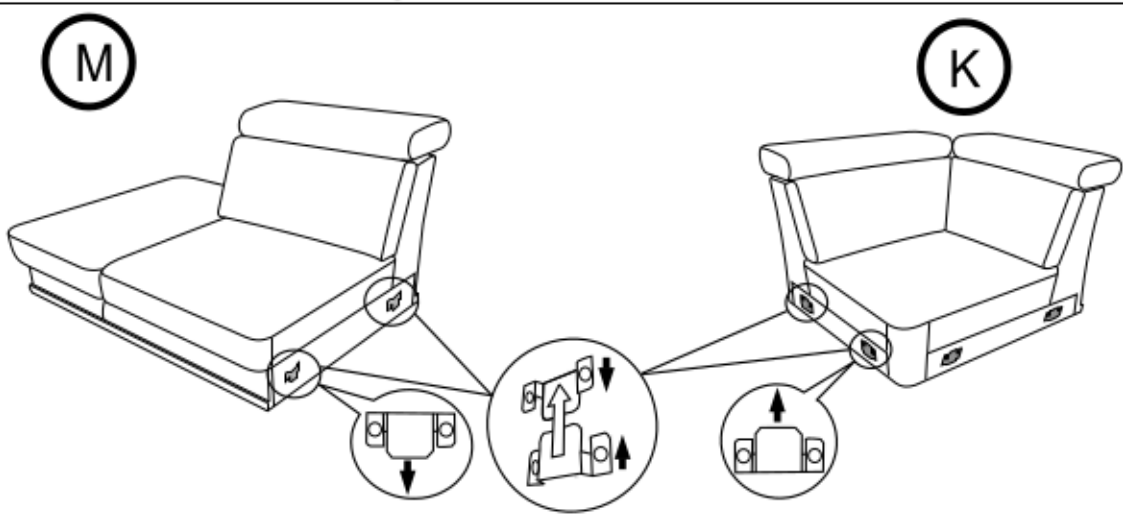

21

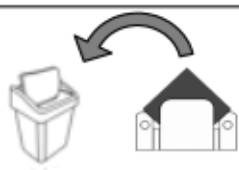

22

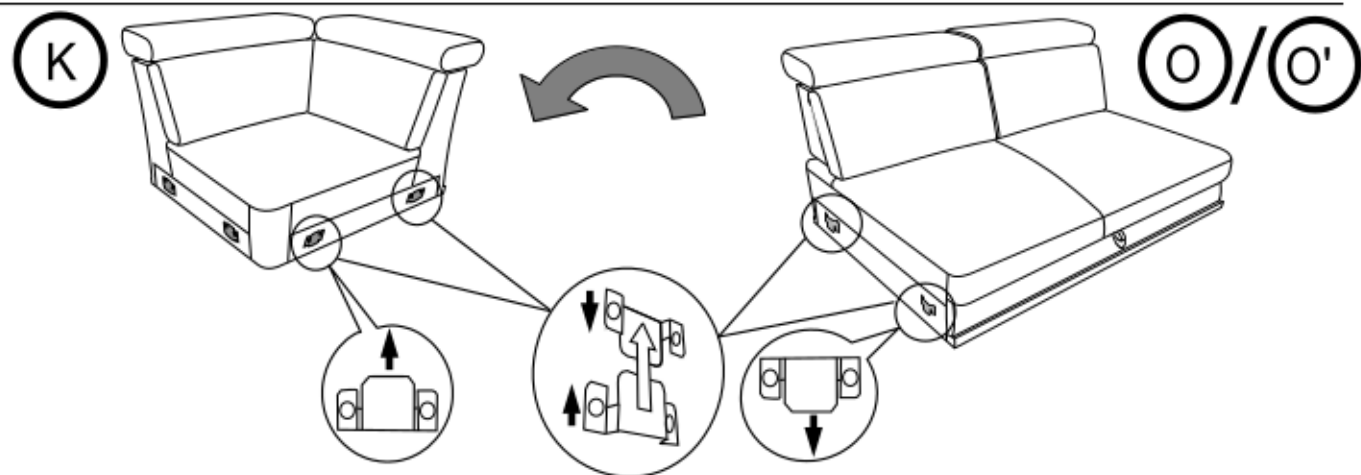

23



24

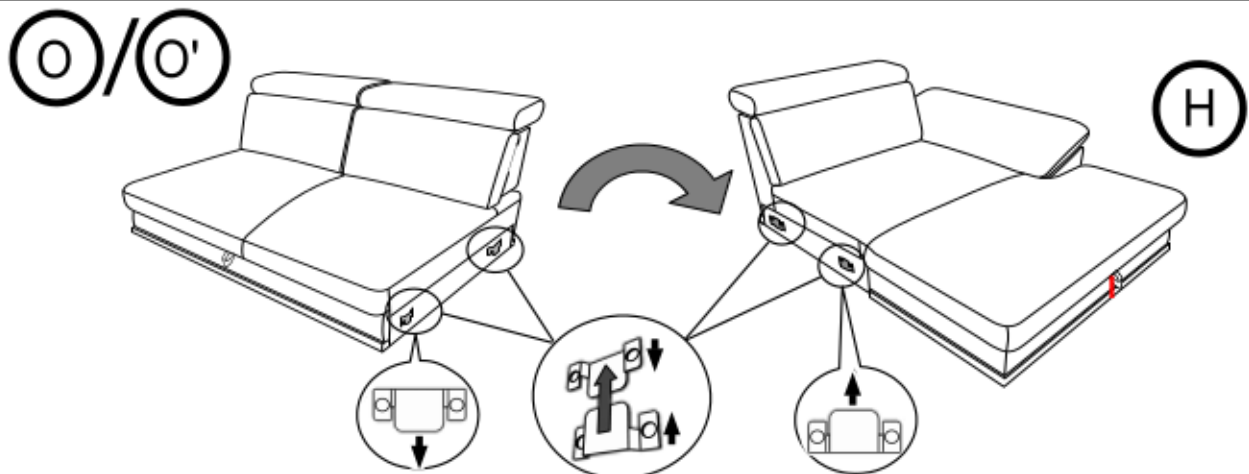

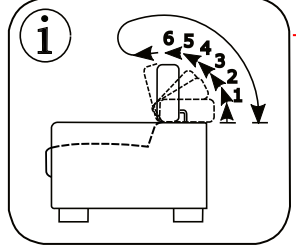

x6

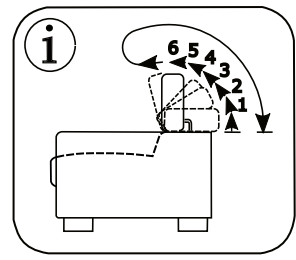
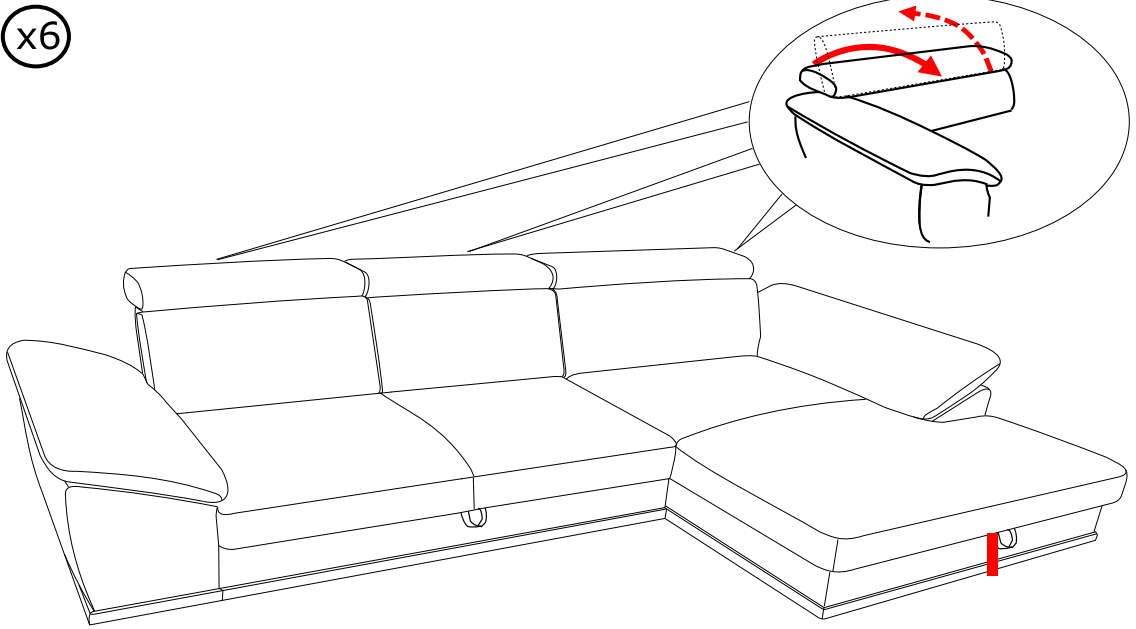

x6

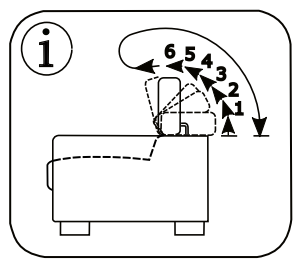
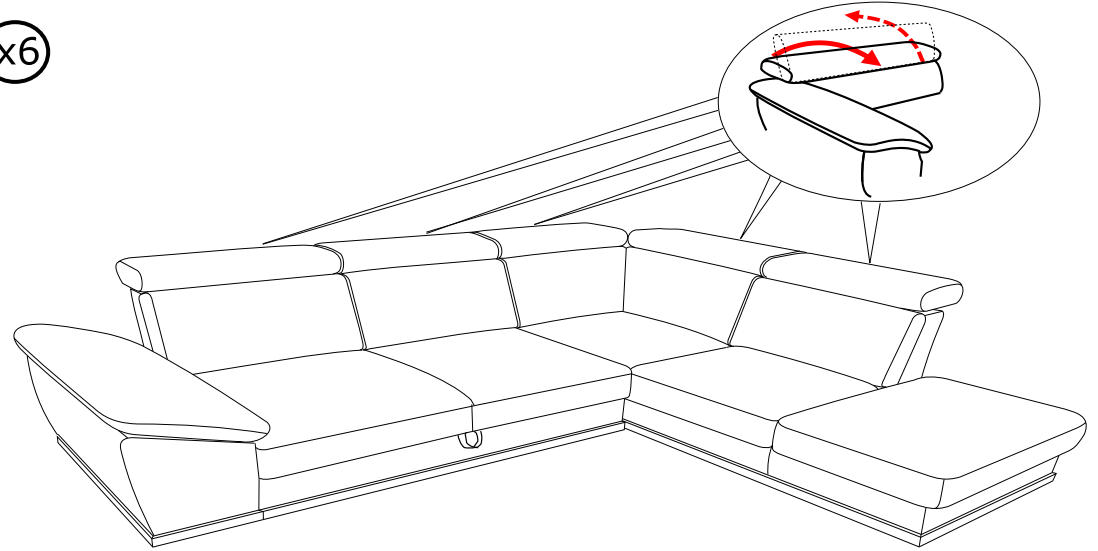

x6

