

Corona



D Montageanleitung

GB Assembly instructions

FR Notice de montage

NL Handleiding voor de montage

CZ Montážní návod

IT Istruzioni di montaggio

RO Instrucțiuni de montaj

RU инструкция по сборке

PL Instrukcja montażu

SK Návod na montáž

HU Szerelési útmutató

TR Montaj talimati

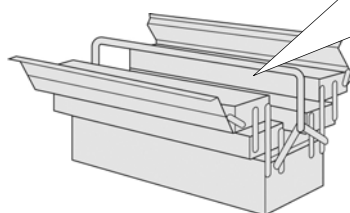
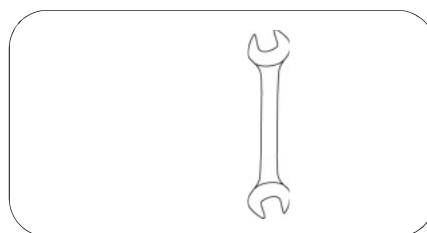
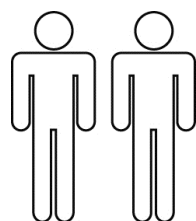
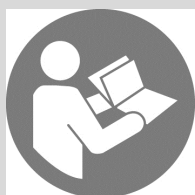

0
10
20
30
40
50
60
70
80
90
100
110
120
130
140
150
160
170
180
190
200

Service • Assistenza • Dienstverlening • Serwis Servis • Szerviz • Сервисная служба	
Name • Nom • Nome • Naam Nazwa • Jméno • Názov • Név Denumire • İsim • Название	Corona DB
Nr. • No. • N° • Номер • Č • Sz	SH45
Typ • Type • Tip • Típus • Tipo Тип	OHNE

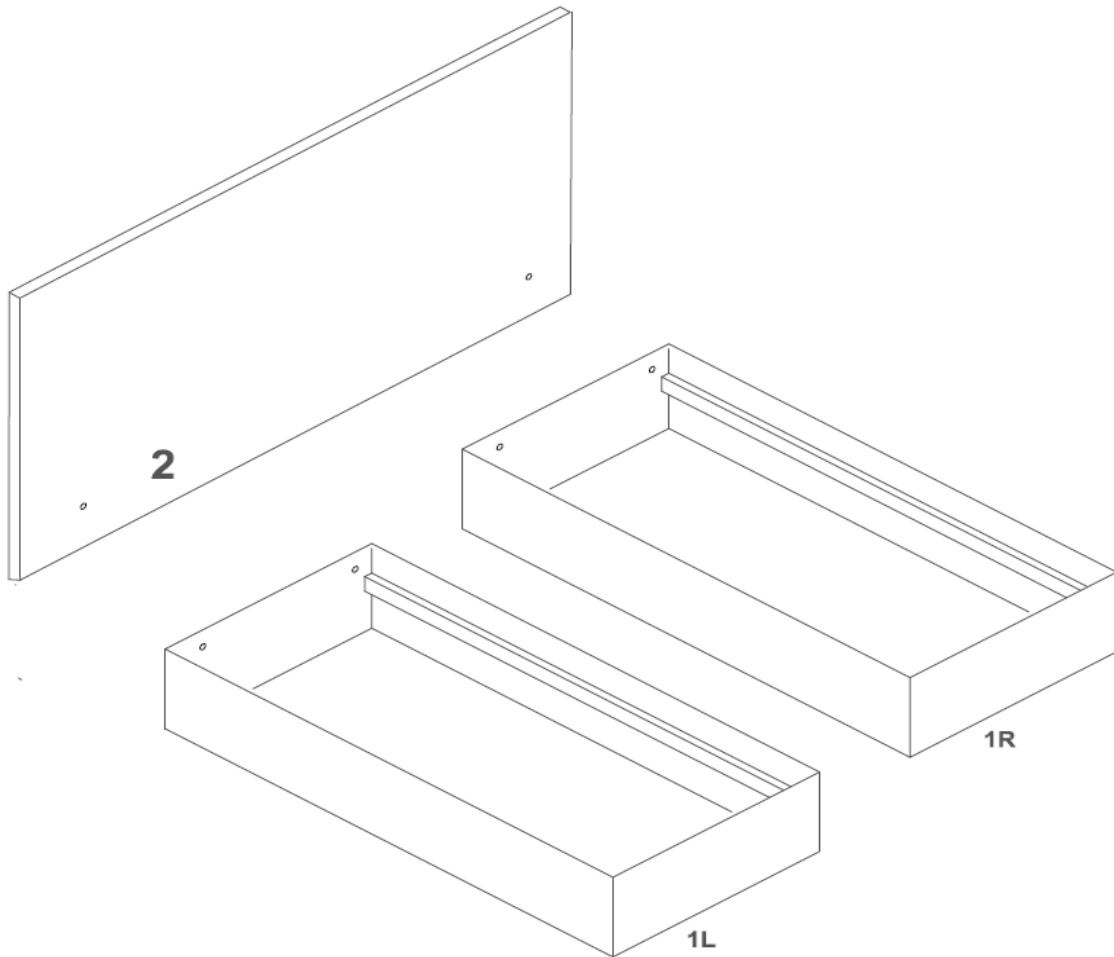

A	B	C	D	E	F	G	H
4x	1x 6x45	1x M6	1x M6	1x M6	2x 8x70	2x M8	2x M8



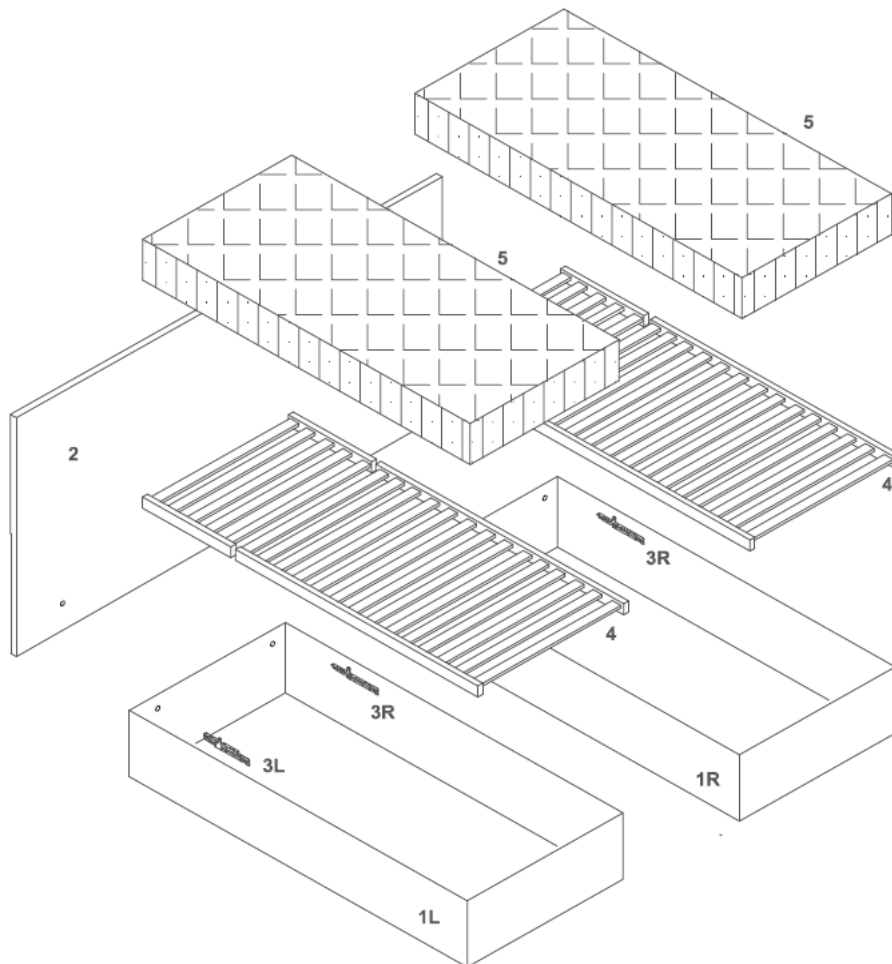

0
10
20
30
40
50
60
70
80
90
100
110
120
130
140
150
160
170
180
190
200

Service • Assistenza • Dienstverlening • Serwis Servis • Szerviz • Сервисная служба	
Name • Nom • Nome • Naam Nazwa • Jméno • Názov • Név Denumire • İsim • Название	Corona DB
Nr. • No. • N° • Номер • Č • Sz	SH45
Typ • Type • Tip • Típus • Тіро Тип	LARO



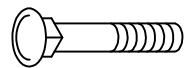

A	B	C	D	E	F	G	H
4x	1x 6x45	1x M6	1x M6	1x M6	2x 8x70	2x M8	2x M8

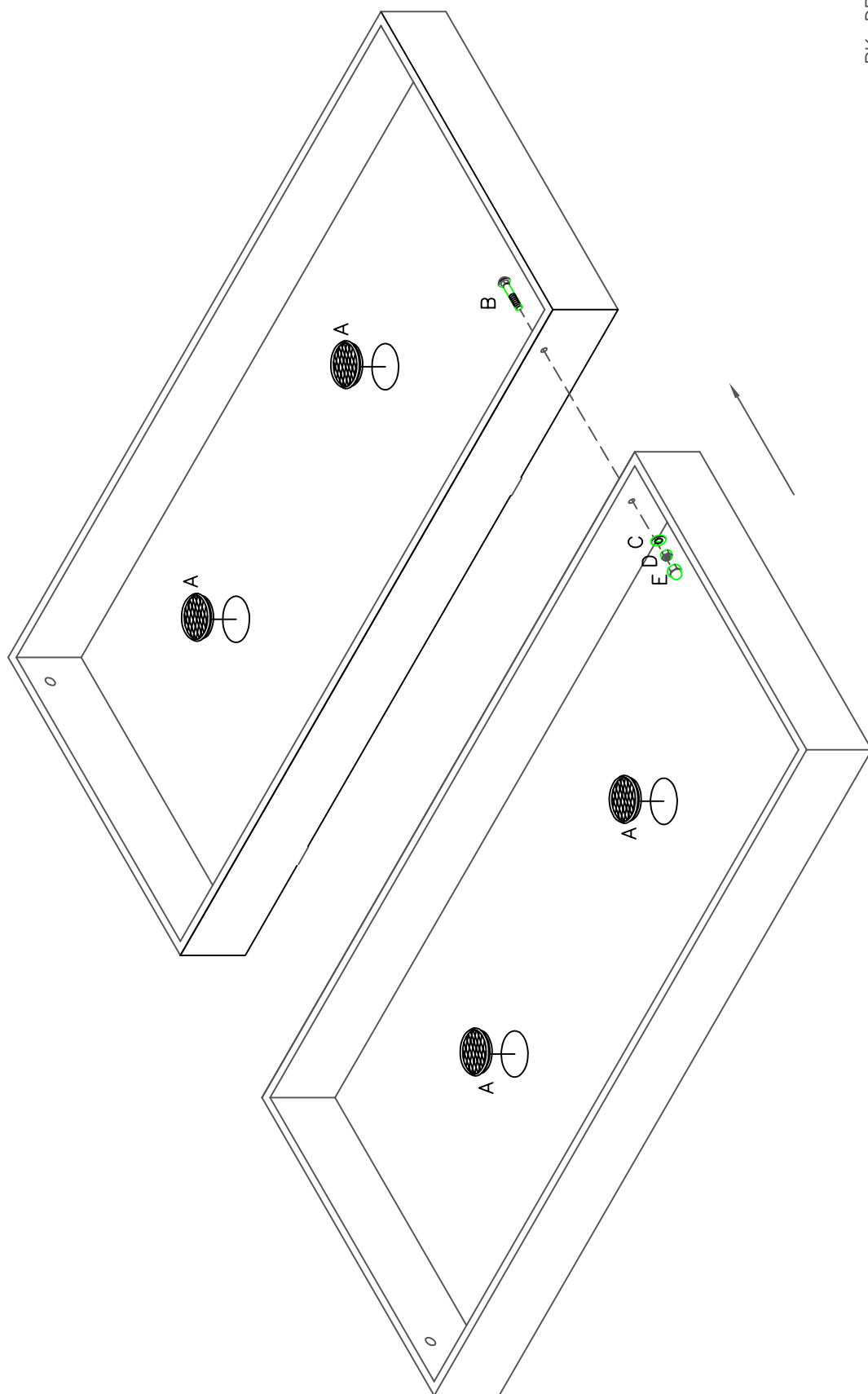

A		4x
B		1x 6x45
C		1x M6
D		1x M6
E		1x M6





<p>F</p>  <p>2x 8x70</p>	<p>H</p>  <p>2x M8</p>	<p>Achtung! Schrauben nicht überdrehen</p> <p>FR Attention! Ne serrez pas trop</p> <p>CZ Dávejte pozor! Nepřetahujte</p> <p>RO Ai Grija! Nu strângeți</p> <p>PL Uwaga! Nie dokręcać zbyt mocno</p> <p>HU Vigyázz! Ne húzza túl</p>	<p>GB Watch Out! Do not over tighten</p> <p>NL Let Op! Niet te vast</p> <p>IT Attenzione! Non stringere</p> <p>RU Осторожно! Не затягивайте</p> <p>SK Dávaj Pozor! Nepretahujte</p> <p>TR Dikkat! Üzerinde sıkmayın</p>
	<p>G</p>  <p>2x M8</p>		

