

F 551 Montageanleitung 6571 Datum 15.08.2019

D Montageanleitung

GB Assembly instructions

FR Notice de montage

IT Istruzioni di montaggio

NL Handleiding voor de montage

PL Instrukcja montażu

CZ Montážní návod

SK Návod na montáž



HU Szerelési útmutató

RO Instrucțiuni de montaj

TR Montaj talimatı

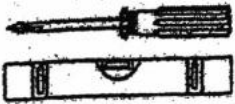
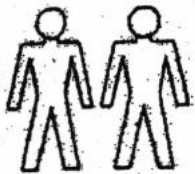
RU Инструкция по монтажу

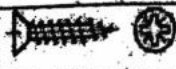
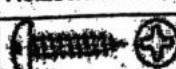

	4 x 3,5 x 16
Holzschraube	
	4 x 3,5 x 16
Blechschaube	
	4 x 60 mm

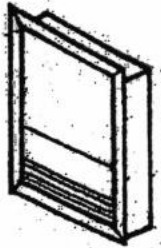
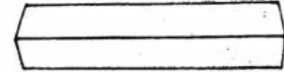
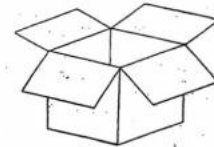
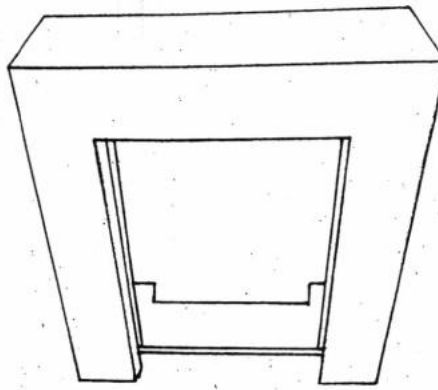

1

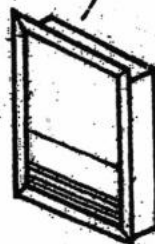
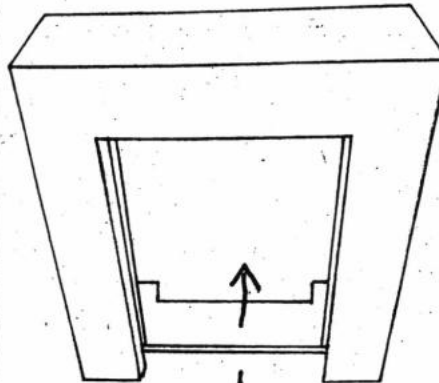

2

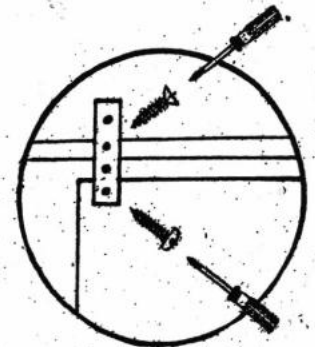
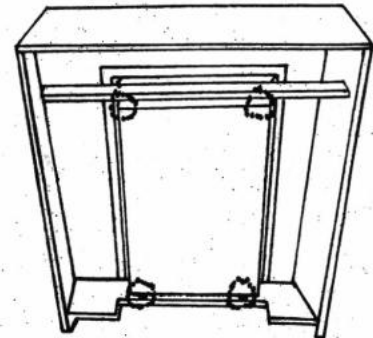

3

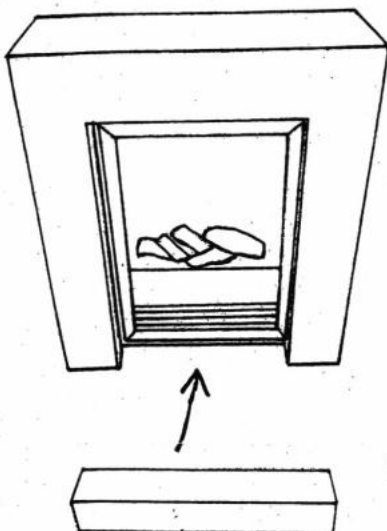

4

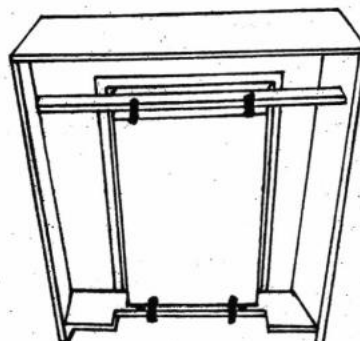

5

