

- | | |
|----------------------------------|-------------------------------|
| (D) AUFBAUANLEITUNG | (GB) ASSEMBLY INSTRUCTIONS |
| (NL) HANDLEIDING VOOR DE MONTAGE | (PL) INSTRUKCJA MONTAŻU |
| (TR) MONTAJ TALIMATI | (RU) Инструкция по монтажу |
| (RO) INSTRUCTIUNI DE ASAMBLARE | (I) PROCEDURA DI ASSEMBLAGGIO |
| (F) INSTRUCTION D'ASSEMBLAGE | (SK) POKYNY K MONTÁŽI |
| (CZ) POKYNY K MONTÁŽI | (HU) KÖZGYŰLÉS UTASÍTÁSOK |
| (BG) ИНСТРУКЦИИ ЗА МОНТАЖ | (SLD) ASSEMBLY INSTRUCTIONS |
| (HR) NAPUTCI ZA MONTAŽU | (S) MONTERINGSANVISNING |
| (E) INSTRUCCIONES DE MONTAJE | (LT) DIEGIMO INSTRUKCIJOS |

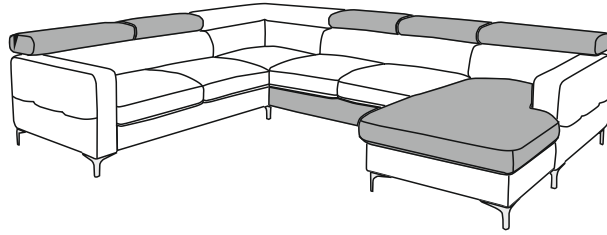

**„SAMMY”
2-RE-2F-REC/ BK**



1/2

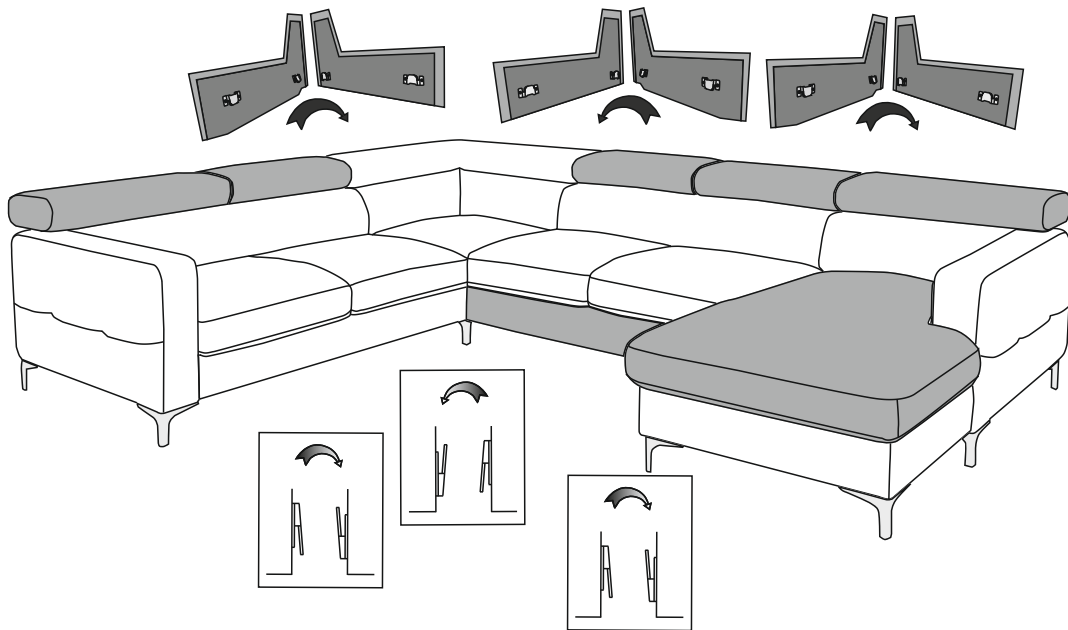
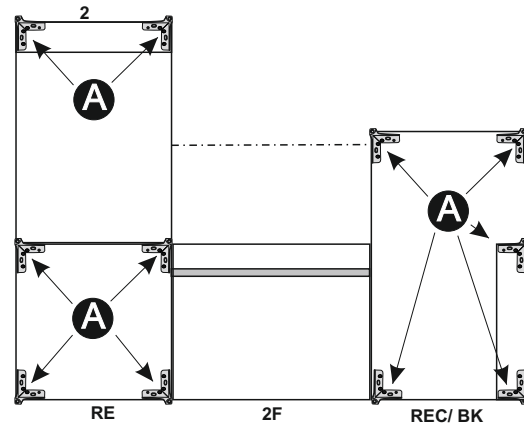
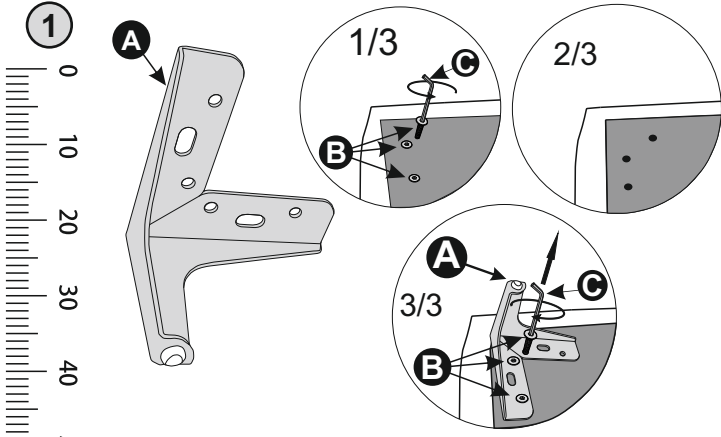
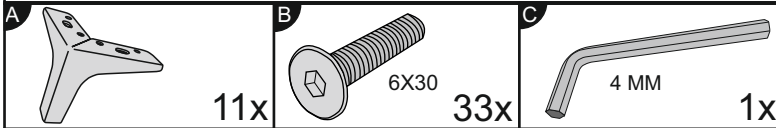

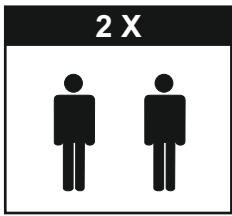

- | | |
|----------------------------------|-------------------------------|
| (D) AUFBAUANLEITUNG | (GB) ASSEMBLY INSTRUCTIONS |
| (NL) HANDLEIDING VOOR DE MONTAGE | (PL) INSTRUKCJA MONTAŻU |
| (TR) MONTAJ TALIMATI | (RU) Инструкция по монтажу |
| (RO) INSTRUCTIUNI DE ASAMBLARE | (I) PROCEDURA DI ASSEMBLAGGIO |
| (F) INSTRUCTION D'ASSEMBLAGE | (SK) POKYNY K MONTÁŽI |
| (CZ) POKYNY K MONTÁŽI | (HU) KÖZGYŰLÉS UTASÍTÁSOK |
| (BG) ИНСТРУКЦИИ ЗА МОНТАЖ | (SLD) ASSEMBLY INSTRUCTIONS |
| (HR) NAPUTCI ZA MONTAŽU | (S) MONTERINGSANVISNING |
| (E) INSTRUCCIONES DE MONTAJE | (LT) DIEGIMO INSTRUKCIJOS |



**„SAMMY”
REC/ BK-2F-RE-2**

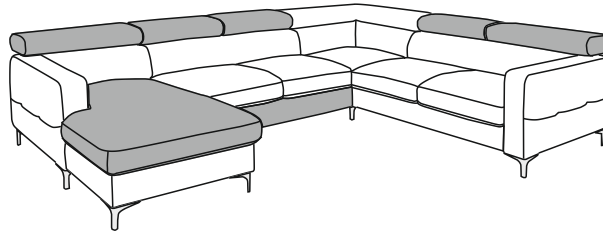

2/2

