

Skien

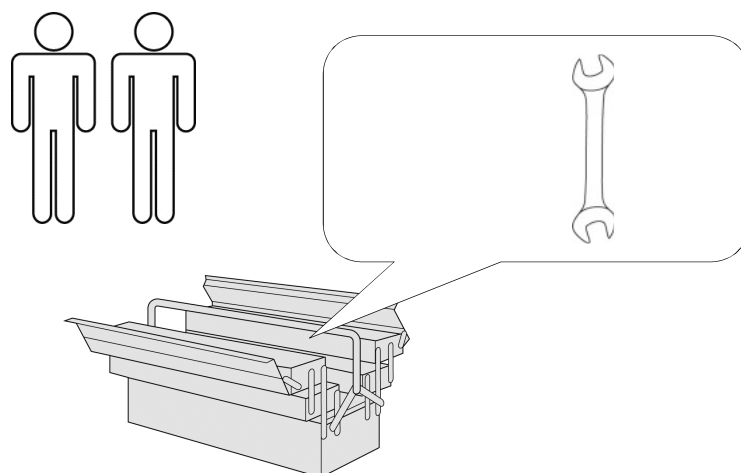





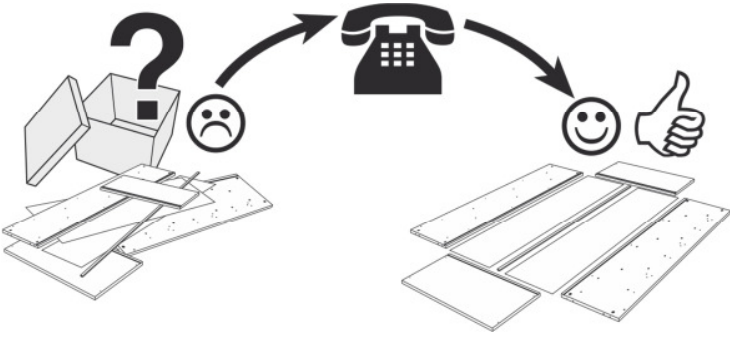
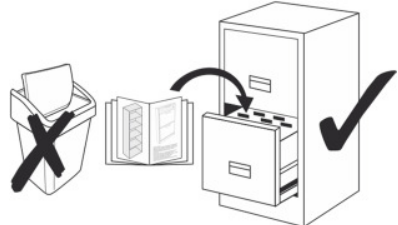

- | | |
|----------------------------------|---------------------------------------|
| D Montageanleitung | GB Assembly instructions |
| FR Notice de montage | NL Handleiding voor de montage |
| CZ Montážní návod | IT Istruzioni di montaggio |
| RO Instrucțiuni de montaj | RU инструкция по сборке |
| PL Instrukcja montażu | SK Návod na montáž |
| HU Szerelési útmutató | TR Montaj talimatı |

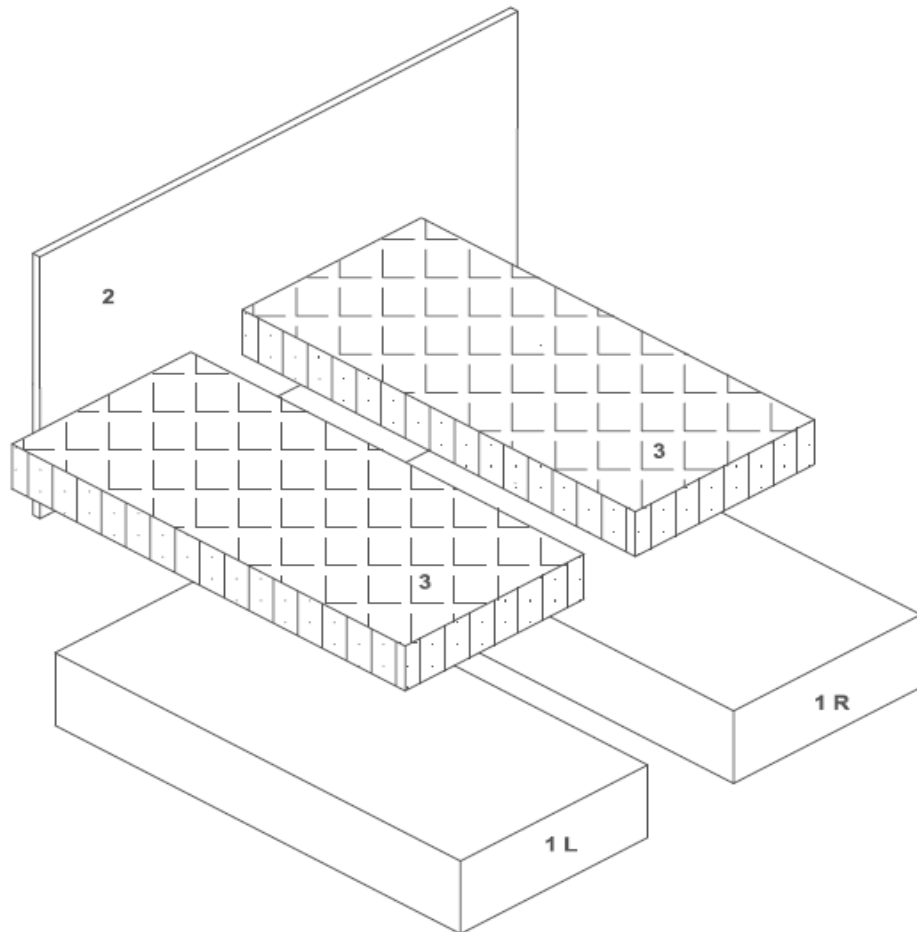





0
10
20
30
40
50
60
70
80
90
100
110
120
130
140
150
160
170
180
190
200

Service • Assistenza • Dienstverlening • Serwis Servis • Szerviz • Сервисная служба	
Name • Nom • Nome • Naam Nazwa • Jméno • Názov • Név Denumire • Ísim • Название	Skien DB
Nr. • No. • N° • Номер • Č • Sz	SH50
Typ • Type • Tip • Típus • Tipo Тип	BS K
	
	

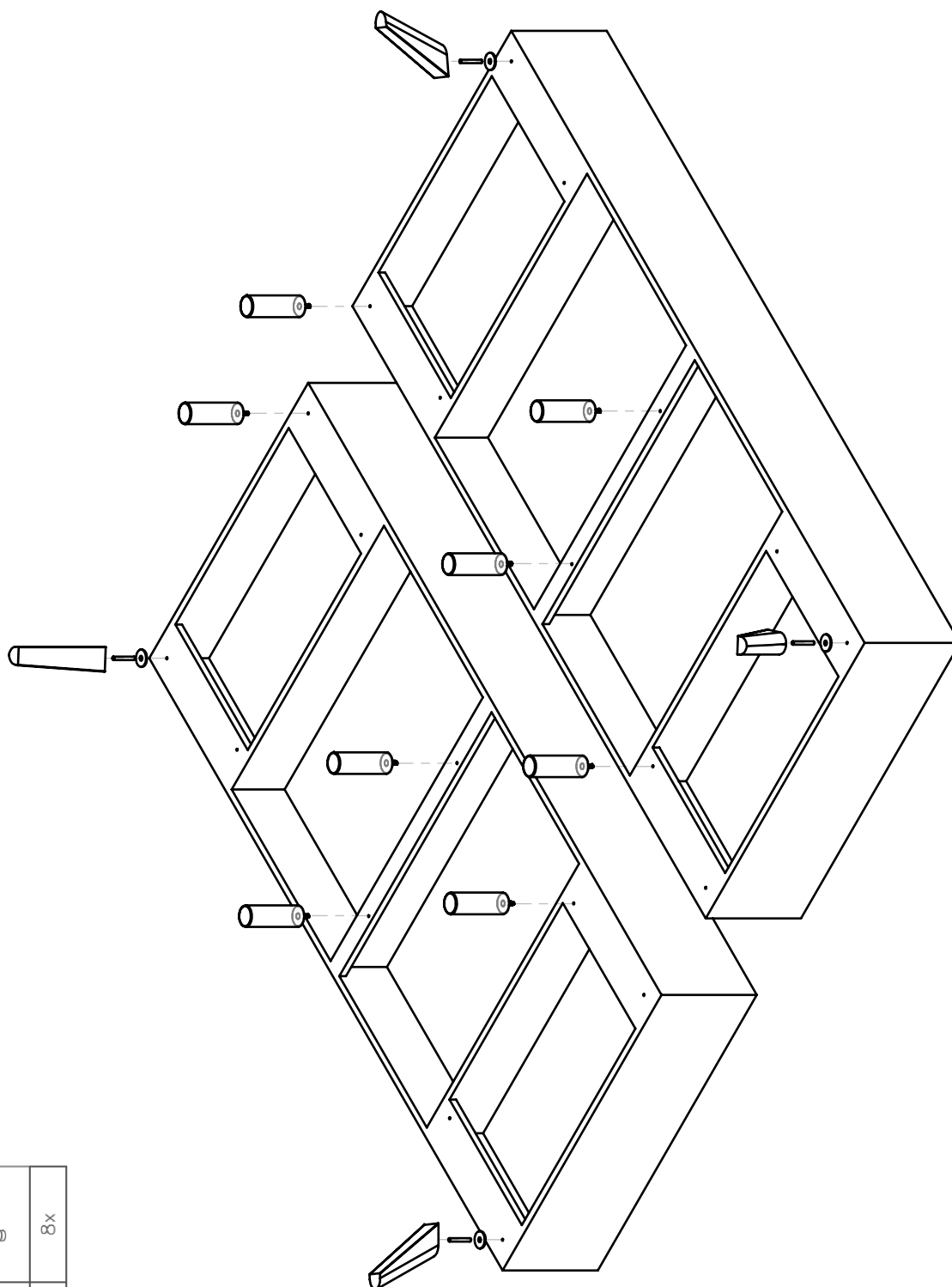

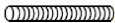

A	B	C	D	E	F
					
4x	4x 8x45	12x 8x40	8x	8x 8x60	8x M8

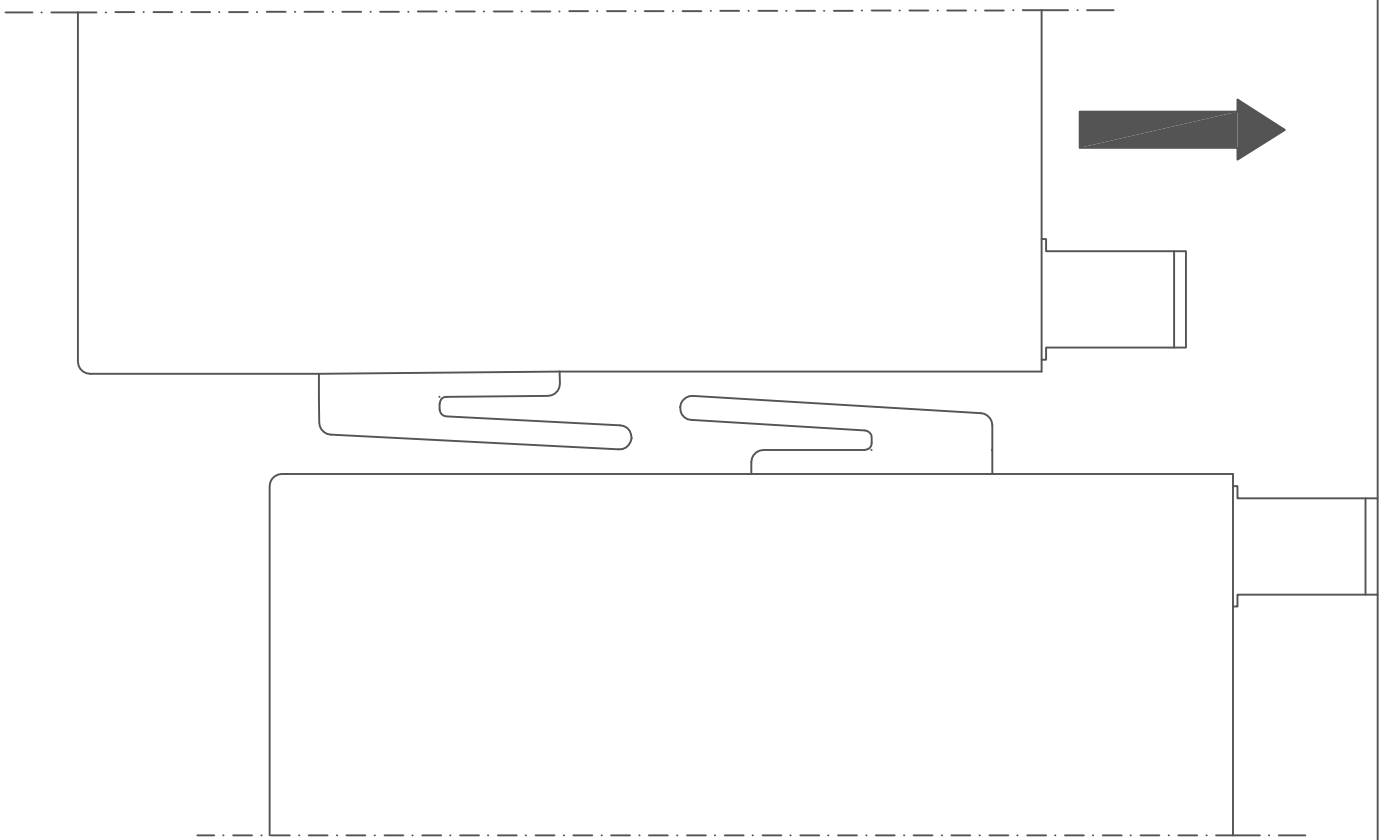

A		4x
B		4x 8x45
C		4x 8x40
D		8x

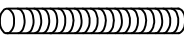

3.

E		C		F		<p>Achtung! Schrauben nicht überdrehen FR Attention! Ne serrez pas trop CZ Dávej Pozor! Nepřetahujte RO Ai Grija! Nu strângeți PL Uważaj! Nie dokręcać zbyt mocno HU Vigyázz! Ne húzza túl</p> <p>GB Watch Out! Do not over tighten NL Let Op! Niet te vast IT Attento! Non stringere RU Осторожно! Не затягивайте SK Dávaj Pozor! Nepretahujte TR Dikkat! Üzerinde sıkmayın</p>
8x 8x60		8x 8x40		8x M8		

