

# SHELFY

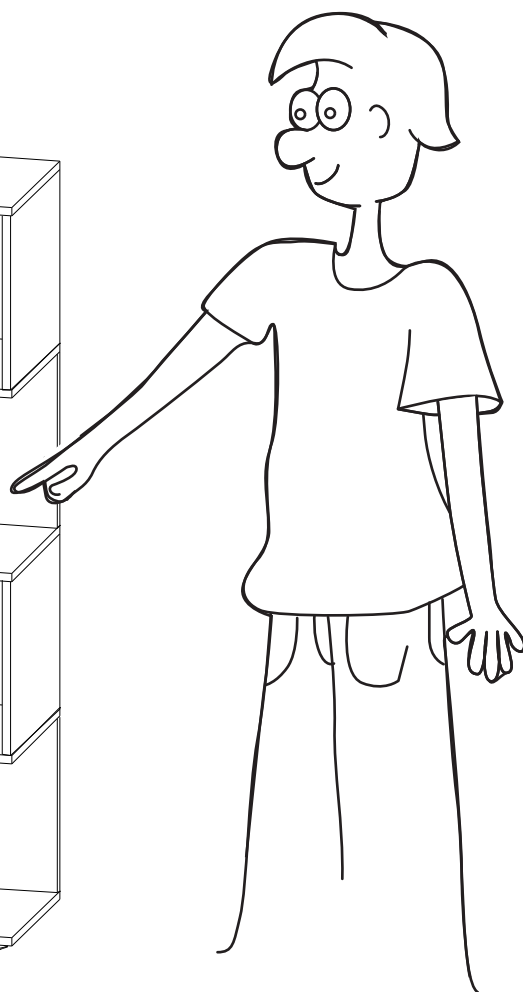

ITM: 126234  
146,1x103x35,6cm

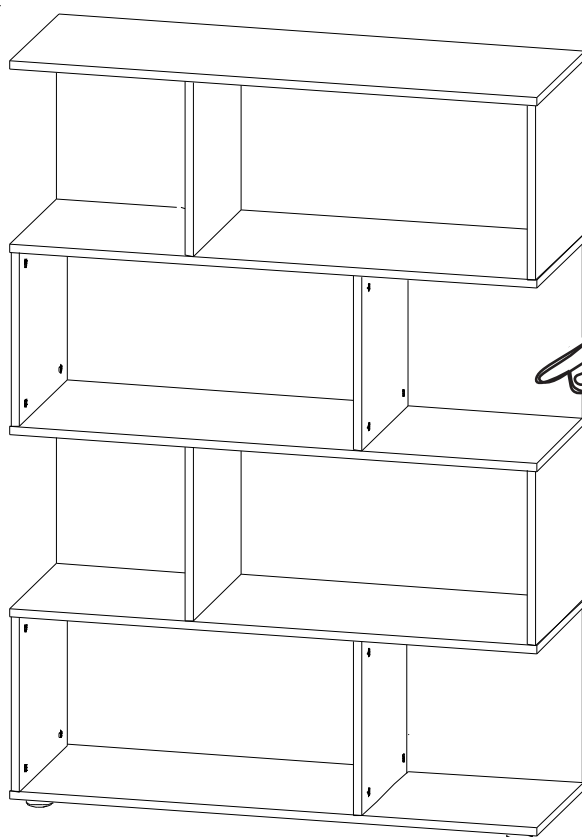

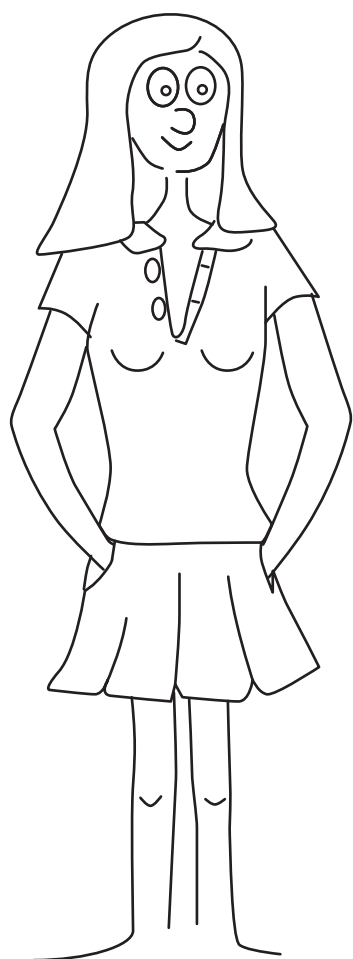
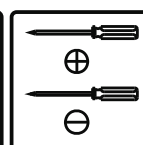
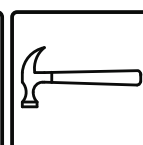
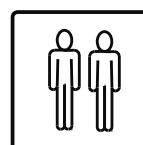
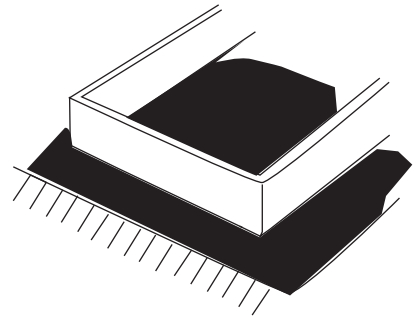
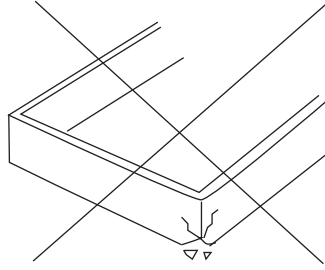
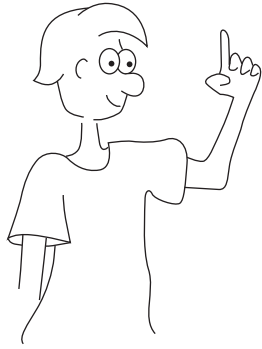

ø8x30  
a 52x



b 56x



c 56x



d 16x



e 16x

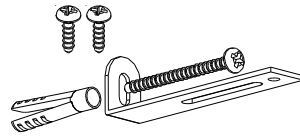

i 1x

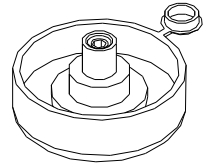

f 5x

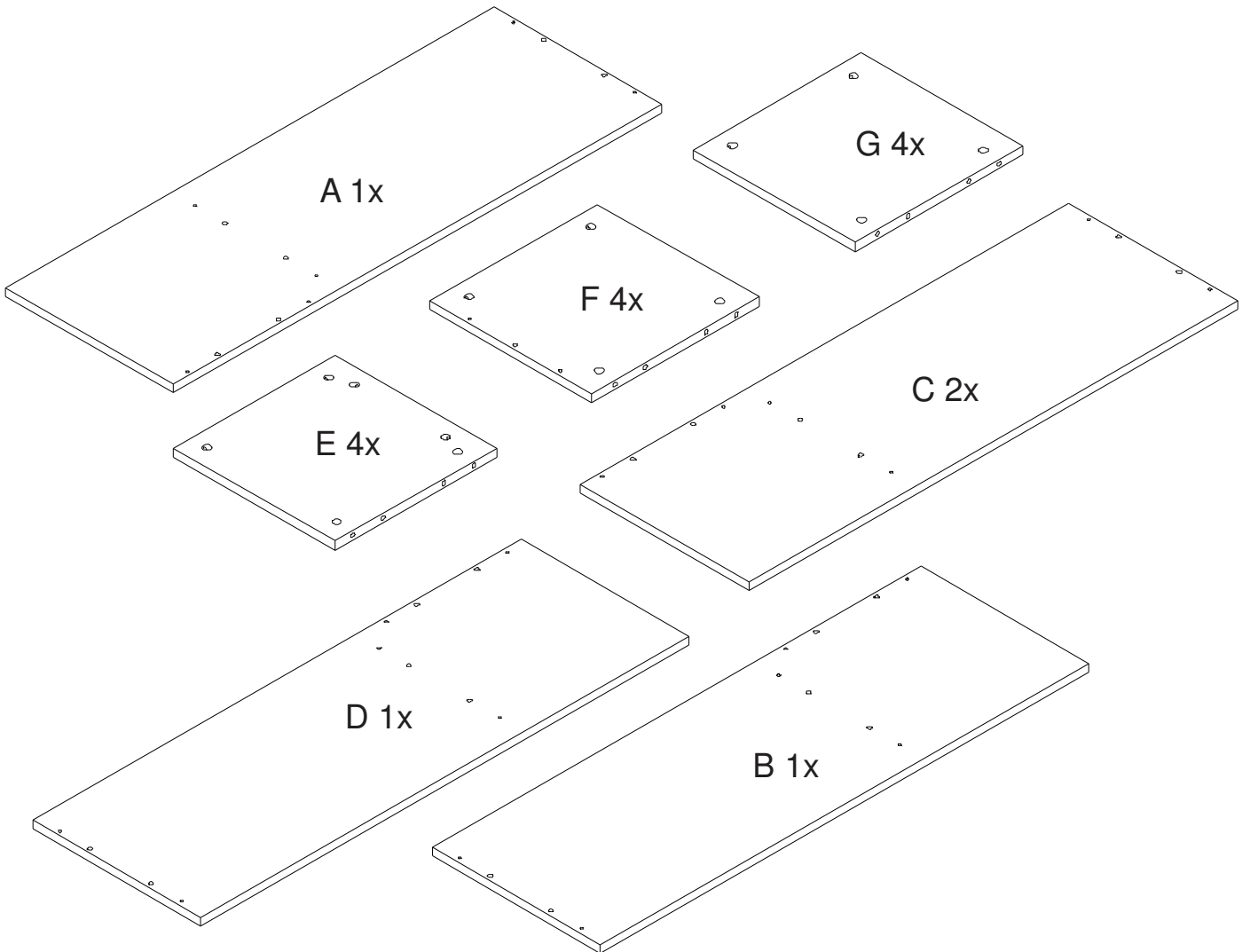

1

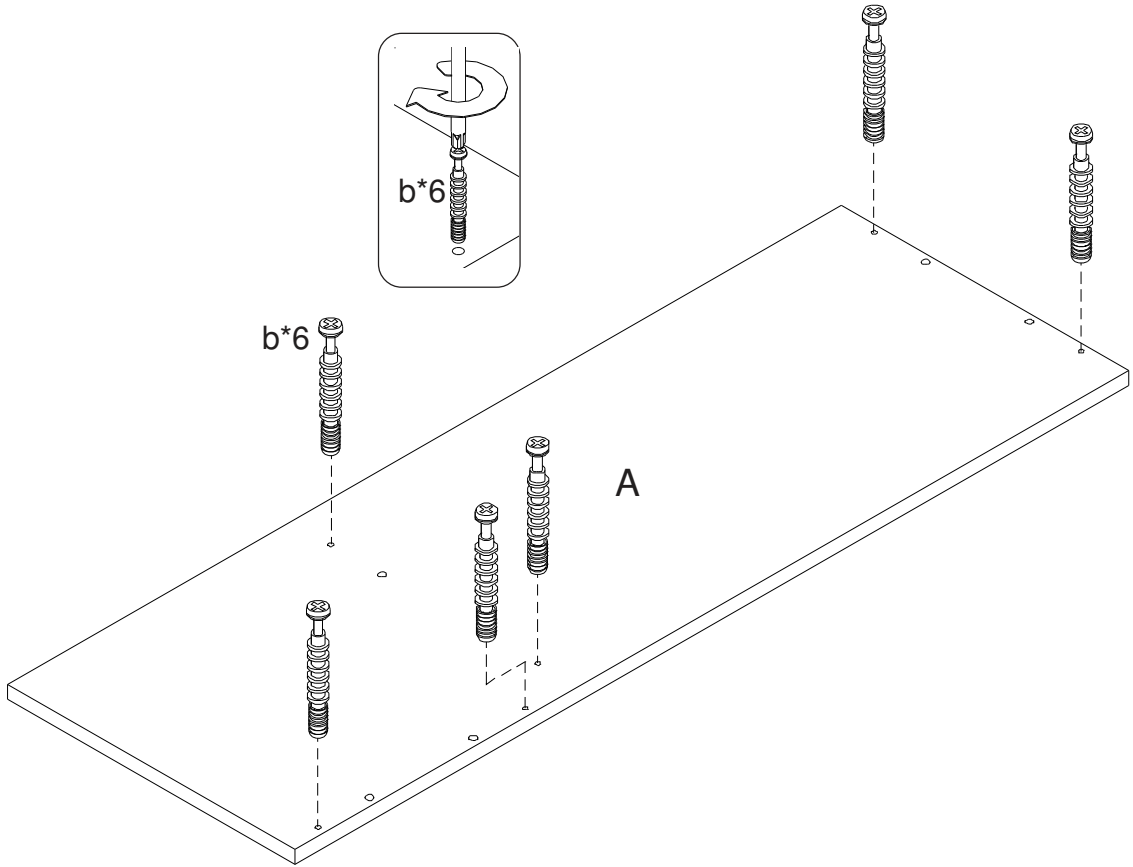

b\*6

2

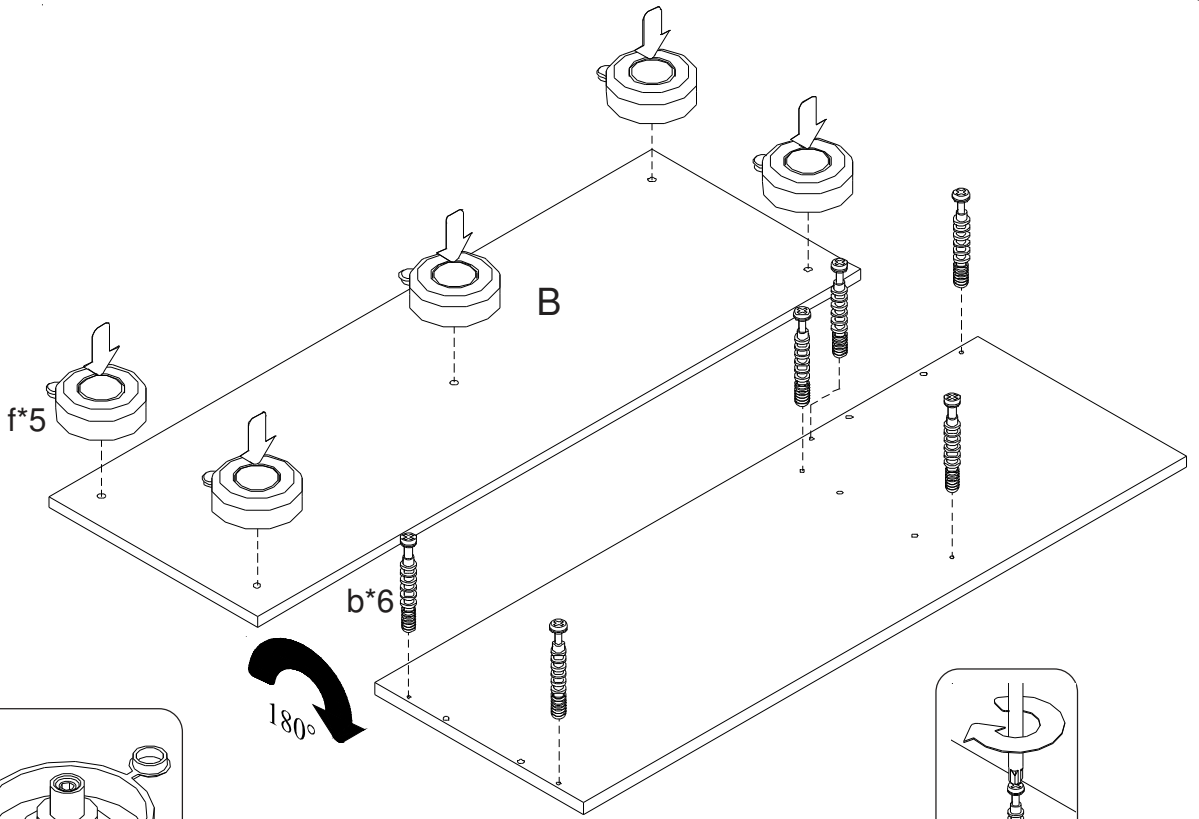

b\*6

f\*5

b\*6

3

2x

b\*24

C

b\*24



b\*24



180°

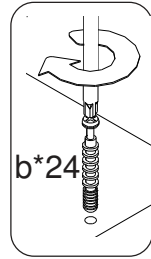

4

b\*12

D

b\*12



b\*12



180°

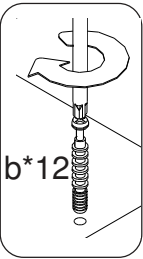

5

4x

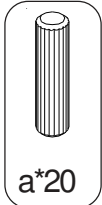
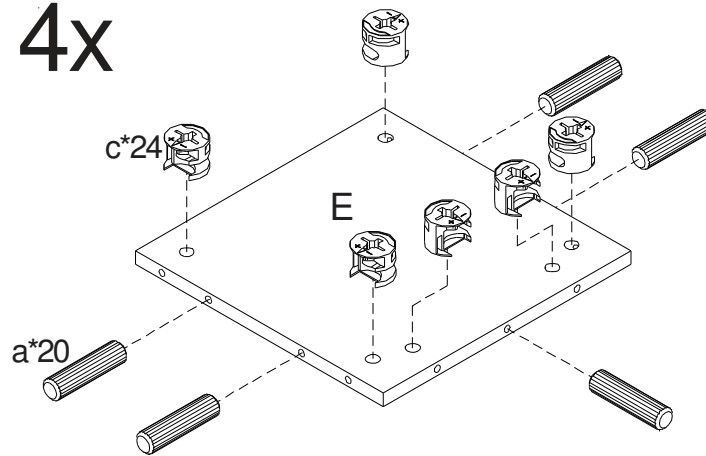

6

4x

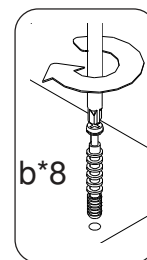
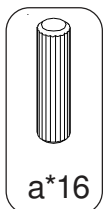
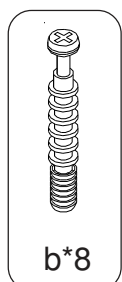
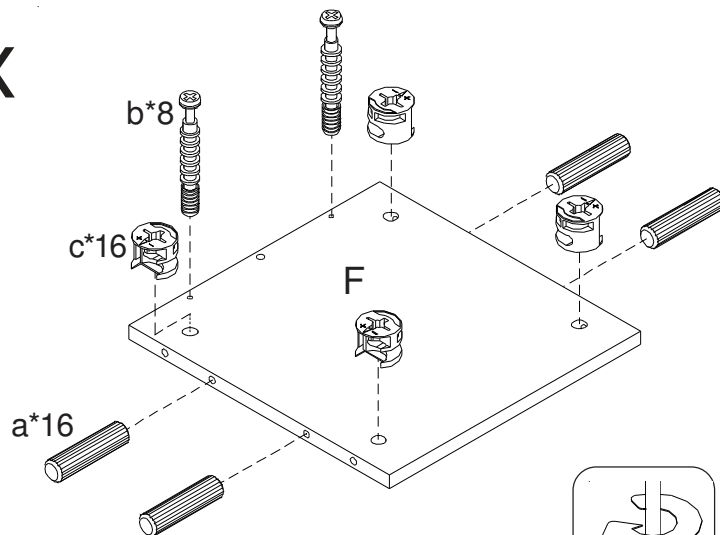

7

4x

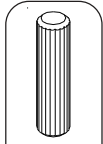
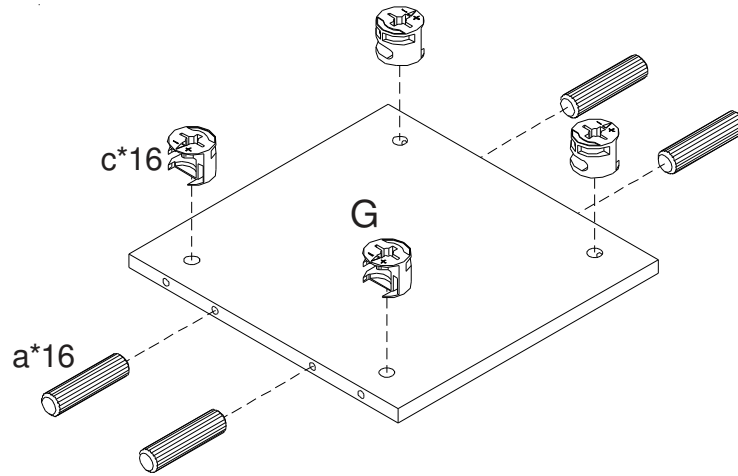

a\*16

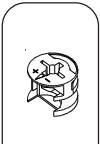

c\*16

8

4x

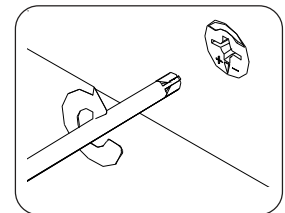
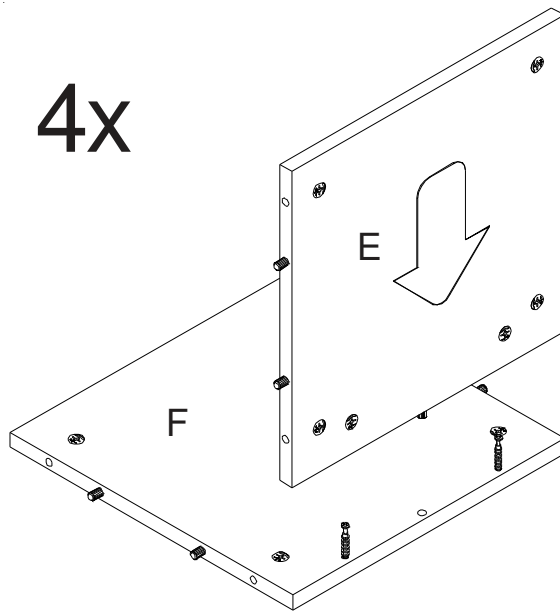

# 9

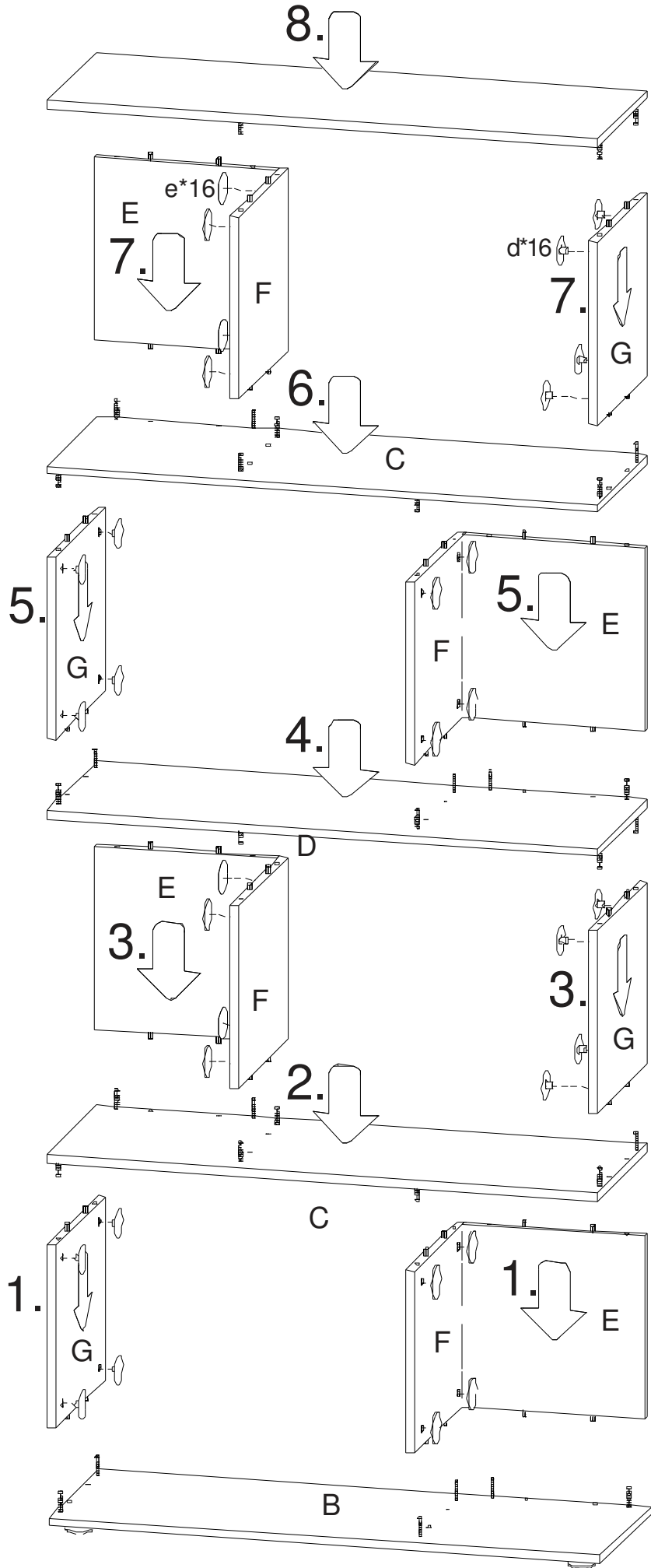
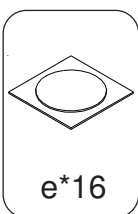
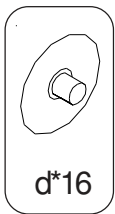
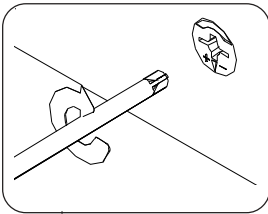
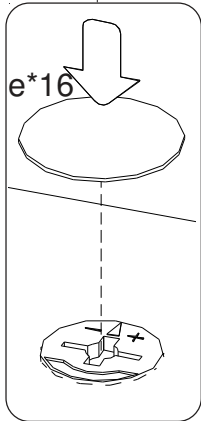
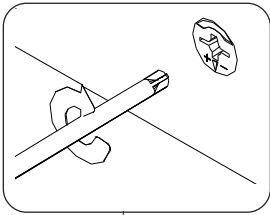

10

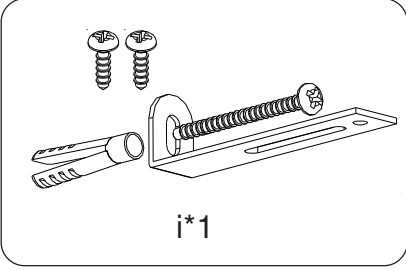
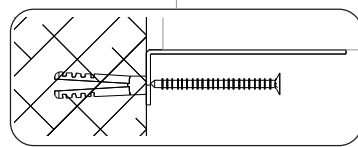
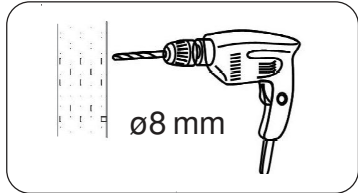
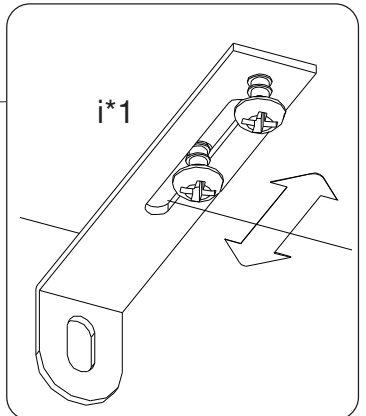
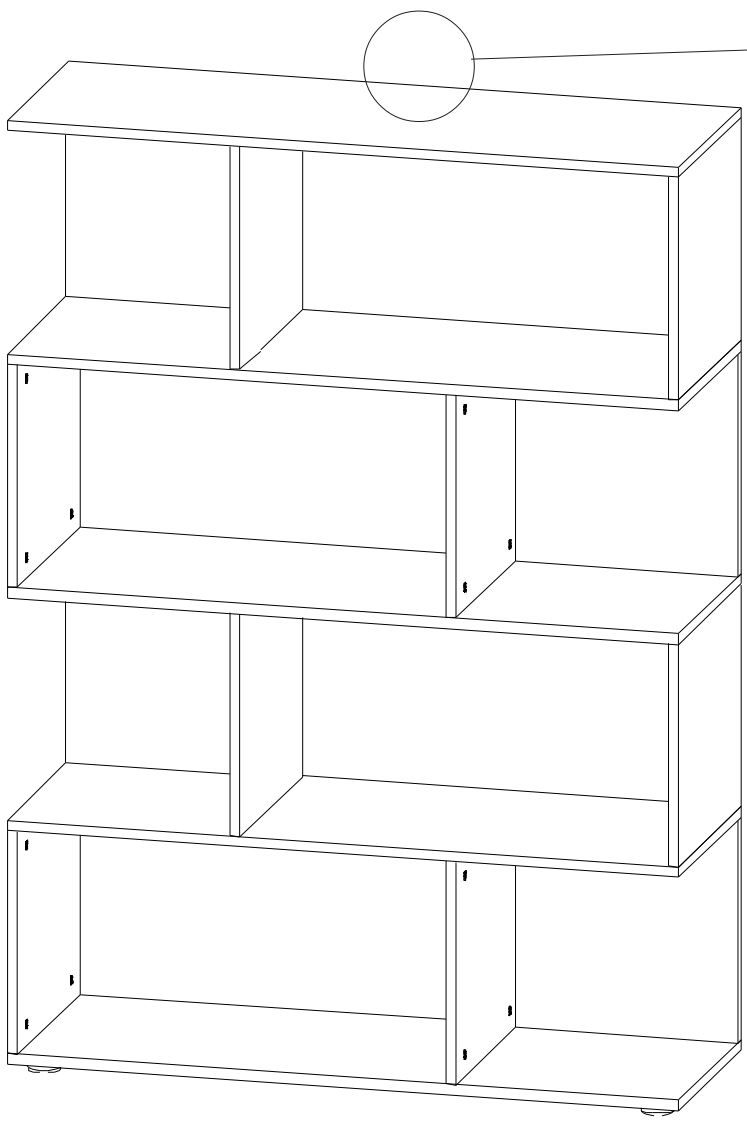
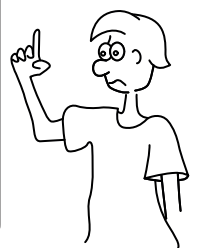
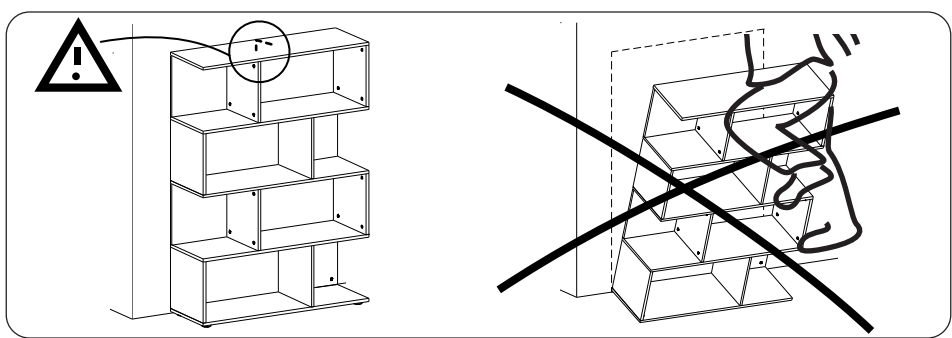
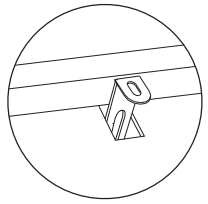



- DE WICHTIG! - FÜR SPÄTERES NACHSCHLAGEN AUFBEWAHREN! SORGFÄLTIG LESEN!
- GB ATTENTION! - PLEASE STORE FOR FURTHER ENQUIRIES! READ CAREFULLY!
- FR IMPORTANT! - CONSERVER POUR UNE UTILISATION ULTÉRIEURE - LIRE ATTENTIVEMENT!
- ES ¡ATENCIÓN! - GUARDAR PARA UN USO POSTERIOR. - LÉASE DETENIDAMENTE!
- PT IMPORTANTE! – GUARDAR PARA FUTURAS CONSULTAS – LER COM ATENÇÃO!
- IT IMPORTANTE! CONSERVARE PER L'USO FUTURO - LEGGERE CON ATTENZIONE!
- NL BELANGRIJK! - BEWAAR DE HANDLEIDING VOOR LATERE RAADPLEGING!  
ZORGVULDIG LEZEN!
- DK VIGTIGT! BØR OPBEVARES TIL SENERE BRUG - SKAL LÆSES GRUNDIGT!
- SE VIKTIGT! SPARAS FÖR FRAMTIDA BRUK - MÅSTE LÄSAS NOGA!
- FI TÄRKEÄÄ! - SÄILYÄ MYÖHEMPÄÄ KÄYTTÖÄ VARTEN – LUE TARKKAAVAISESTI!
- NO VIKTIG! – OPPBEVARES FOR SENERE BRUK – MÅ LESES NØYE!
- PL WAŻNE! ZACHOWAĆ NA PRZYSZŁOŚĆ! STARANNIE PRZECZYTAĆ!
- CZ DŮLEŽITÉ! - NÁVOD SI USCHÓVEJTE PRO POZDĚJŠÍ POUŽITÍ! - PEČLIVĚ SI JEJ PROČTĚTE!
- HU FONTOS! – KÉSŐBBI FELHASZNÁLÁSRA ÓRIZZE MEG – GONDOSAN OLVASSA EL!
- HR VAŽNO! - SAČUVATI ZA KASNIJU UPORABU – PAŽLJIVO PROČITATI!
- RO IMPORTANT! - PĂSTRĂȚI PENTRU UTILIZARE ULTERIOARĂ - CITIȚI CU ATENȚIE!
- RS VAŽNO! – ČUVATI ZA KASNIJU UPOTREBU – PAŽLJIVO SVE PROČITATI!
- SK DÔLEŽITÉ! - NÁVOD UCHOVAJTE NA NESKORŠIE POUŽITIE –  
DÔKLADNE SI HO PREČÍTAJTE!
- SI POMEMBNO! – SHRANITE ZA KASNEJŠO UPORABO – TEMELJITO PREBERITE!
- TR ÖNEMLİ!-DAHA SONRA KULLANILMAK ÜZERE DE MUHAFZA EDİNİZ–  
DIKKATLE OKUYUNUZ!
- GR ΣΗΜΑΝΤΙΚΟ! - ΝΑ ΦΥΛΑΣΣΕΤΑΙ ΓΙΑ ΑΡΓΟΤΕΡΗ ΧΡΗΣΗ - ΝΑ ΔΙΑΒΑΖΕΤΑΙ ΜΕ ΠΡΟΣΟΧΗ!
- RU ВАЖНО: ВНИМАТЕЛЬНО ПРОЧТИТЕ И СОХРАНИТЕ!

# Sicherheitshinweise

- DE** - **Achtung:** Das beiliegende Wandbefestigungsmaterial ist nur für Massivwände geeignet, bei anderen Wänden müssen Spezialdübel verwendet werden! Vor dem Bohren den Verlauf von Strom- und Wasserleitungen unbedingt überprüfen und berücksichtigen!  
- Benutzen Sie zu Reinigung nur milde Reinigungs- und Pflegemittel.
- GB** - **Attention!** The furniture must be attached to the wall for safety reasons and to increase its stability. The wall attached material only suitable for solid walls. Special wallpugs must be used for other walls! Check for electric power and water lines before drilling!  
- Please use for cleaning only mild detergent and care products.
- FR** - **Attention!** Pour des raisons de sécurité et afin d'augmenter la stabilité, le meuble doit être fixé au mur. Le matériel de fixation murale joint n'est adapté qu'aux murs pleins, pour les autres types de murs, des chevilles spéciales doivent être utilisées! Avant de percer, vérifiez et prenez en compte le tracé des câbles électriques et des conduites d'eau!  
- Pour le nettoyage, utilisez uniquement des produits nettoyeurs ou d'entretien doux.
- ES** - **Atención:** El material incluido para la sujeción mural sólo es adecuado para paredes macizas; para otras paredes deben utilizarse tacos especiales. Antes de taladrar es imprescindible comprobar y tener en cuenta el recorrido de los cables eléctricos y las tuberías de agua.  
- Para limpiar utilice productos de limpieza y cuidados suaves.
- PT** - **Atenção:** O material fornecido para fixação à parede destina-se apenas a paredes maciças. Para outro tipo de parede é necessário utilizar buchas especiais! Antes de furar a parede, assegure-se que não passam canos de água ou cabos eléctricos no local onde pretende furar!  
- Para limpar e cuidar, utilize somente produtos de limpeza não abrasivos.
- IT** - **Avvertenza:** Il materiale di fissaggio accluso è adatto solo per pareti massicce. Per altri tipi di pareti occorre utilizzare tasselli speciali! Prima di eseguire la perforazione, controllare il tracciato delle linee elettriche e delle condutture idriche per non danneggiarle!  
- Per la pulizia si raccomanda di usare solo detergenti e mezzi manutentivi non aggressivi.
- NL** - **Let op!** Om veiligheidsredenen en om de stabiliteit te verhogen, moet het meubelstuk aan de muur worden bevestigd. Het daarvoor bijgevoegde bevestigingsmateriaal is uitsluitend voor massieve muren geschikt. Voor andere muren moeten speciale pluggen worden gebruikt! Alvorens te boren, dient het verloop van elektriciteits waterleidingen te worden gecontroleerd. Houd hier rekening mee!  
- Gebruik voor de reiniging alleen zachte reinigings- en onderhoudsproducten.
- DK** - **Vigtigt:** Det medfølgende materiale til vægfastgørelse er kun egnet til massive vægge. Ved alle andre vægge skal der anvendes specialdybler! Inden der foretages boring skal det ubetinget kontrolleres, hvor el- og vandledningerne er lagt, således at der kan tages hensyn til dette!  
- Benyt kun milde rengørings- og plejemidler til rengøringen.
- SE** - **OBS!** Medföljande material för väggmontering är endast lämpligt för massiva väggar, för andra väggar krävs specialpluggar! Innan du borrar: kontrollera var el- och vattenledningar finns och undvik att borra i närheten av dem!  
- Använd endast milda rengörings- och vårdmedel för rengöring.
- FI** - **Huomio:** Mukana tulevat seinäkiinnitysmateriaalit soveltuvat ainoastaan massiivisiin seiiniin, kaikissa muissa seinätyypeissä on käytettävä erikoistulppia! Tarkasta ehdottomasti sähkö- ja vesilinjojen kulku ennen poraamista ja ota ne huomioon!  
- Käytä puhdistukseen ainoastaan mietoja puhdistus- ja hoitoaineita.
- NO** - **Gi akt:** Veggfeste materialet som følger med er kun egnet for massive vegger, på andre vegger må det bli brukt spesialplugger! Før man begynner med boringen, kontroller og ta hensyn til hvor strøm- og vannledningene går!  
- For rengjøring bruker du kun milde rengjørings- og vedlikeholdsmidler.
- PL** - **Uwaga:** Dołączony materiał do mocowania nadaje się tylko do ścian masywnych, w przypadku innych ścian należy stosować specjalne kołki rozporowe! Przed wierceniem sprawdzić koniecznie przebieg przewodów elektrycznych i wodociągowych!  
- Do czyszczenia używać tylko łagodnych środków czyszczących i pielęgnacyjnych.
- CZ** - **Upozornění:** Příložený materiál pro připevnění ke zdi je vhodný pouze pro masivní zdi, u jiných typů zdí je třeba použít speciální hmoždinky! Než začnete vrtat, nezapomeňte v každém případě zkontrolovat, zda těmito místy neprochází elektrická vedení a vodovodní potrubí, a tuto skutečnost zohledněte při vrtání!  
- K čištění používejte jen šetrné čističí a ošetřovací prostředky.
- HU** - **Figyelem!** A mellékelt fali szerelőanyagok csak tömör falakon használhatók; egyéb falak esetén speciális tipliket kell alkalmazni! Fúrás előtt okvetlenül át kell vizsgálni, hogy a fúrás helyén futnak-e áram- és vízvezetékek! Ha igen, azokat figyelembe kell venni!  
- A tisztításhoz csak gyenge tisztító- és ápolószereket használjon.
- HR** - **Pozor!** Priloženi pričvrtni materijal za pričvršćenje na zid prikladan je samo za masivne zidove dok se kod drugih zidova trebaju upotrijebiti moždanci! Prije bušenja obavezno proverite i uzeti u obzir tijek vodova za truju i vodu!  
- Za čišćenje koristite blaga sredstva za čišćenje i njege.
- RO** - **Atenție:** Materialul atașat pentru fixare în perete este adecvat numai pentru pereți masivi; în cazul altor pereți trebuie utilizate dibluri speciale! Înainte de găurire, verificați neapărat și aveți în vedere traseul conductorilor electrici și al conductelor de apă!  
- Folosiți pentru curățare numai produse fine de curățare și îngrijire.
- RS** - **Pažnja:** Priloženi materijal za pričvršćivanje na zid pogodan je samo za masivne zidove, kod drugih vrsta zidova moraju da se koriste specijalni tiplovi! Pre bušenja, obavezno proverite i vodite računa o trasama električnih i vodovodnih vodova!  
- Za čišćenje koristite samo blaga sredstva za čišćenje i negu.
- SK** - **Pozor:** Priložený materiál pre pripevnenie na stenu je vhodný iba pre masívne steny. V prípade iných stien je potrebné použiť špeciálne hmoždinky! Pred začatím vrtania bezpodmienečne skontrolujte a dbajte na umiestnenie elektrických vedení a vodovodných potrubí!  
- Na čistenie používajte iba jemné čistiace a ošetrovacie prostriedky.
- SI** - **Pozor:** Priložen material za pritrditev na steno je primeren le za masivne stene, pri vseh ostalih stenah je treba uporabiti poseben čep! Pred vrtanjem obvezno preverite, kje tečejo vodovodni in električni vodi ter se jim izognite!  
- Za čiščenje uporabljajte le blaga čistilna in negovalna sredstva.
- TR** - **Dikkat:** Ekte bulunan ve duvara sabitlemeye yarayan malzeme sadece masif duvarlar için uygundur, diğer duvarlarda ise özel dübellerin kullanılması gerekir. Delme işleminden önce mutlaka elektrik ve su borularının nereden geçtiği kontrol edilmeli ve bu bilgi dikkate alınmalıdır.  
- Temizlik için sadece hafif temizlik ve bakım maddelerini kullanınız.
- GR** - **Προσοχή:** Το εσώκλειστο υλικό στερέωσης στον τοίχο είναι κατάλληλο μόνο για συμπαγείς τοίχους, σε περίπτωση άλλων τοίχων πρέπει να χρησιμοποιούνται ειδικά ούλα! Πριν τη διάτρηση του τοίχου να ελέγχετε και να λαμβάνετε οπωσδήποτε υπόψη σας τη διαδρομή των αγωγών ρεύματος και νερού!  
- Για τον καθαρισμό να χρησιμοποιείτε μόνο ήπιες ουσίες καθαρισμού και συντήρησης.
- RU** - **Внимание:** крепежные детали, входящие в комплект поставки, подходят только для монолитных стен, для других используются специальные дюбели! Перед сверлением обязательно проверьте, не пролегают ли в данном месте линии проводки и водяные трубы!  
- Для чистки используйте только мягкие моющие средства и средства по уходу.



QUALITY:



RESISTANCE:

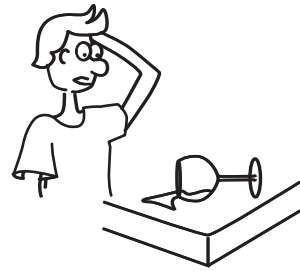

alcohol/tea

water/oil

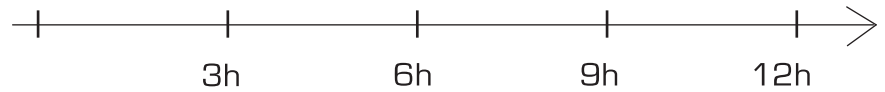

RESPONSIBILITY:

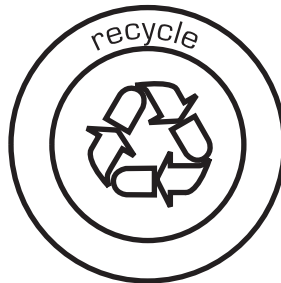

INFO:



+41 41 780 38 08



info@phoenix-group.ch



www.phoenix-home.info



www.phoenix home info

