

**D****Wichtige Pflegehinweise**

Bitte beachten Sie die wichtigen Pflegehinweise auf unserer Internetseite

www.till-hilft.de

Pflegehinweise

**PL****Ważne instrukcje dotyczące pielęgnacji**

Zwróć uwagę na ważną instrukcję dotyczącą pielęgnacji na naszej stronie internetowej

www.till-hilft.de

Pflegehinweise

**GB****Important care instructions**

Please note the important care instructions on our website

www.till-hilft.de

Pflegehinweise

**SK****Dôležité pokyny na starostlivosť**

Dbajte na dôležité pokyny týkajúce sa starostlivosti na našich webových stránkach

www.till-hilft.de

Pflegehinweise

**FR****Instructions d'entretien importantes**

S'il vous plaît noter les instructions de soins importants sur notre site Web

www.till-hilft.de

Pflegehinweise

**HU****Fontos kezelési utasítások**

Kérjük, vegye figyelembe a honlapunkon található fontos kezelési útmutatót

www.till-hilft.de

Pflegehinweise

**IT****Importanti istruzioni per la cura**

Si prega di notare le importanti istruzioni per la cura sul nostro sito web

www.till-hilft.de

Pflegehinweise

**RO****Instrucțiunile importante de îngrijire**

Rețineți instrucțiunile importante de îngrijire de pe site-ul nostru

www.till-hilft.de

Pflegehinweise

**NL****Belangrijke zorginstructies**

Let op de belangrijke zorginstructies op onze website

www.till-hilft.de

Pflegehinweise

**TR****Önemli bakım talimatları**

Lütfen web sitemizdeki önemli bakım talimatlarını dikkate alınız

www.till-hilft.de

Pflegehinweise

**CZ****Důležité pokyny pro péči**

Vezměte prosím na vědomí důležité pokyny pro péči na našich webových stránkách

www.till-hilft.de

Pflegehinweise

**RU****Важные инструкции по уходу**

Обратите внимание на важные инструкции по уходу на нашем веб-сайте

www.till-hilft.de

Pflegehinweise





87239.533

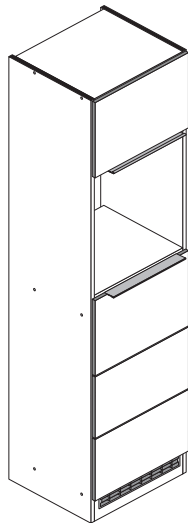

Variante A: ohne Kühlschrank

Variante B: mit Kühlschrank

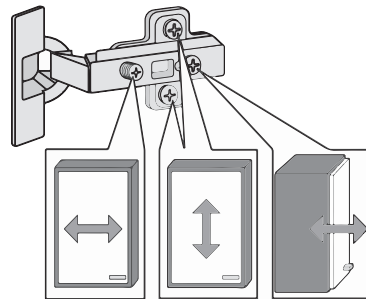
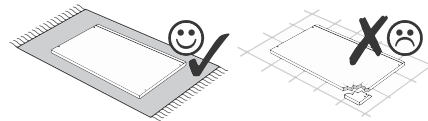
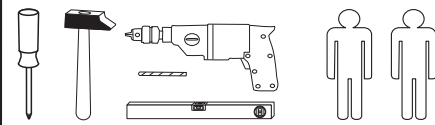

Beschlagteile im Boden-Colli

1 12 x 2827	2 12 x	3 8 x 30 36 x 2861	4 5/5 x 16 8 x 2821
6 1 x 4940	7 2 x 2532	8 1 x 2845	9 6 x 34 1 x 2844
10 4 x 45 1 x 2814	11 3,5 x 15 9 x 2804	12 4 x 15 1 x 2810	13 4 x 2865
14 25 x 2862	15 4 x 9 5 x 30 2 x 1 x	16 Leim 1 x 2863	

Beschlagteile im Fronten-Colli

17 4 x 1503	18 4 x 1611
19 2 x	20 3,5 x 15 6 x 2804
21 6 x 1119	22 6 x 1125
34 35 mm 2 x 2886	

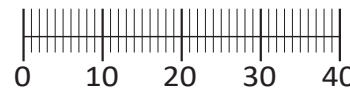

Das beigefügte Wandbefestigungsmaterial (Dübel und Schrauben) eignet sich nur für festes Mauerwerk (z.B.: Beton- oder Ziegelwände). Für andere Wandaufbauten sind eventuell Spezialdübel und andere Schrauben notwendig. Ziehen Sie gegebenenfalls eine Fachkraft zu Rate.

De begeleidende wandmontage hardware (pluggen en schroeven) is alleen geschikt voor massief metselwerk (bijvoorbeeld beton of bakstenen muren). Voor andere muur structuren zijn eventueel bijzondere ankerbouten en andere noodzakelijke. Draai indien nodig, een deskundige.

Приложенный материал для крепления к стене (дюбели и винты) пригоден только для жестких кладок (например, бетонные или кирпичные стены). Для других настенных конструкций необходимы смотря по обстоятельствам специальные дюбели и другие винты. При необходимости проконсультируйтесь у специалиста.

Le mur d'accompagnement matériel de montage (chevilles et les vis) ne convient que pour la maçonnerie solide (par exemple en béton ou des murs de briques). Pour les structures de mur d'autres sont peut-être spéciale boulons d'ancrage et d'autres nécessaires. Serrer le cas échéant, un expert.

Załączony materiał do mocowania do ściany (kolki rozprężne i wkręty) nadaje się tylko do ścian murowanych (np. z betonu lub cegiel). Do ścian wykonanych w innych technologiach konieczne być mogą specjalne kolki rozprężne i inne wkręty. W razie potrzeby skorzystaj z fachowej pomocy

Il muro di accompagnamento hardware di montaggio (tasselli e viti) è'e adatto solo per muratura piena (ad esempio calcestruzzo o muratura). Per le altre strutture murarie sono forse speciali bulloni di ancoraggio e necessari di altri. Serrare se necessario, un esperto.

The accompanying wall mounting hardware (anchors and screws) is suitable only for solid masonry (eg concrete or brick walls). For other wall structures are possibly special anchor bolts and other necessary. Tighten if necessary, an expert.

Ekteki duvarlar sabit montaj malzemeleri (dübel ve vidalar), sadece sağlam duvarlar için (örnek: beton veya tuğla) elverişlidir. Başka duvarlar için özel dübeller ve farklı vidalar gerekebilir. Gerektiğinde bir uzmana danışınız.

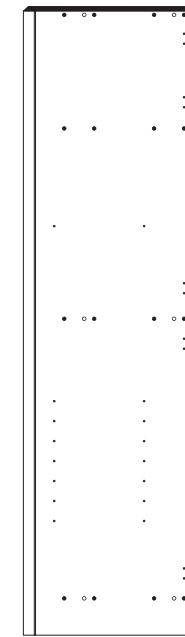

23 1 x

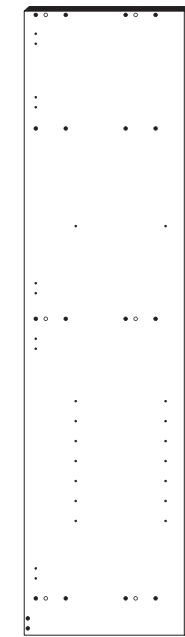

24 1 x

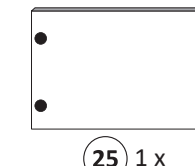

25 1 x

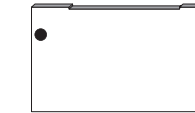

26 1 x

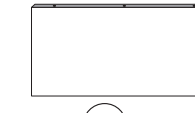

27 1 x

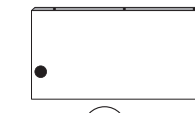

28 1 x

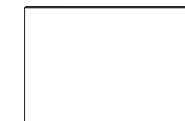

29 1 x

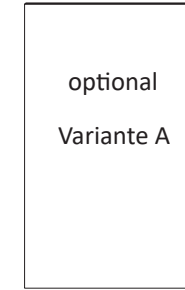

optional Variante A

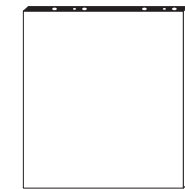

31 4 x

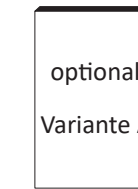

optional Variante A

32 2 x



33 1 x

1



4 5/5 x 16 8 x 2821	18 4 x 1611
---------------------------	----------------

Bitte beachten !

In dieser Aufbauanleitung ist die Tür rechts angeschlagen. Soll die Tür links angeschlagen werden, müssen die Kreuzmontageplatten 18 auf das linke Seitenteil 24 montiert werden.

Bitte beachten !

Die Bodenträger 4 nur bei Variante ohne Kühlschrank anbringen.

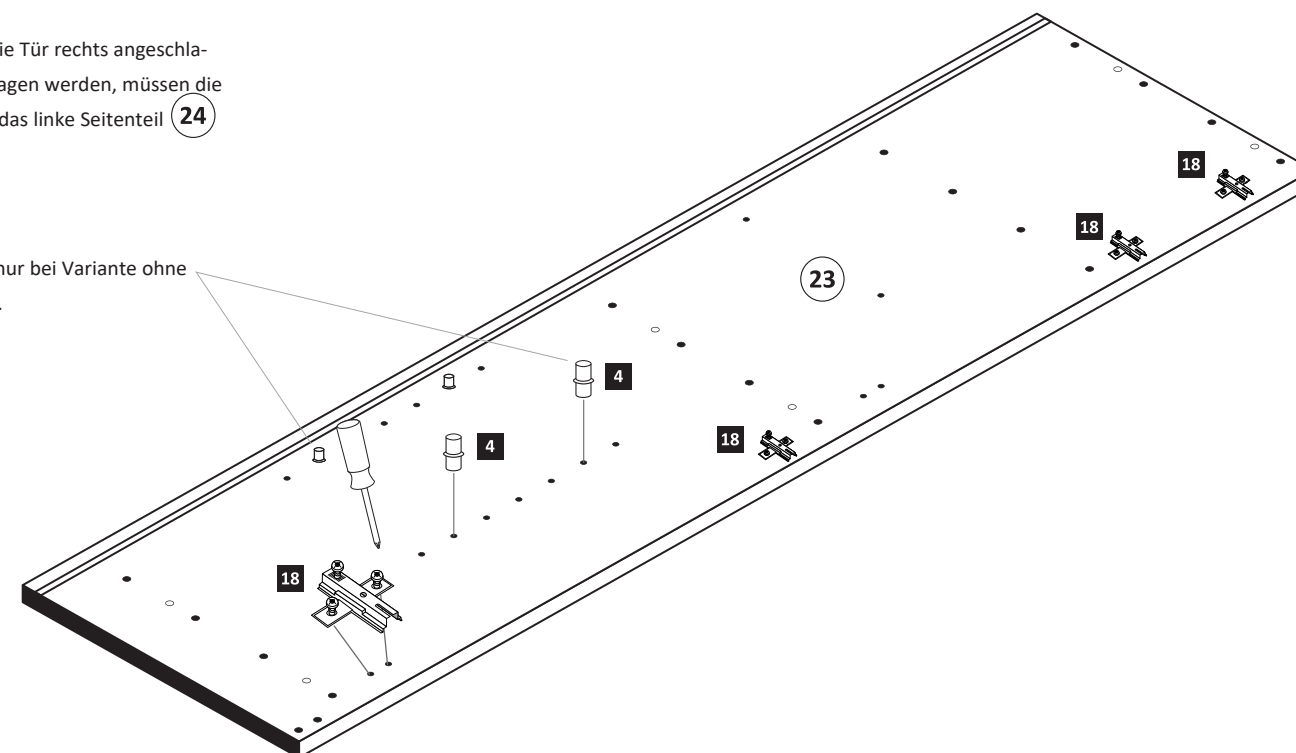
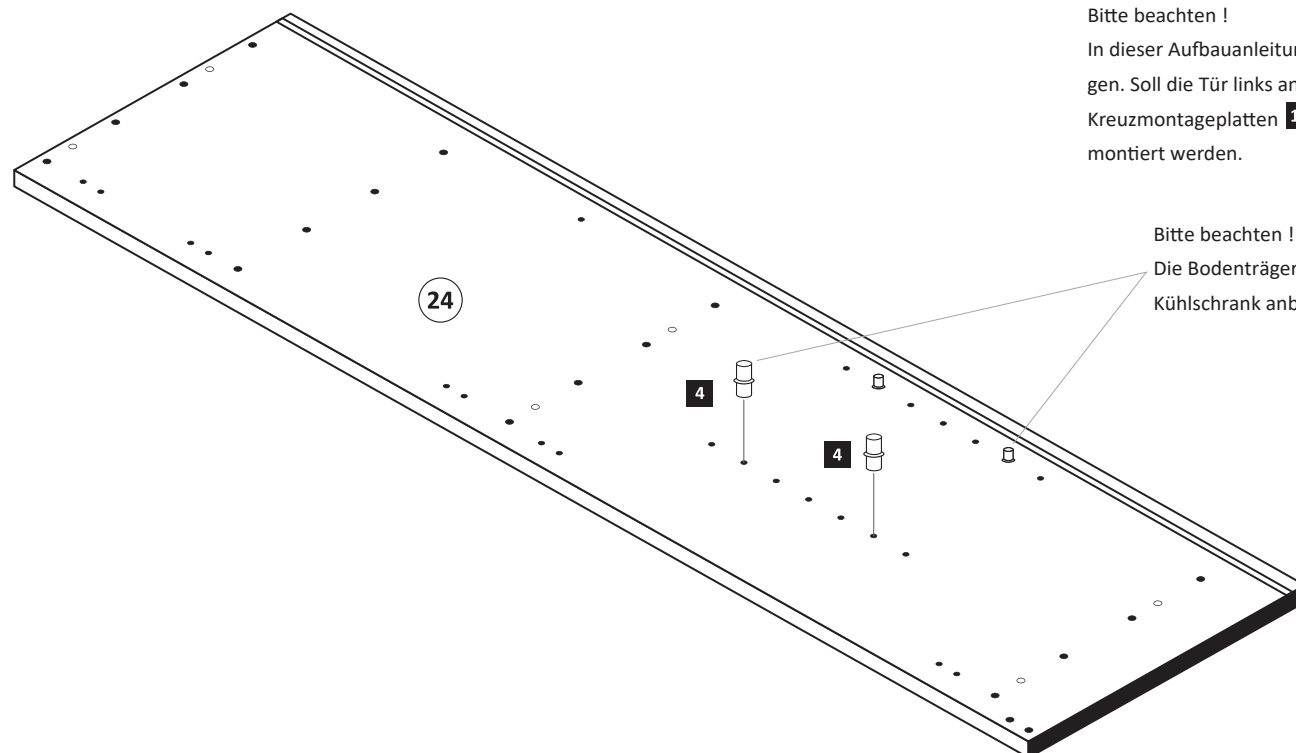

2

3	8 x 30 36 x 2861	6	1 x 4940
7	2 x 2532	16	1 x 2863

31 4 x

33

Leim 16

3

1	12 x 2827	2	12 x
---	--------------	---	------

16

31

23

24

31

31

33

Leim 16

20 min.

16	1 x 2863
----	-------------

D Leim
GB Glue
NL Lijm
PL Klej
TR Tutkal
F Colle
I Colla

4

14	25 x 2862
----	--------------

Variante A

Variante B

29

30

14

5

11	3,5 x 15 4 x 2804	13	2 x 2865	17	2 x 1503
19	1 x	20	3,5 x 15 3 x 2804		

17

19

20

25

Mitte Front

13

13

ACHTUNG!
Montagebeispiel Rechtsanschlag
Bei Linksanschlag andere
Griffleiste gegenüber montieren!

6

21	6 x 1119	22	6 x 1125
----	-------------	----	-------------

16

26

27

28

Leim 16

20 min.

16	1 x 2863
----	-------------

D Leim
GB Glue
NL Lijm
PL Klej
TR Tutkal
F Colle
I Colla

7

11	3,5 x 15 4 x 2804	13	2 x 2865	17	2 x 1503	34	2 x 2886
19	1 x	20	3,5 x 15 3 x 2804				

11

13

17

19

20

26

27

28

34

13

Mitte Front

ACHTUNG!
Montagebeispiel Rechtsanschlag
Bei Linksanschlag andere
Scharnierbohrung verwenden!

8

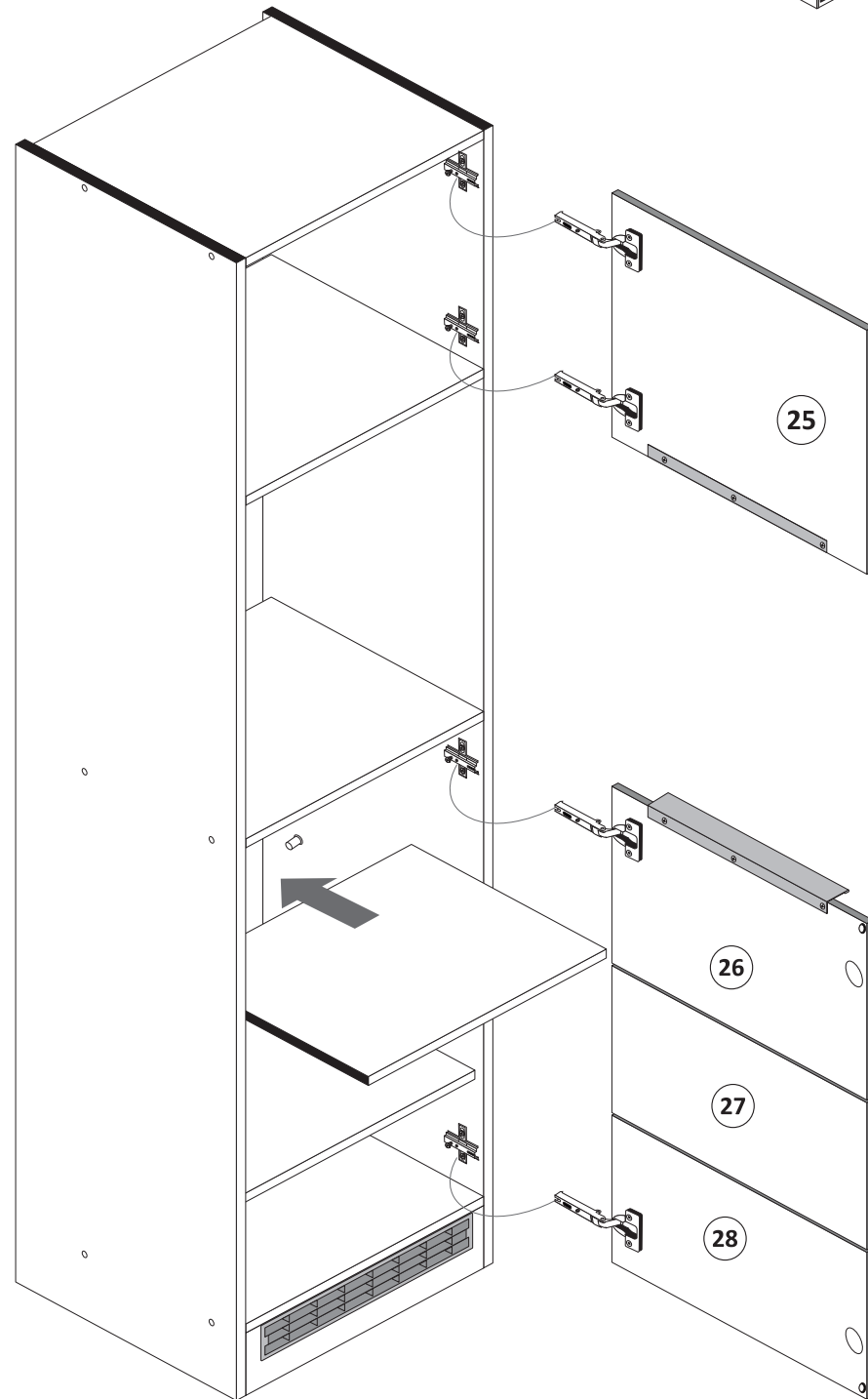

Variante A

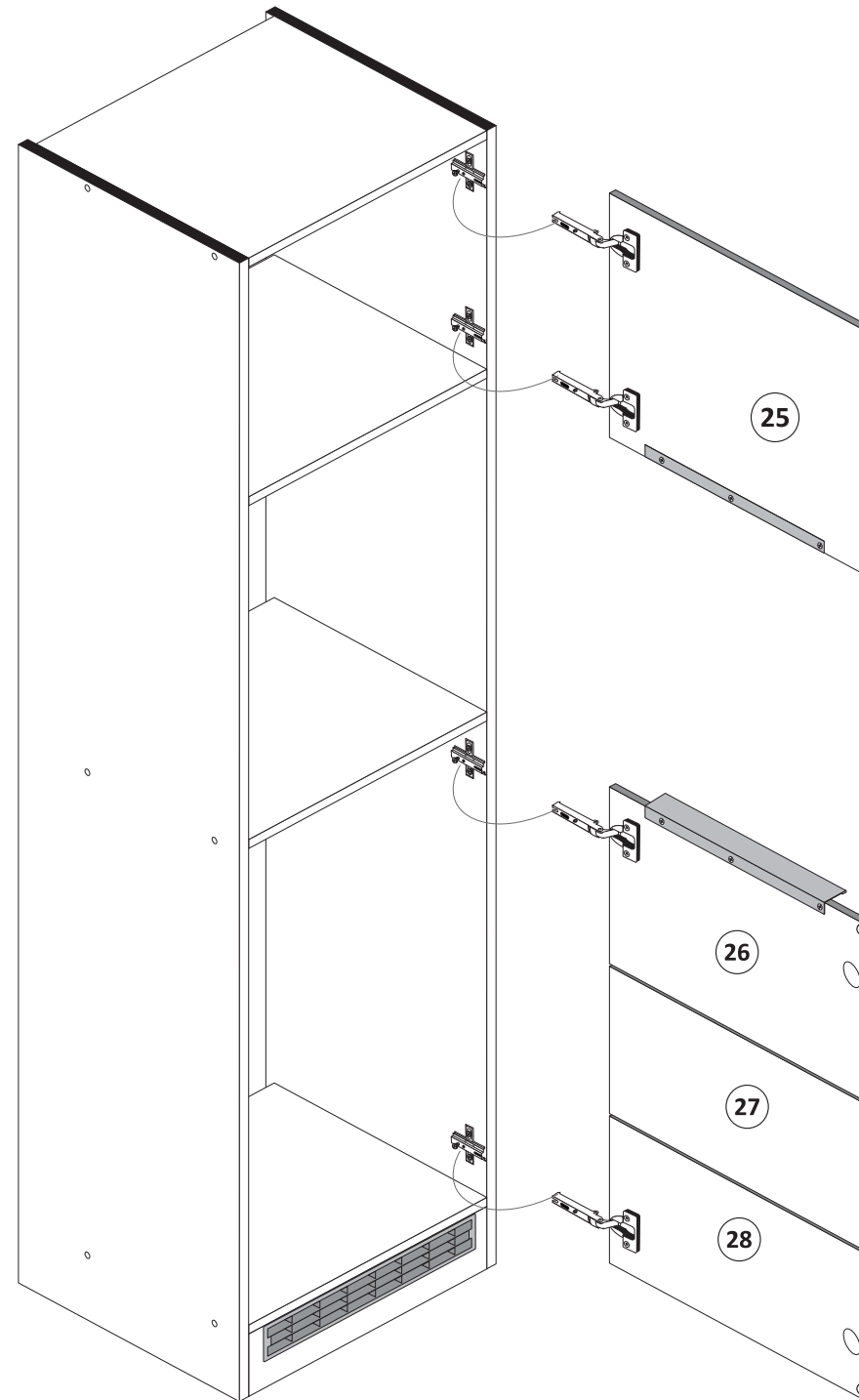

Variante B



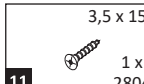
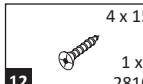

9

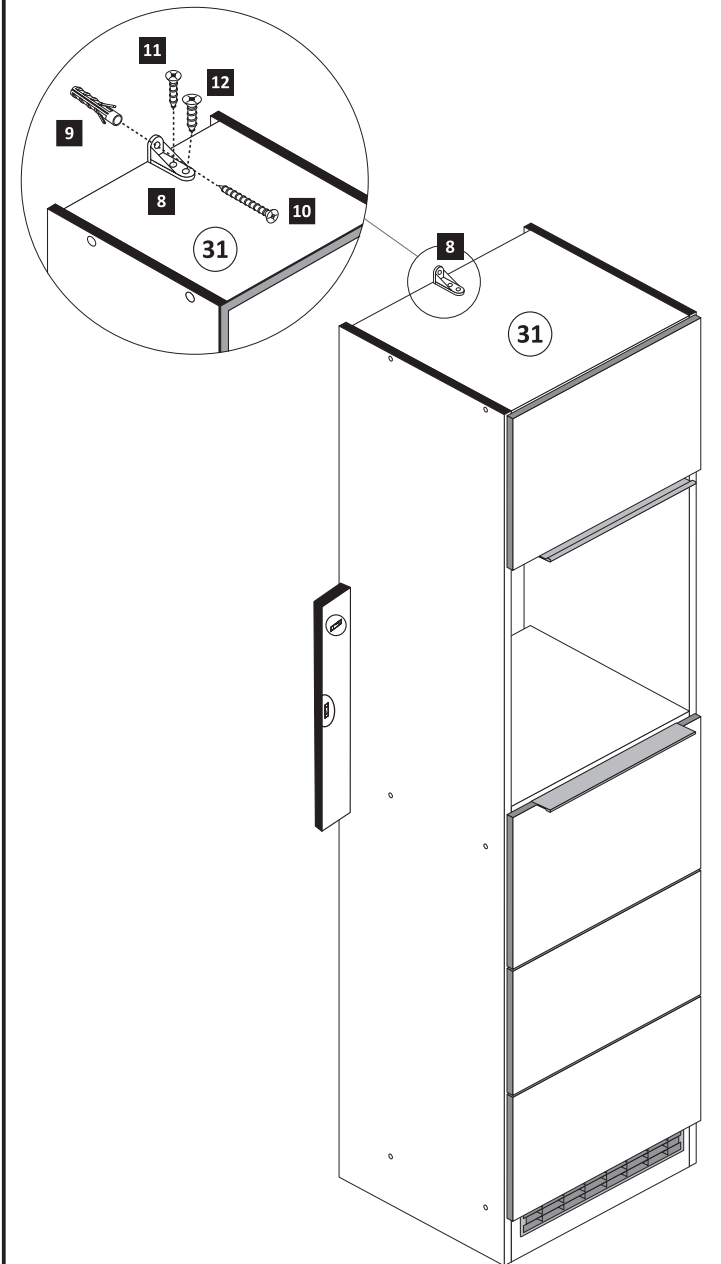
 1 x 2845	 1 x 2844	 1 x 2814
 1 x 2804	 1 x 2810	



10

 2 x 4 x 9	 1 x 5 x 30
--	---

