

Art. Nr. 27671864; 17310831

LKZ 40605

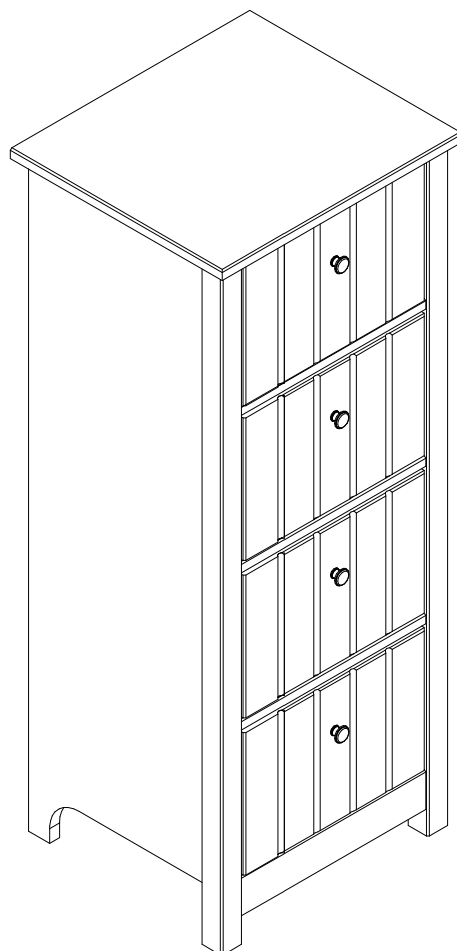

- |           |                                    |           |                                |
|-----------|------------------------------------|-----------|--------------------------------|
| <b>D</b>  | <b>Montageanleitung</b>            | <b>GB</b> | <b>Assembly instructions</b>   |
| <b>FR</b> | <b>Notice de montage</b>           | <b>IT</b> | <b>Istruzioni di montaggio</b> |
| <b>NL</b> | <b>Handleiding voor de montage</b> | <b>PL</b> | <b>Instrukcja montażu</b>      |
| <b>CZ</b> | <b>Montážní návod</b>              | <b>SK</b> | <b>Návod na montáž</b>         |
| <b>HU</b> | <b>Szerelési útmutató</b>          | <b>RO</b> | <b>Instrukțiuni de montaj</b>  |
| <b>TR</b> | <b>Montaj talimatı</b>             | <b>RU</b> | <b>Инструкция по монтажу</b>   |

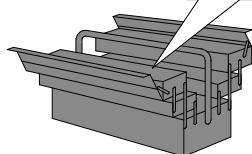
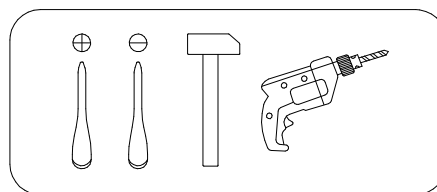
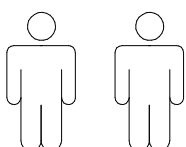

# Service · Dienstverlening · Serwis · Servis · Сервисная служба

Name · Naam · Nazwa · Isim · Название

Nr. · No. · Номер

Typ · Type · Tip · Тип

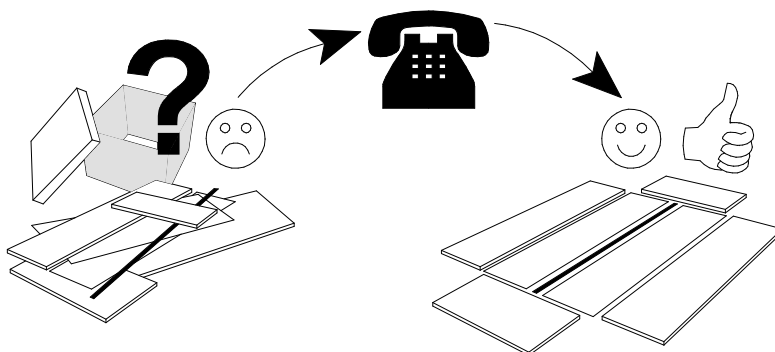
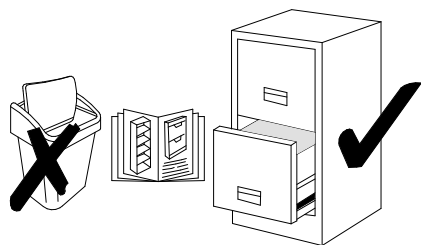

N	Size/MaB (mm)	Qty	✓
1	340×300	1	
2	260×268	1	
3	836×260	1	
4	836×260	1	
5	836×30	1	
6	836×30	1	
7	260×86	3	
8	260×50	1	
9	774×278	1	
10	256×175	4	
11	250×94	4	
12	250×94	4	
13	226×94	4	
14	246×235	4	

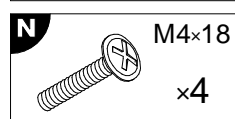
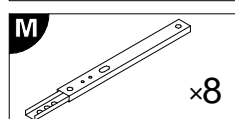
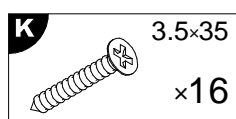
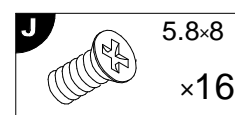
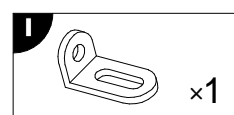
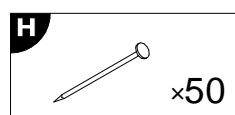
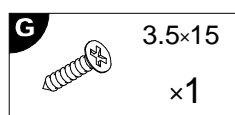
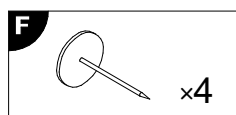
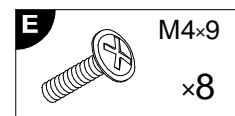
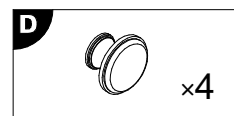
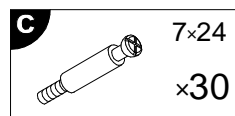
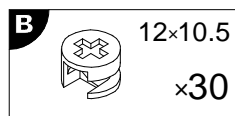
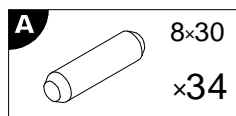

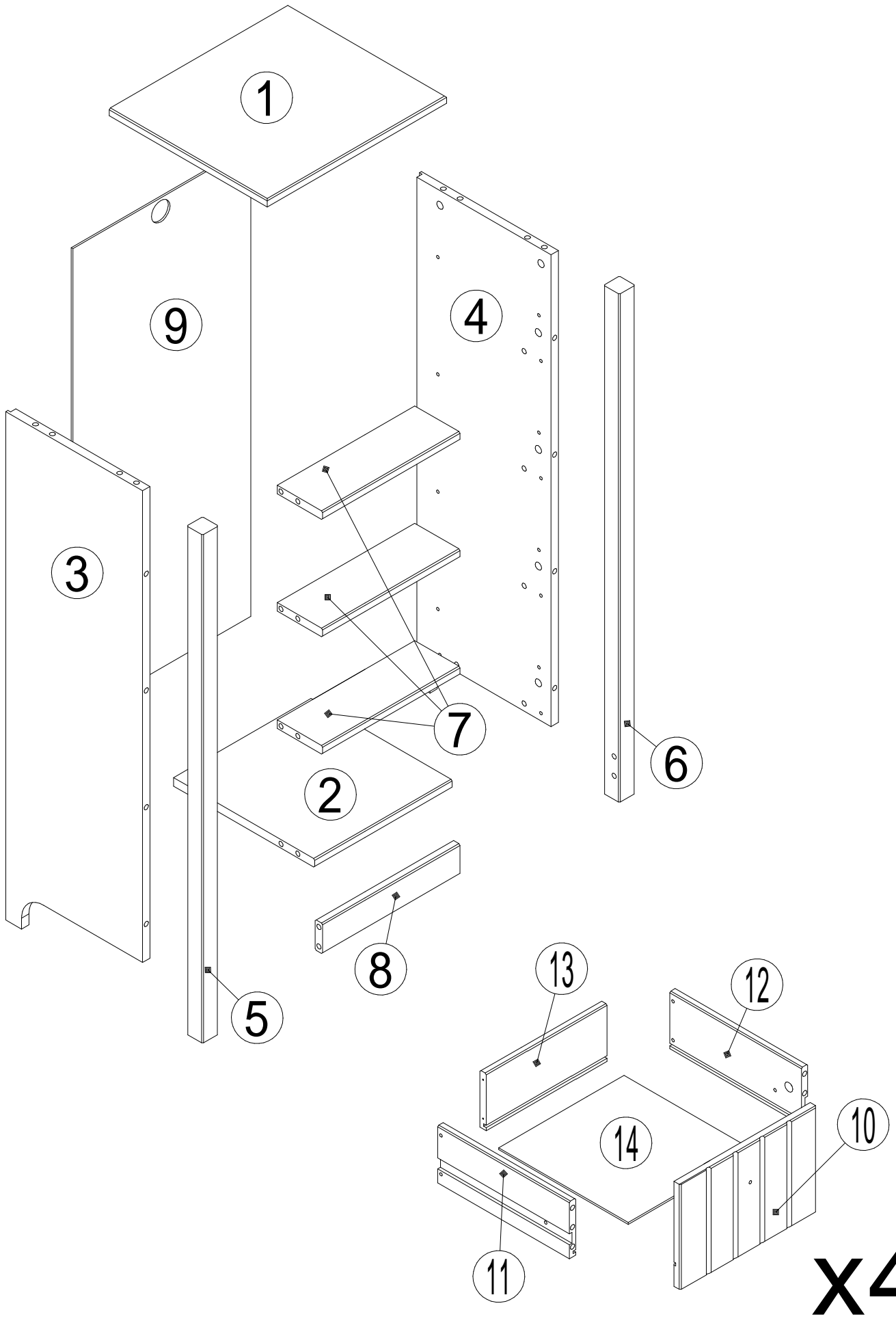

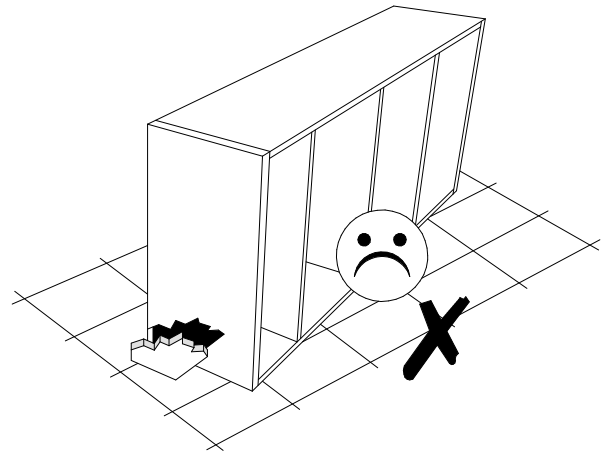
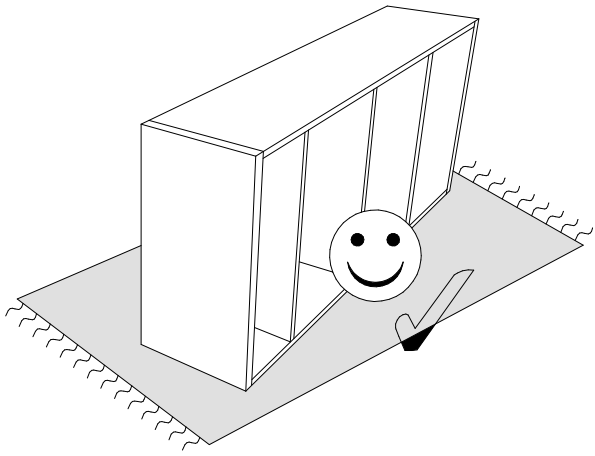

1

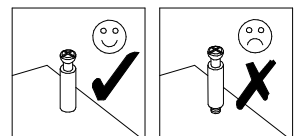
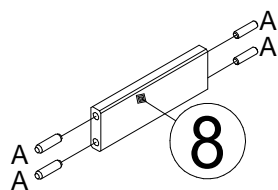
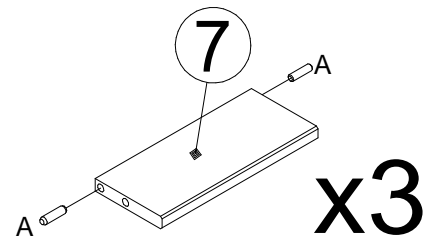
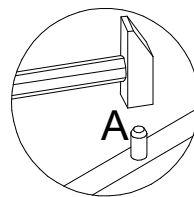
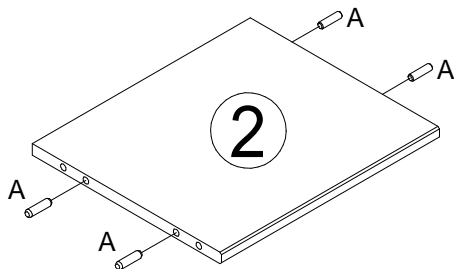
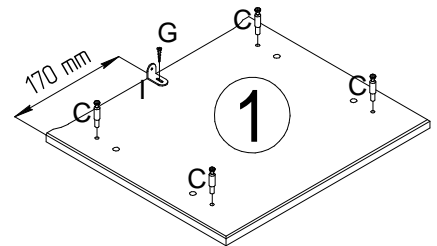
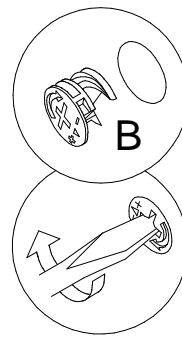
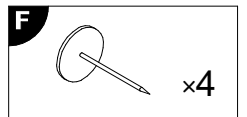
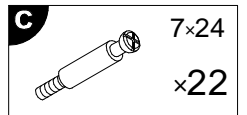
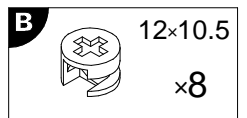
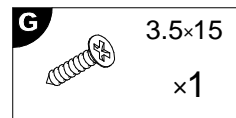
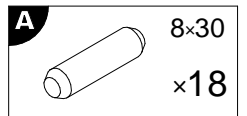
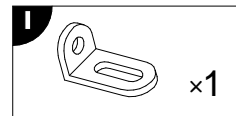
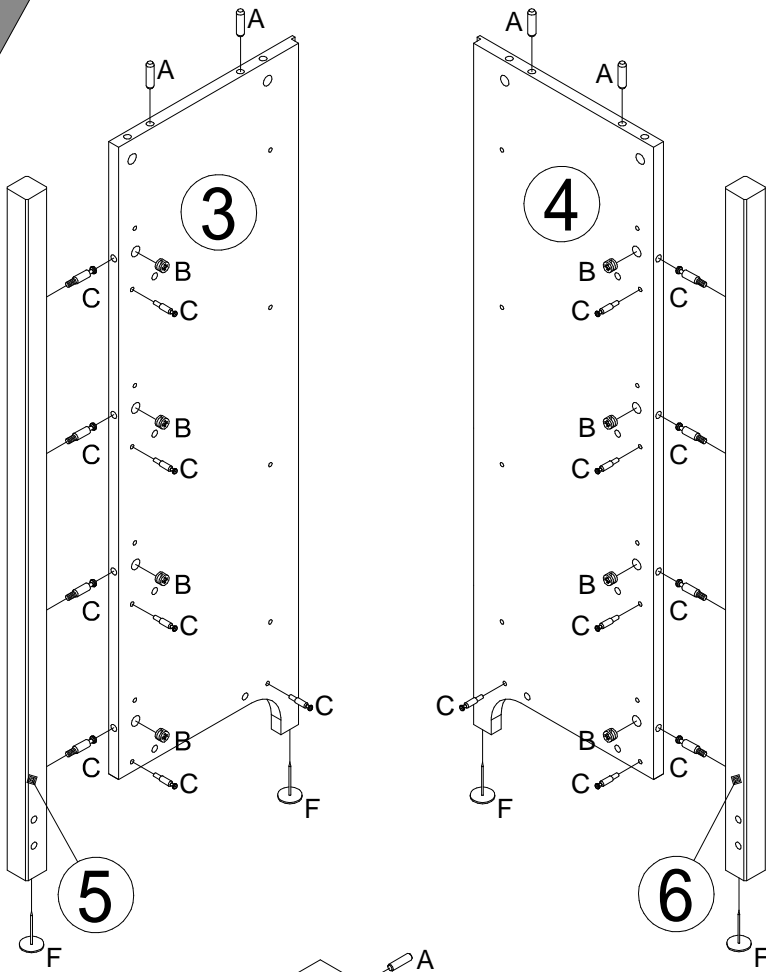

2

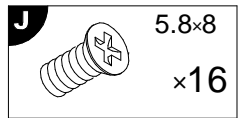
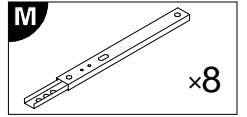
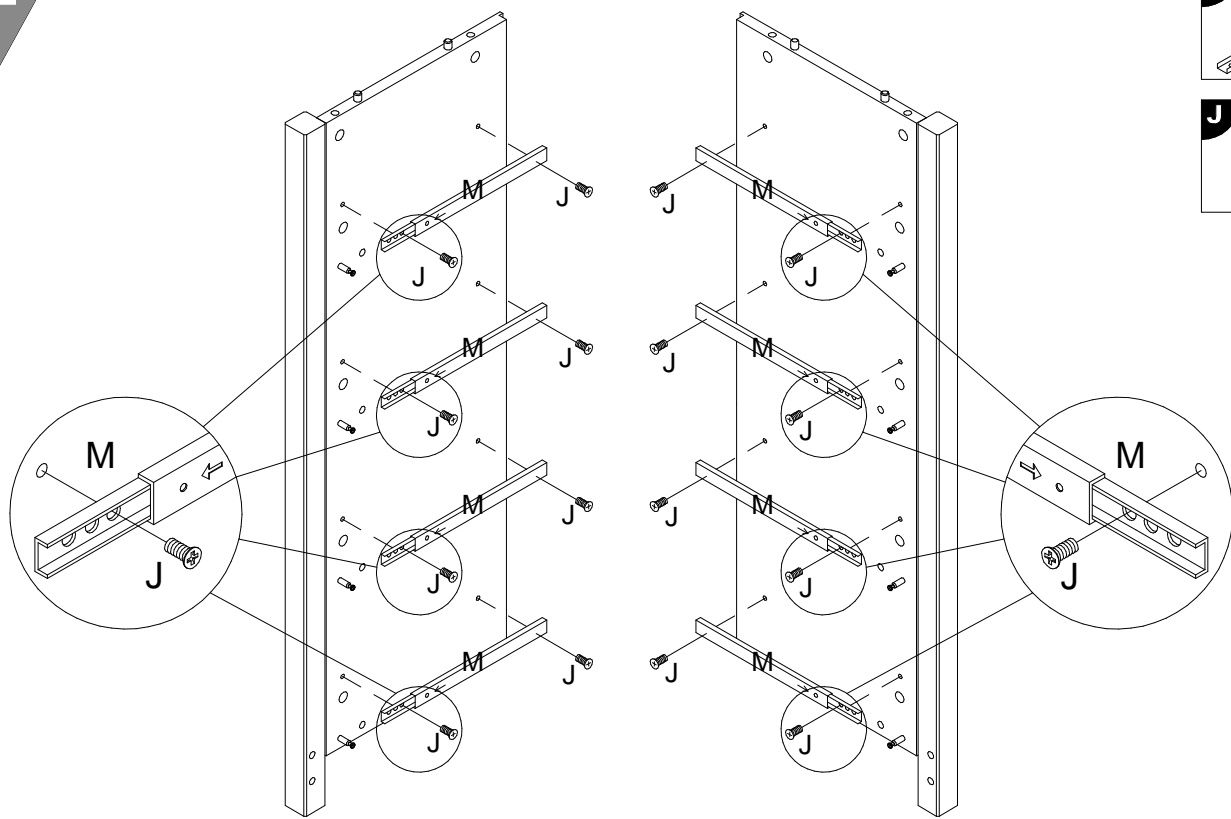

3

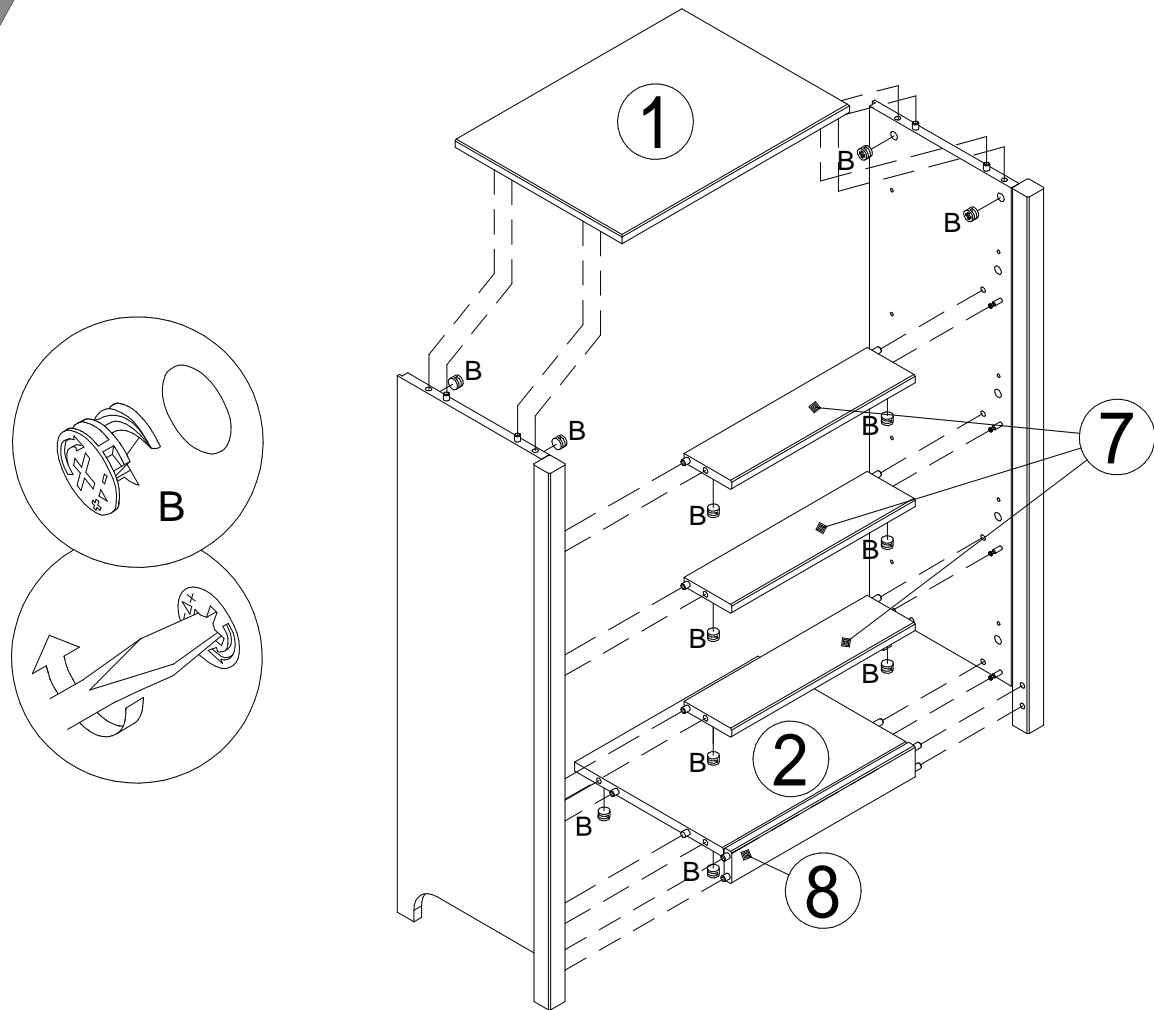

4

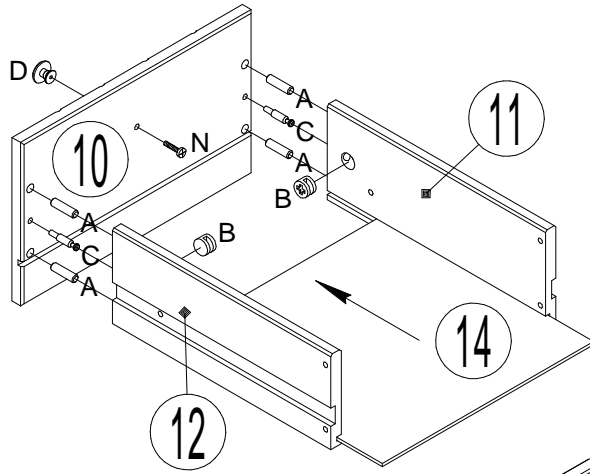

**x4**

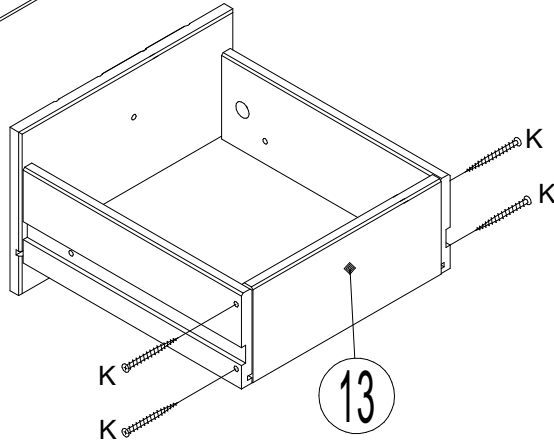
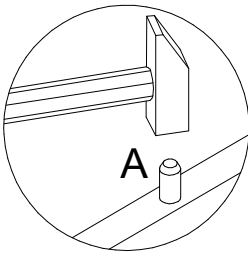

**A** 8x30  
x16

**B** 12x10.5  
x8

**C** 7x24  
x8

**D** x4

**K** 3.5x35  
x16

**N** M4x18  
x4

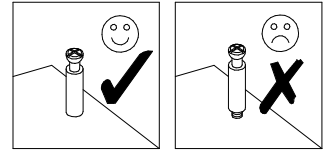

5

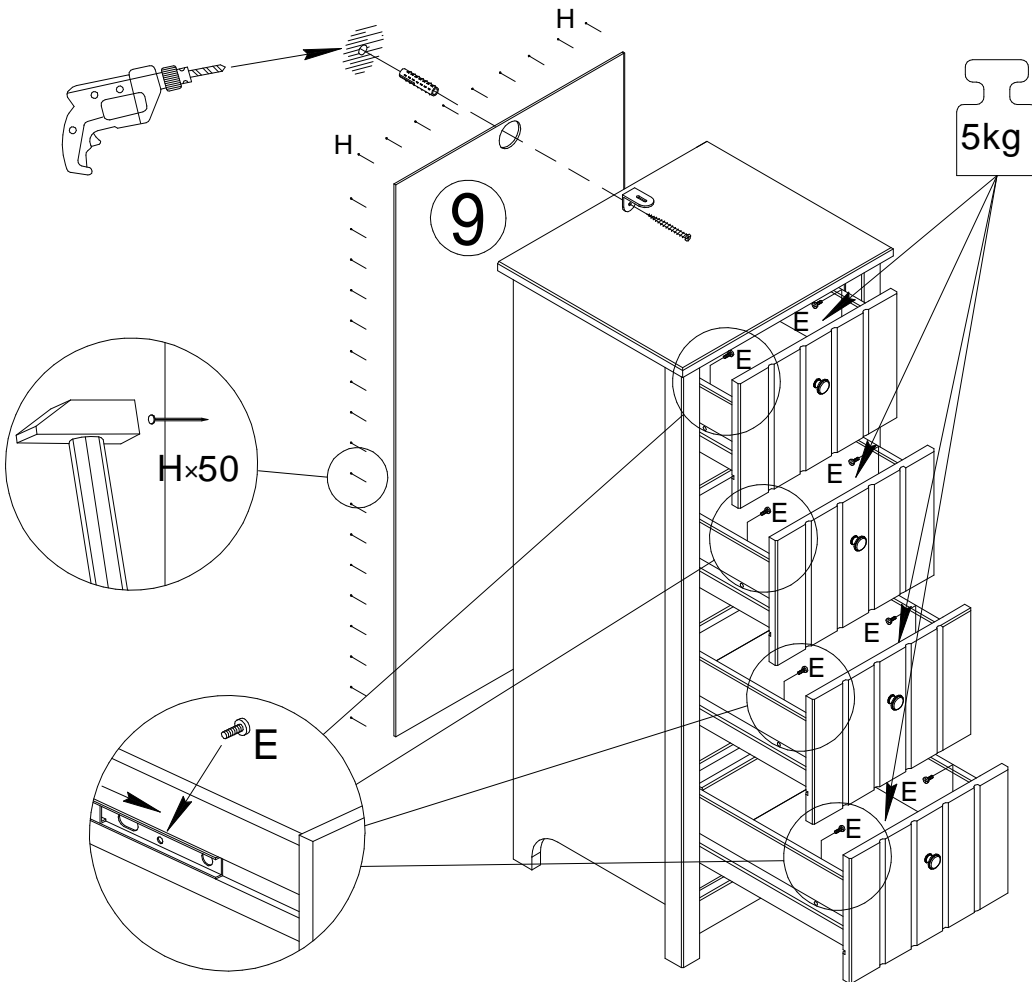

**H** x50

**E** M4x9  
x8

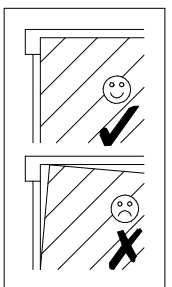
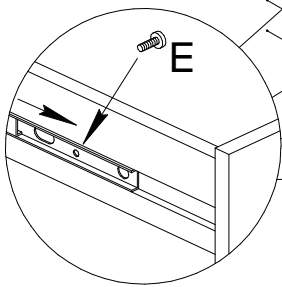
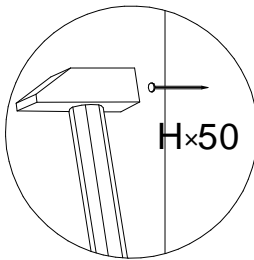

6



**Achtung • Attention • Attenzione  
Opgelet • Uwaga • Pozor • Figyelem  
Atenție • Dikkat • Внимание**



<b>(D)</b>	Wandbefestigung dient als Kippschutz – unbedingt anbringen! Bei einigen Wandtypen kann ein Spezialdübel erforderlich sein!
<b>(GB)</b>	The wall fastening serves to prevent tipping – be absolutely sure to mount it! For certain wall types, a special wall plug may be necessary!
<b>(FR)</b>	La fixation murale sert de protection contre le basculement – à installer impérativement ! Pour certains types de murs il faut des chevilles spéciales !
<b>(IT)</b>	Il fissaggio alla parete serve da protezione anti-ribaltamento – attaccarla assolutamente! Per alcune strutture di parete può essere necessario un tassello speciale!
<b>(NL)</b>	Bevestiging aan de muur dient als kantelbescherming – zeker en vast bevestigen! Bij enkele muurtypes is een speciale plug misschien vereist!
<b>(PL)</b>	Mocowanie do ściany jest jednocześnie zabezpieczeniem przed przewróceniem – koniecznie zamontować! Do niektórych rodzajów ścian koniecznie zastosować specjalne kołki mocujące.
<b>(CZ)</b>	Montáž na stěnu slouží jako ochrana proti převrnutí – bezpodmínečně umístěte! U některých typů stěn může být zapotřebí speciální hmoždinka!
<b>(SK)</b>	Upevnenie na stenu slúži ako ochrana proti prevráteniu – bezpodmienečne použite! Pre niektoré druhy stien môže byť potrebná špeciálna hmoždinka!
<b>(HU)</b>	A terméket a falhoz kel rögzíténi, különben az felborulhat! Egyes faltípusoknál speciális tiplit kell használni!
<b>(RO)</b>	Sistemul de fixare la perete servește ca protecție la răsturnare – de montat obligatoriu! Pentru unele tipuri de pereți este posibil să fie necesar un diblu special!
<b>(TR)</b>	Duvardaki sabitleme, devrilmeye karşı bir emniyet tedbiridir ve mutlaka monte edilmelidir! Bazı duvar tiplerinde bunun için özel bir dübel gerekli olabilir!
<b>(RU)</b>	Обязательно установите крепление на стене во избежание опрокидывания! Для некоторых типов стен может потребоваться специальный дюбель!