

- | | | | |
|-----------|------------------------------------|-----------|--------------------------------|
| D | Montageanleitung | GB | Assembly instructions |
| FR | Notice de montage | IT | Istruzioni di montaggio |
| NL | Handleiding voor de montage | PL | Instrukcja montażu |
| CZ | Montážní návod | SK | Návod na montáž |
| HU | Szerelési útmutató | RO | Instrucțiuni de montaj |
| TR | Montaj talimatı | RU | Инструкция по монтажу |

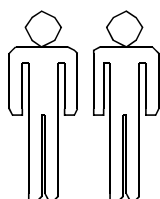

LKZ040779

Service . Assistenza . Dienstverlening . Serwis Servis . Szerviz

Name.Nom.Nome.Naam.
Nazwa.Jmeno.Nazov.Nev
Denumire.Isim

OLIVER

Nr. No. N. Homep. Č. Sz
25922455, 84953863, 61619655, 44166213, 10690938,
58294362

Typ . Type . Tip . Tipus . Tipo

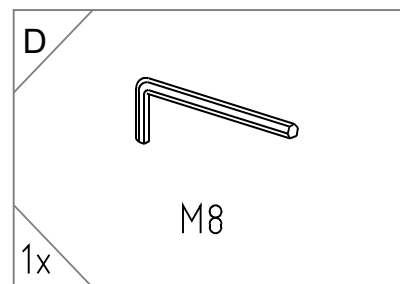
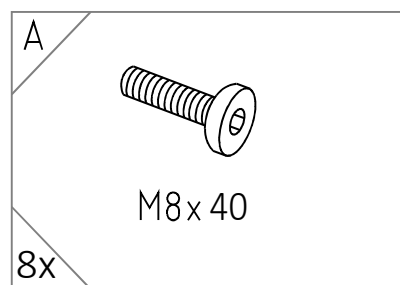
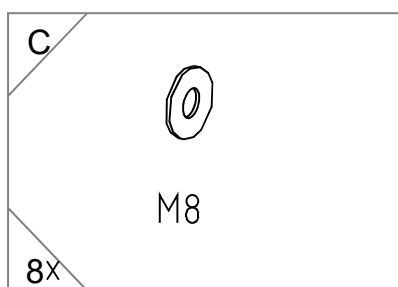
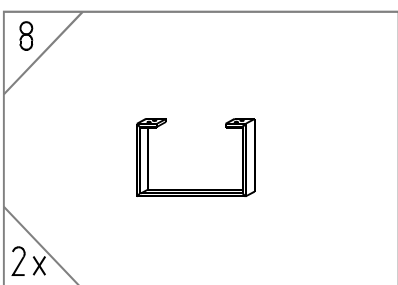
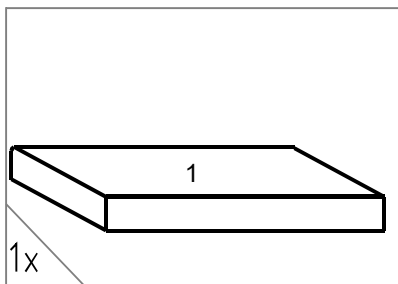
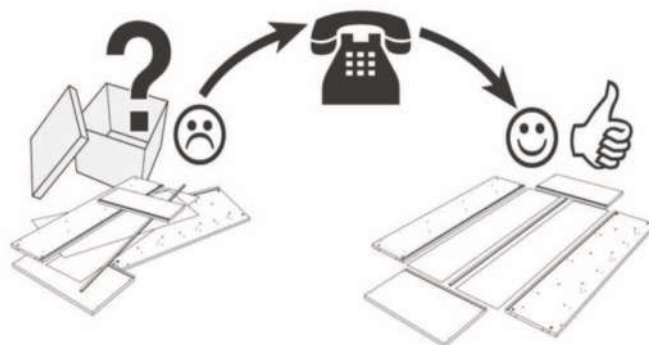
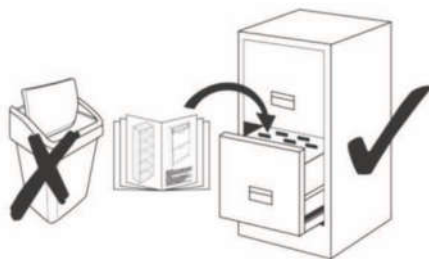

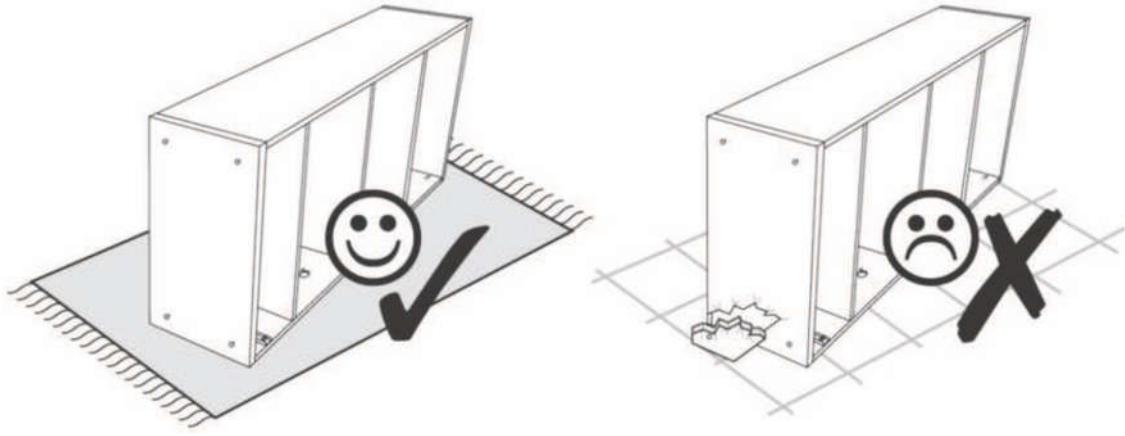

1

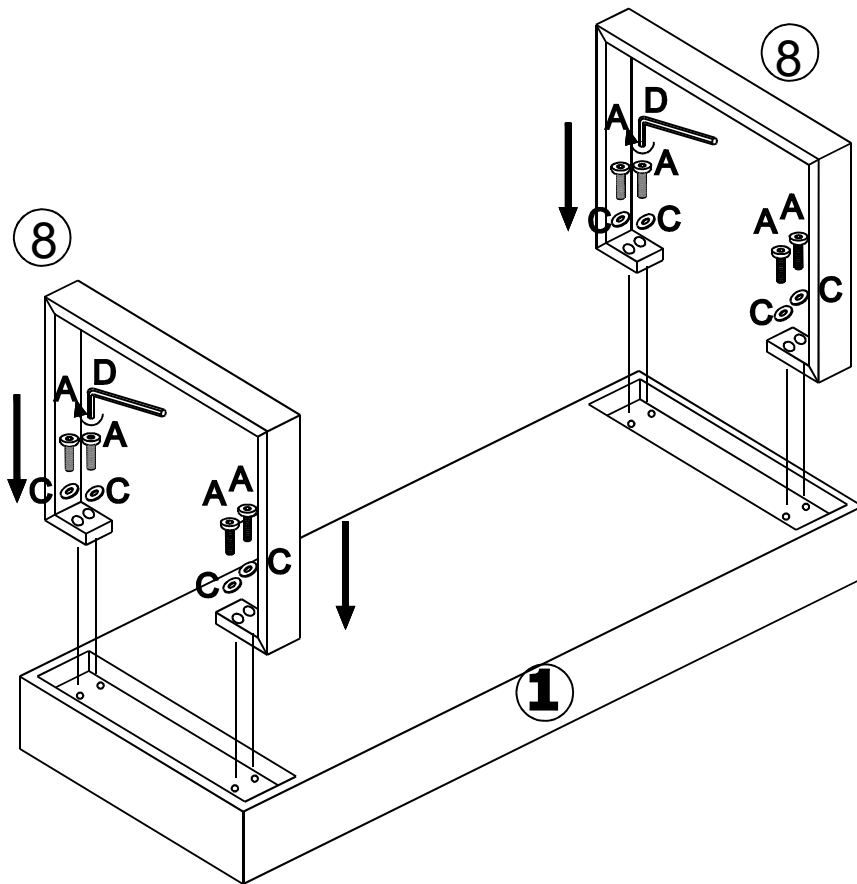

- | | | |
|---|--|----|
| 8 | | 1x |
| A | | 4x |
| C | | 4x |
| D | | 1x |
- M8x40
- M8
- M8

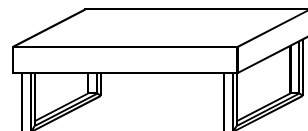



- D Allgemeiner Sicherheitshinweis:**
Nicht mehr benötigte Verpackungs-Materialien und Kleinteile von Kindern fernhalten!
- GB General safety instructions:**
Package material you do not need any more take far away from children.
- F Consigne de sécurité:**
Ecartez les matériaux d'emballage et petites pièces inutiles de la portée des enfants.
- PL Ogólne zasady bezpieczeñstwa:**
Nie potrzebne opakowania i małe części chronić przed dziećmi!
- RU Общие указания по безопасности:**
Неиспользуемые упаковочные материалы и мелкие детали следует хранить в недоступном для детей месте!
- NL Algemene veiligheidsinstructie:**
Verpakkingsmaterialen die u niet meer nodig heeft en kleine onderdelen uit de buurt van kinderen houden!
- TR Genel güvenlik uyarısı:**
Kullanılmayan ambalaj malzemeleri ve küçük parçaları çocuklardan uzak tutun!
- RO Indicație generală de siguranță:**
Ambalajele care nu mai sunt necesare și piesele de mici dimensiuni nu vor fi lăsate la îndemâna copiilor!
- IT Indicazioni generali per la sicurezza:**
Tenere lontano da bambini materiali di imballaggio non più necessari e minuterie!
- SK Všeobecné bezpečnostné upozornenie:**
Nepotrebný ballací materiál a malé diely uchovávajúte mimo dosahu detí!
- CZ Všeobecné bezpečnostní upozornění:**
Obalové materiály a malé díly, které už nepotřebujete, udržujte mimo dosah dětí!
- HU Általános biztonsági tudnivaló:**
Ha már nincs szükség a csomagolóanyagokra és apró darabokra, tegye őket olyan helyre, ahol nem férhetnek hozzá gyermekek!