

**OPTI  
FIT**®

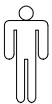

JAKA-BKL GmbH  
Jaka Straße 3  
D-32351 Stemwede-Wehden



3x 4x 5x

4x



Ø5/Ø8



Nr.157

Nr.102

# Montage

710 711 712

713 714

715 716

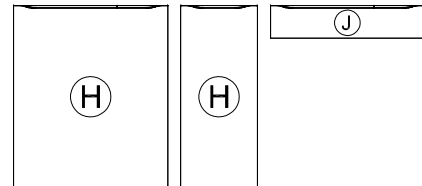
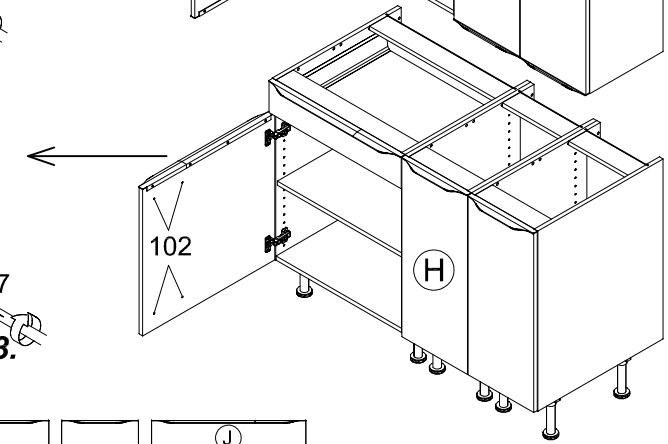
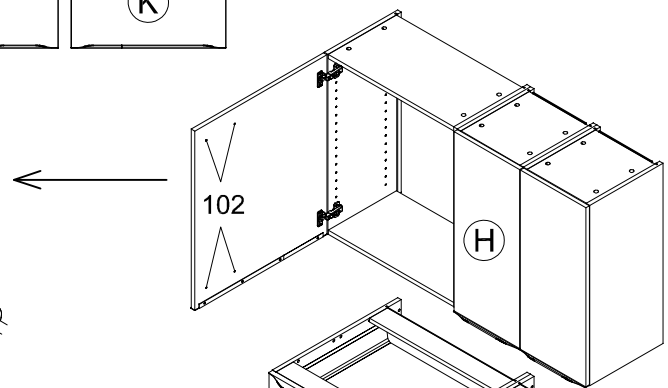
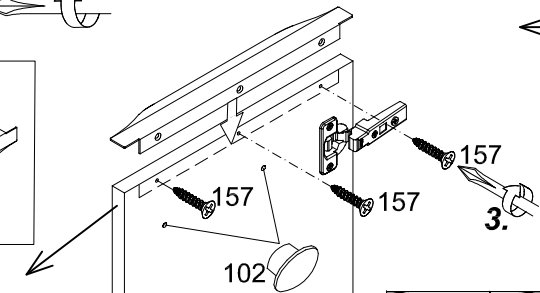
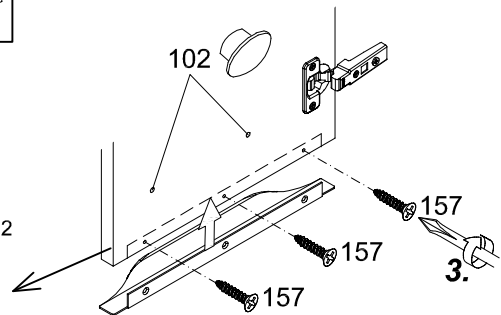
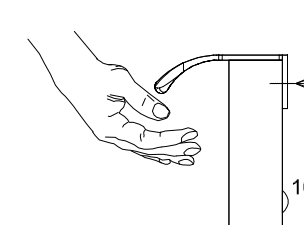
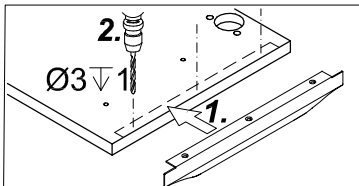
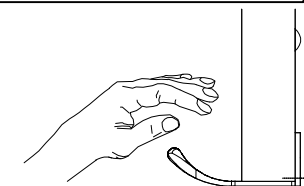
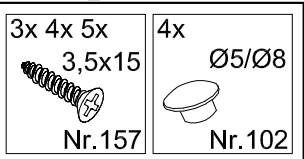
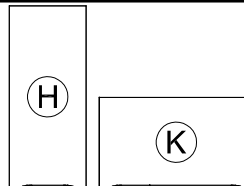
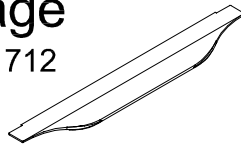

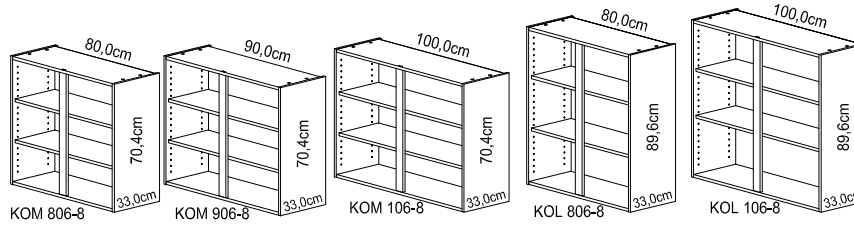
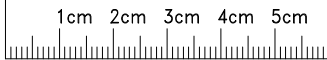

# Montageanleitung

1 → 2 → 3 ...

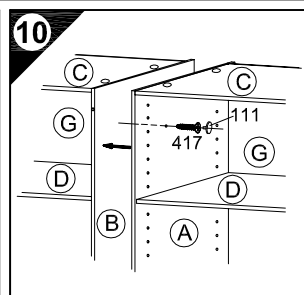
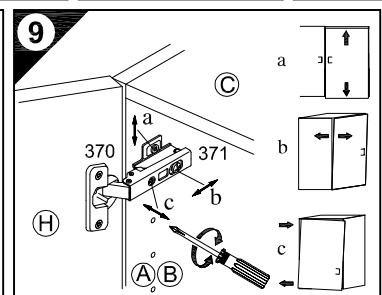
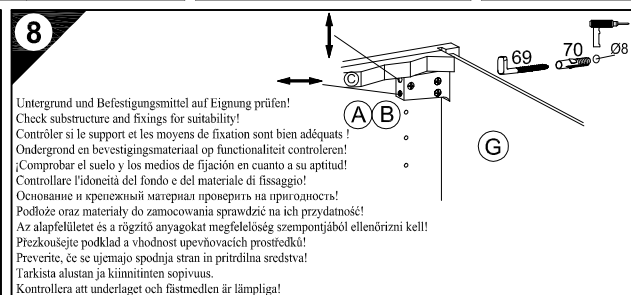
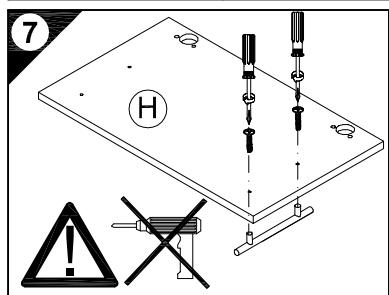
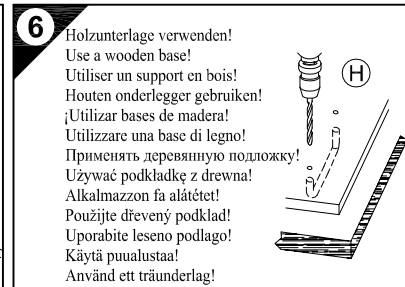
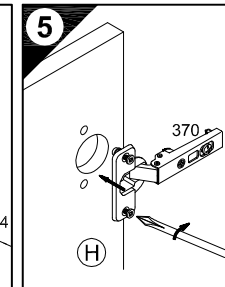
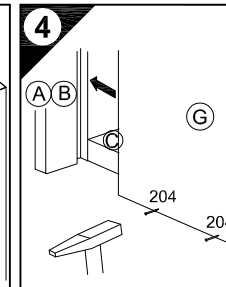
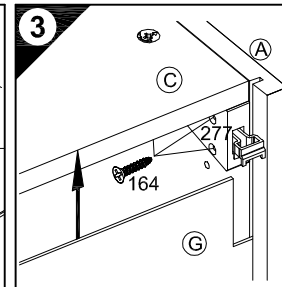
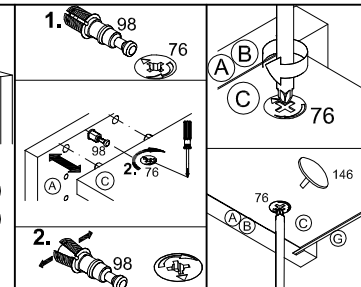
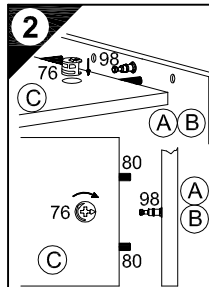
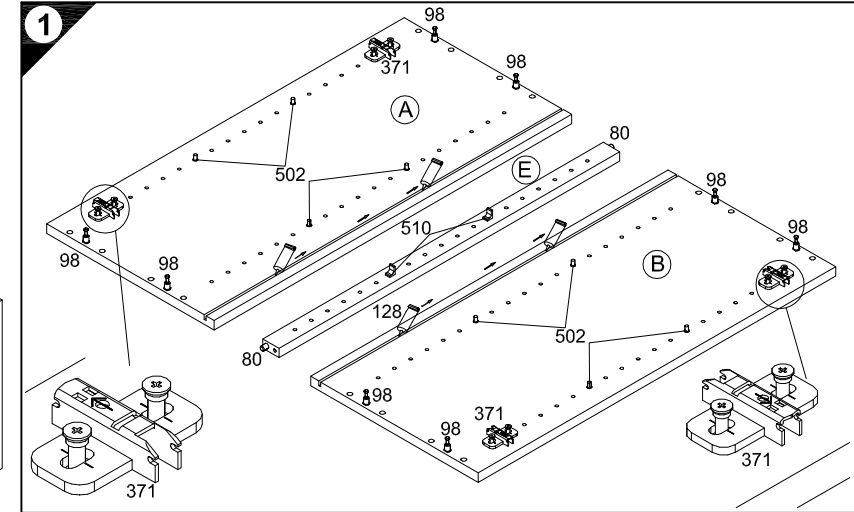
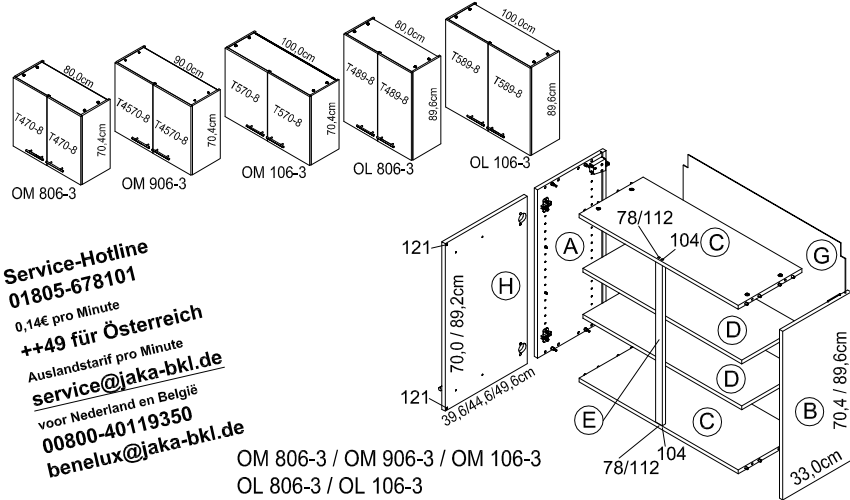
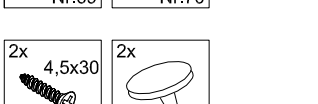
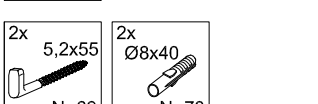
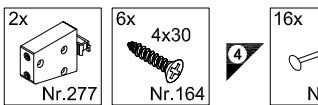
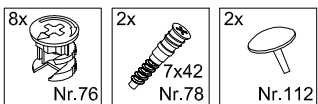
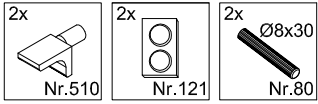
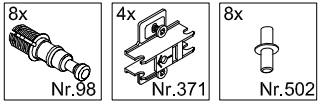

Ersatzteile/Spare parts/pièces de rechange/Reserveonderdelen/Piezas de recambio/Ricambi/Запасные части/Części zamiennepótalkatrészek/Náhradní části/Nadomestni deli/varaosat/reservdelar

80cm OM 806-3	(A) E940037	(B) E940037	(C) E941232	(D) E940332	(E) E940099	(G) E970011	(H) E940623
90cm OM 906-3	(A) E940037	(B) E940037	(C) E942239	(D) E941338	(E) E940099	(G) E970030	(H) E940620
100cm OM 106-3	(A) E940037	(B) E940037	(C) E942231	(D) E941331	(E) E940099	(G) E970026	(H) E940622
80cm OL 806-3	(A) E940044	(B) E940044	(C) E941232	(D) E940332	(E) E940094	(G) E970135	(H) E940529
100cm OL 106-3	(A) E940044	(B) E940044	(C) E942231	(D) E941331	(E) E940094	(G) E970136	(H) E940686

# SERVICEKARTE

VH

Liebe Kundin, lieber Kunde,

obwohl wir unsere Möbel vor der Auslieferung einer eingehenden Endkontrolle unterziehen, kann es vorkommen, dass einmal ein Zubehörteil fehlt oder während des Transports beschädigt wird. Senden sie den Artikel bitte nicht zurück, sondern fordern sie einfach Ersatz für das Einzelteil bei unserer Kundenhotline an. Die Telefonnummern finden sie auf den Serviceseiten im Katalog.

Bitte benennen sie die Teile wie sie auf ihrer Aufbauanleitung angegeben sind. Fügen sie auch **Artikelnummer, Modellnamen und Farbnummer** bei. **Siehe Beispiel.**

Wir werden ihre Anforderung sofort bearbeiten und ihnen das Ersatzteil umgehend zusenden.

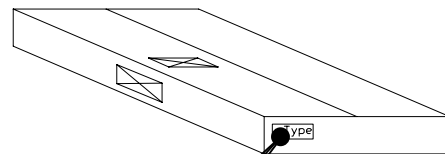
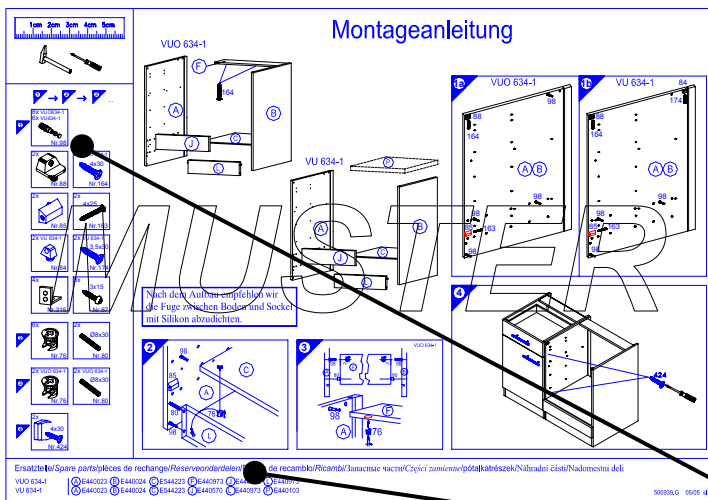

Muster - Bestellung		
Artikelnummer	123 456	
Modellname	Unterschrank VU634	
Farbe	TA 01	
Benötigte Ersatzteile:		
Bezeichnung	Nr.	Anzahl
Beschlagteil	98	2
Teil B	E 440 023	1

Bitte entnehmen sie die notwendige Ersatzteilnummer der Aufbauanleitung die zum Möbel gehört!

Kundendaten	
Kundennummer	
Name	
Vorname	
Strasse	
Haus-Nr.	
PLZ	
Ort	
Rechnungsdatum	
Tel. für Rückfragen	
Notizen:	

Ersatzteilbestellung		
Artikelnummer		
Modellname		
Farbe		
Benötigte Ersatzteile:		
Bezeichnung	Nr.	Anzahl
Grund der Ersatzteilanforderung:		