

VARIANT 1

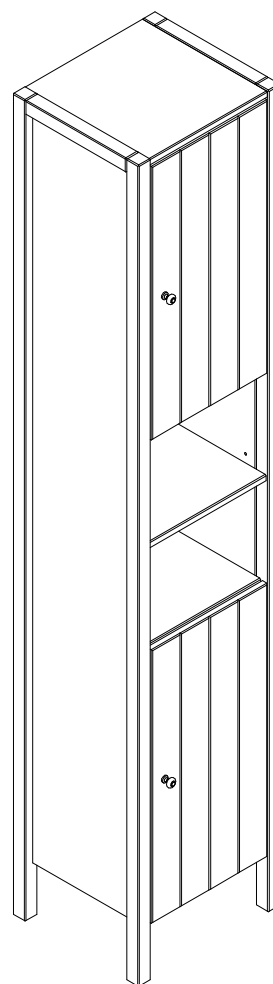

VARIANT 2



- | | | | |
|-----------|------------------------------------|-----------|--------------------------------|
| D | Montageanleitung | GB | Assembly instructions |
| FR | Notice de montage | IT | Istruzioni di montaggio |
| NL | Handleiding voor de montage | PL | Instrukcja montażu |
| CZ | Montážní návod | SK | Návod na montáž |
| HU | Szerelési útmutató | RO | Instrukțiuni de montaj |
| TR | Montaj talimatı | RU | Инструкция по монтажу |

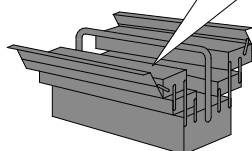
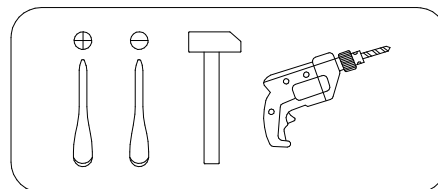
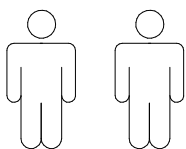

Service · Dienstverlening · Serwis · Servis · Сервисная служба

Name · Naam · Nazwa · Isim · Название

Nr. · No. · Номер

Typ · Type · Tip · Тип

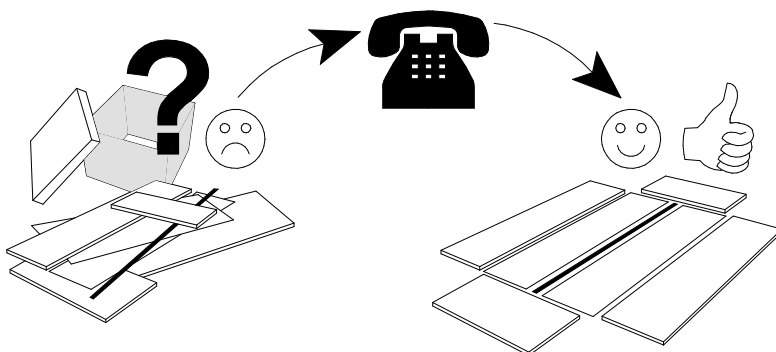
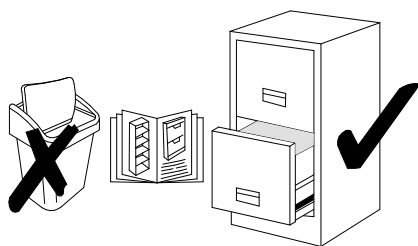



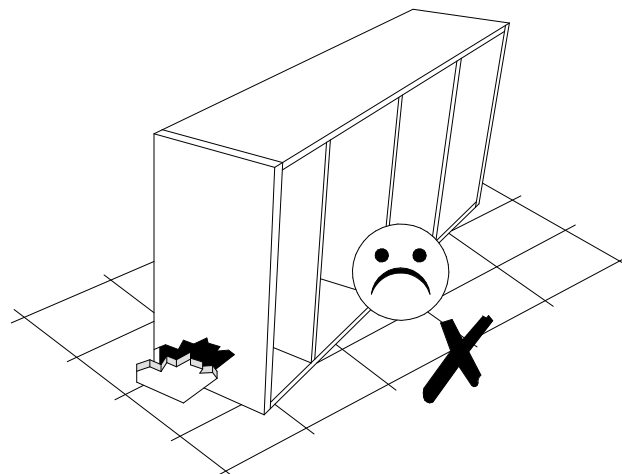
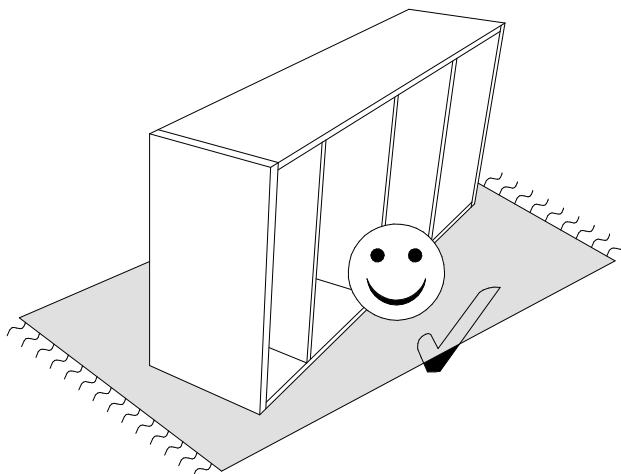
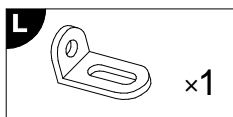
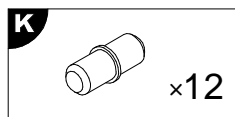
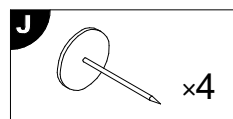
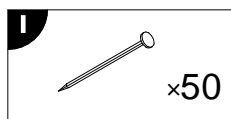
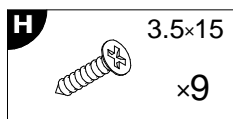
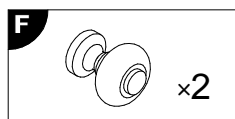
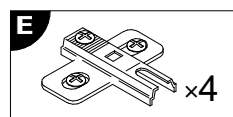
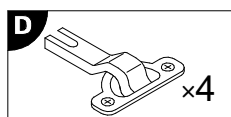
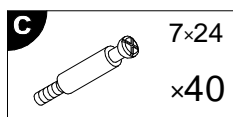
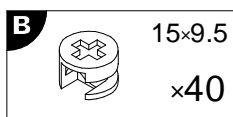
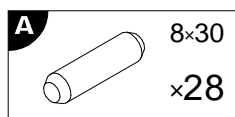

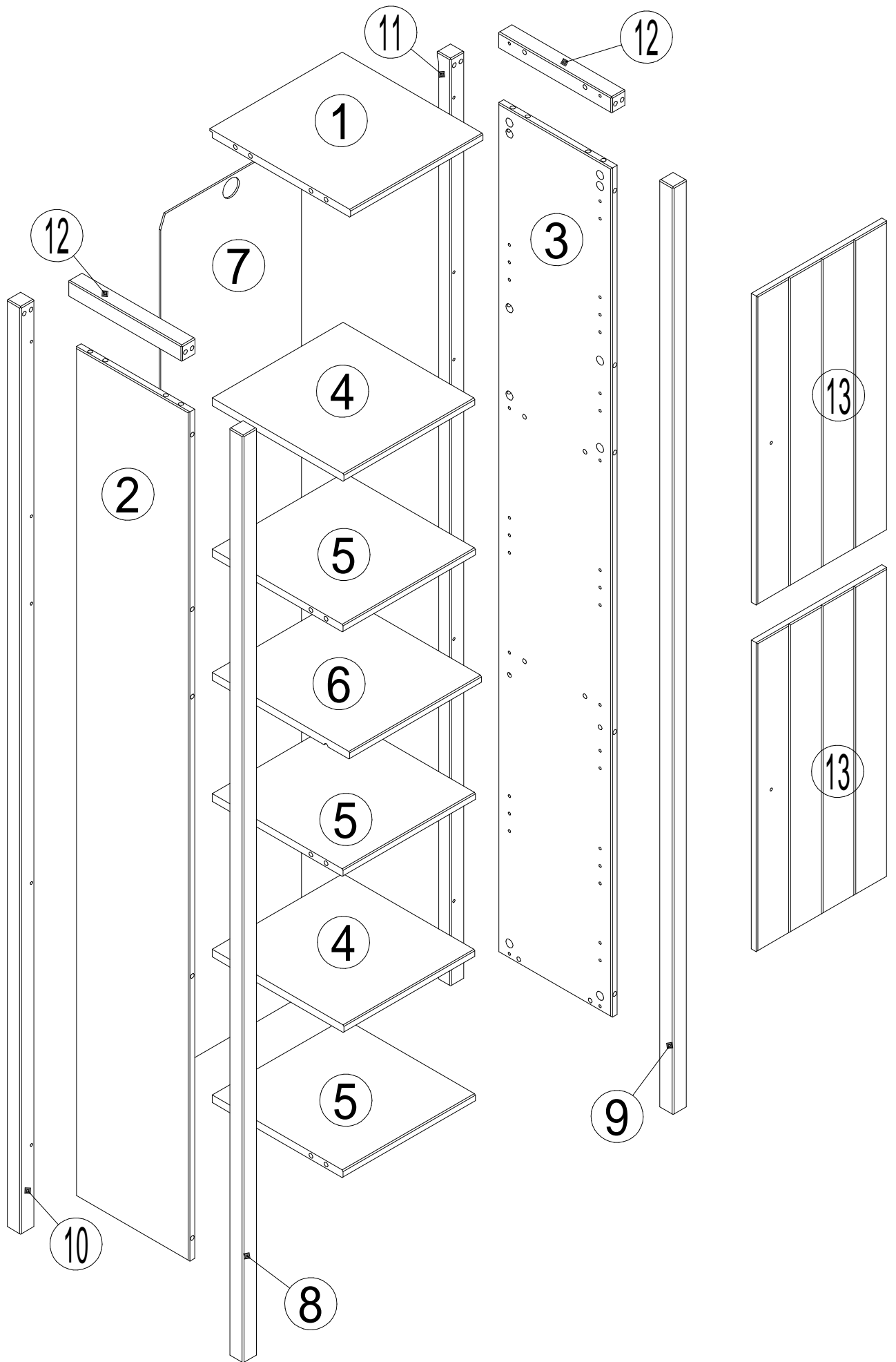
N	Size/MaB (mm)	Qty	✓	N	Size/MaB (mm)	Qty	✓
1	280×298	1		8	1700×30	1	
2	1556×240	1		9	1700×30	1	
3	1556×240	1		10	1700×30	1	
4	279×277	2		11	1700×30	1	
5	280×277	3		12	241×30	2	
6	279×291	1		13	566×276	2	
7	1577×298	1					



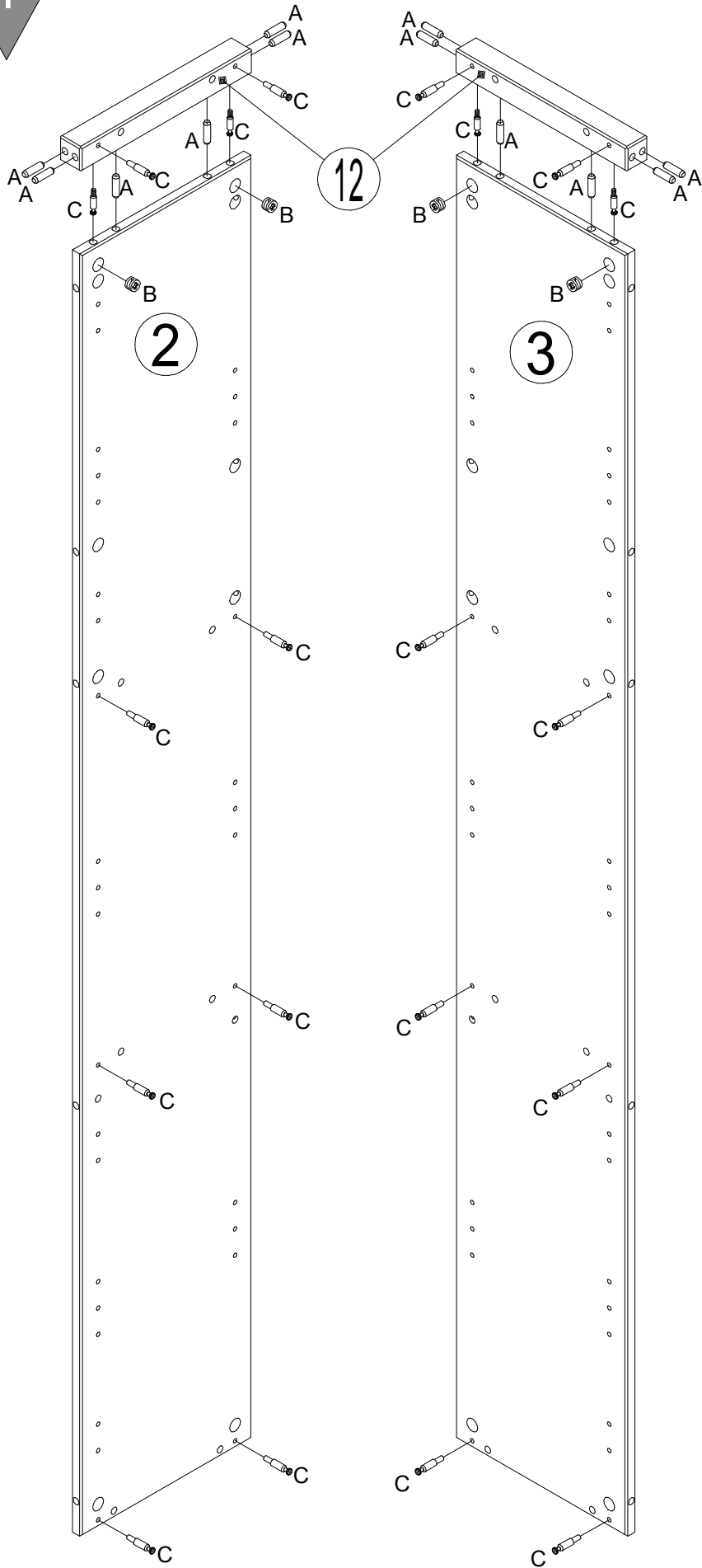

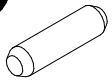

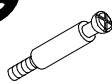
1

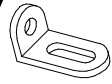

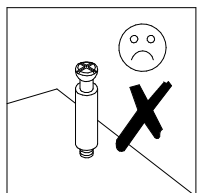
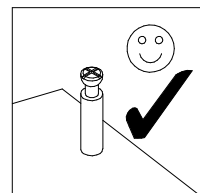
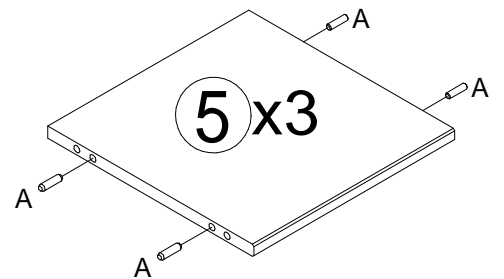
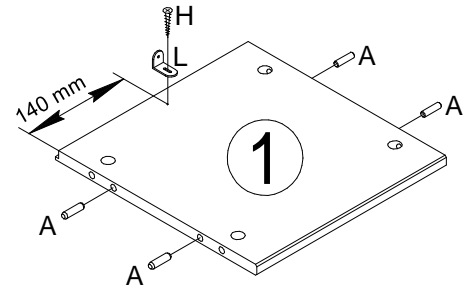
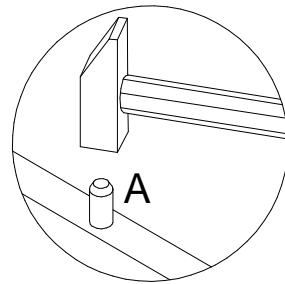
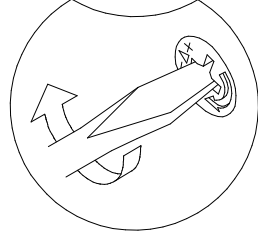
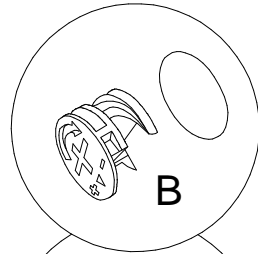
- A**  8x30
x28
- B**  15x9.5
x4
- C**  7x24
x20
- H**  3.5x15
x1
- L**  x1

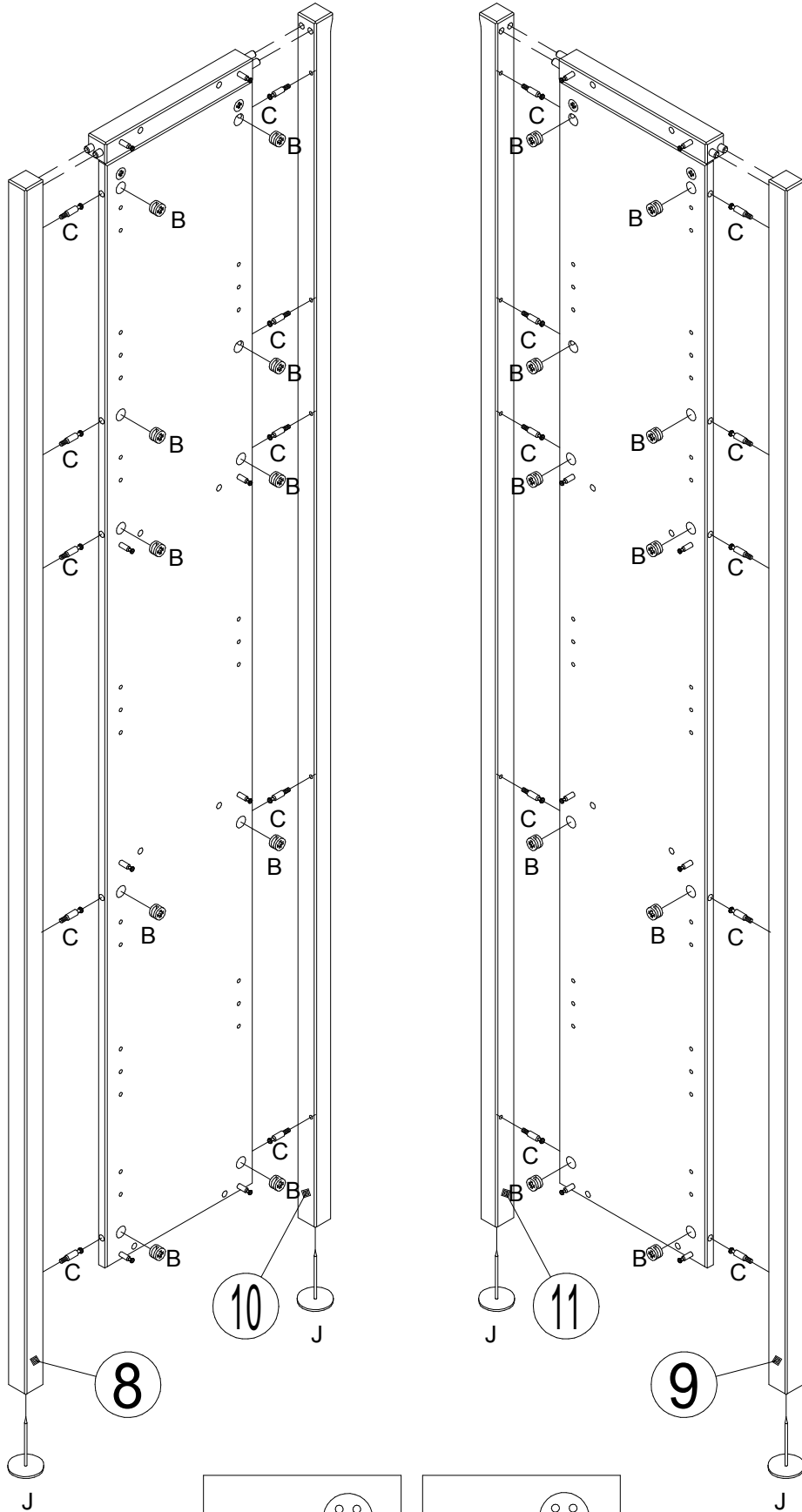

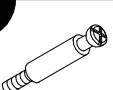
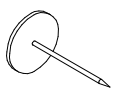

- B**  15x9.5
x20
- C**  7x24
x20
- J**  x4

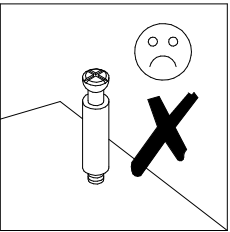
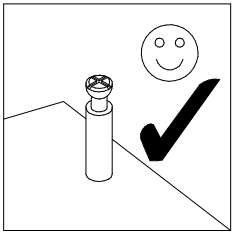
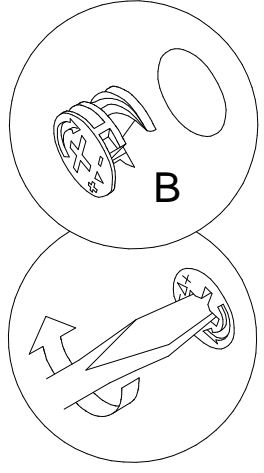

3

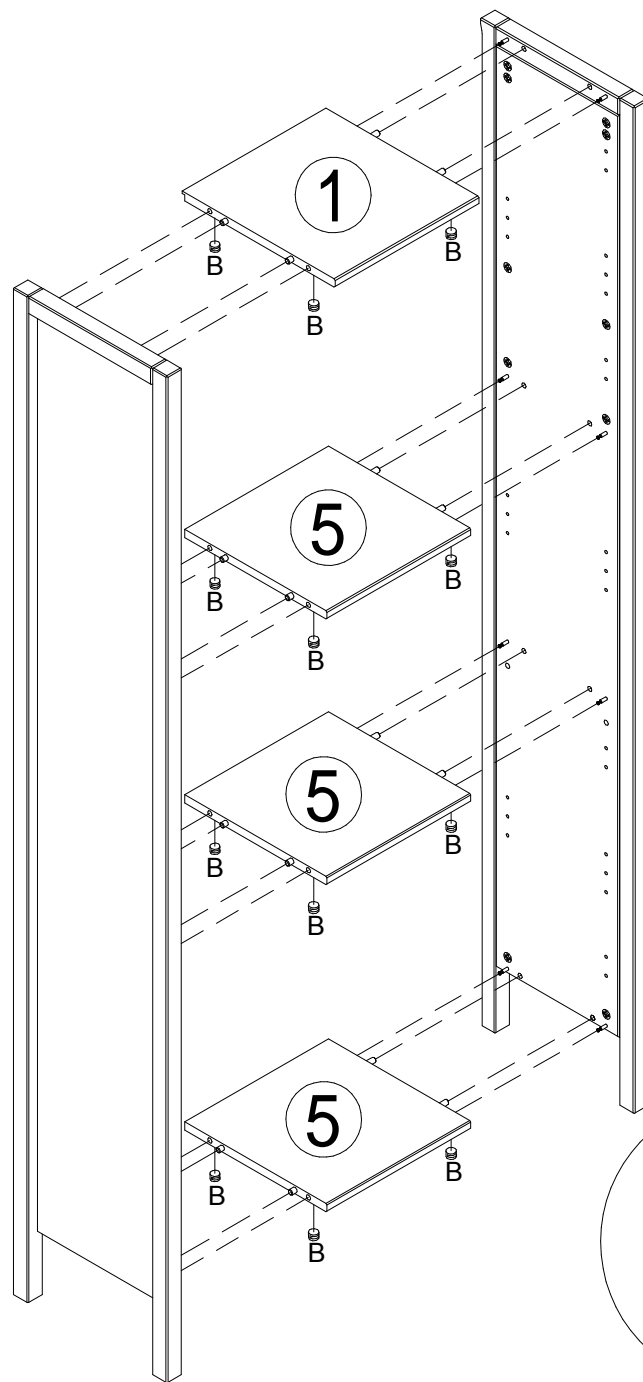

B 15x9.5
x16

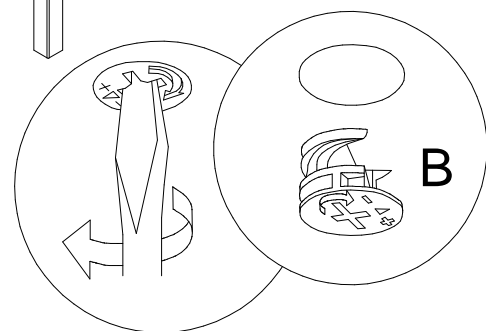

4

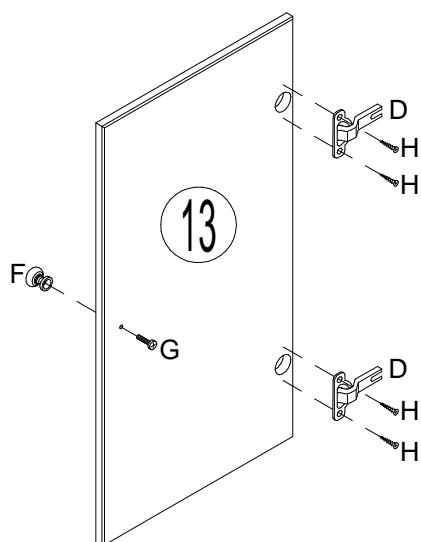

x2

D x4

F x2

H 3.5x15
x8

G M4x18
x2

5

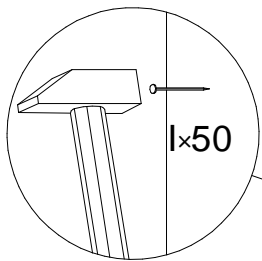
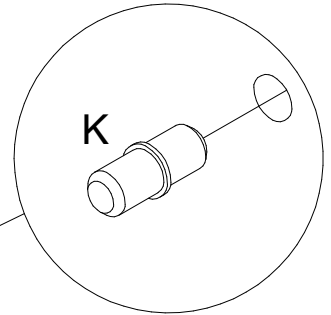
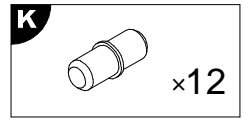
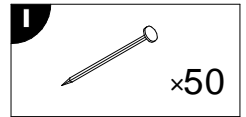
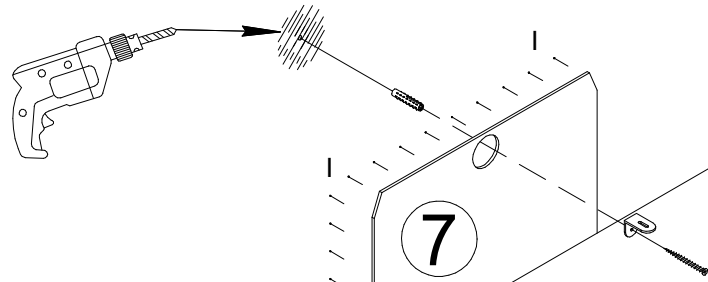

7

4

6

4

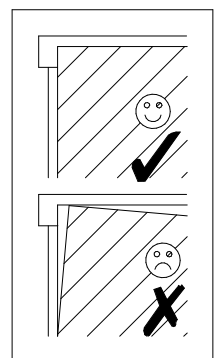

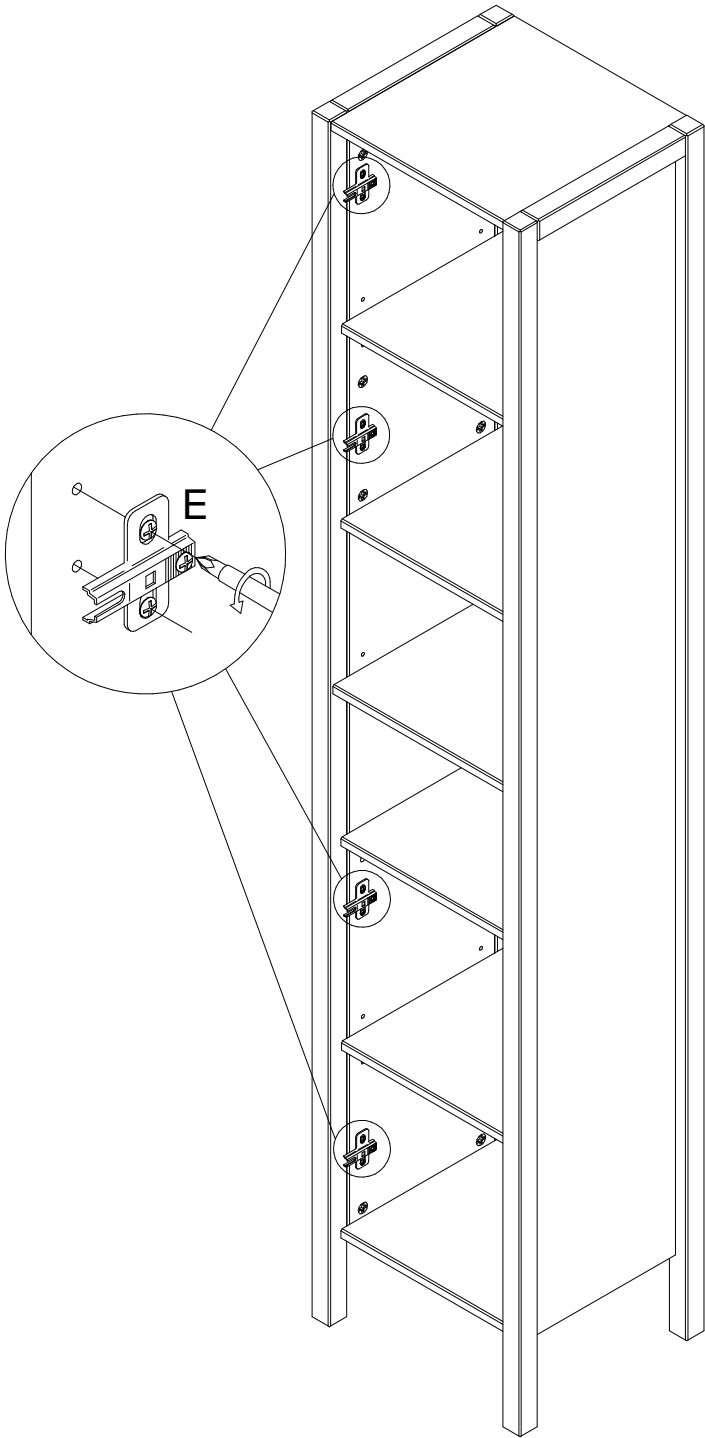
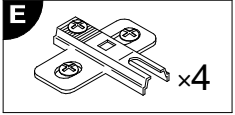

Variant 1

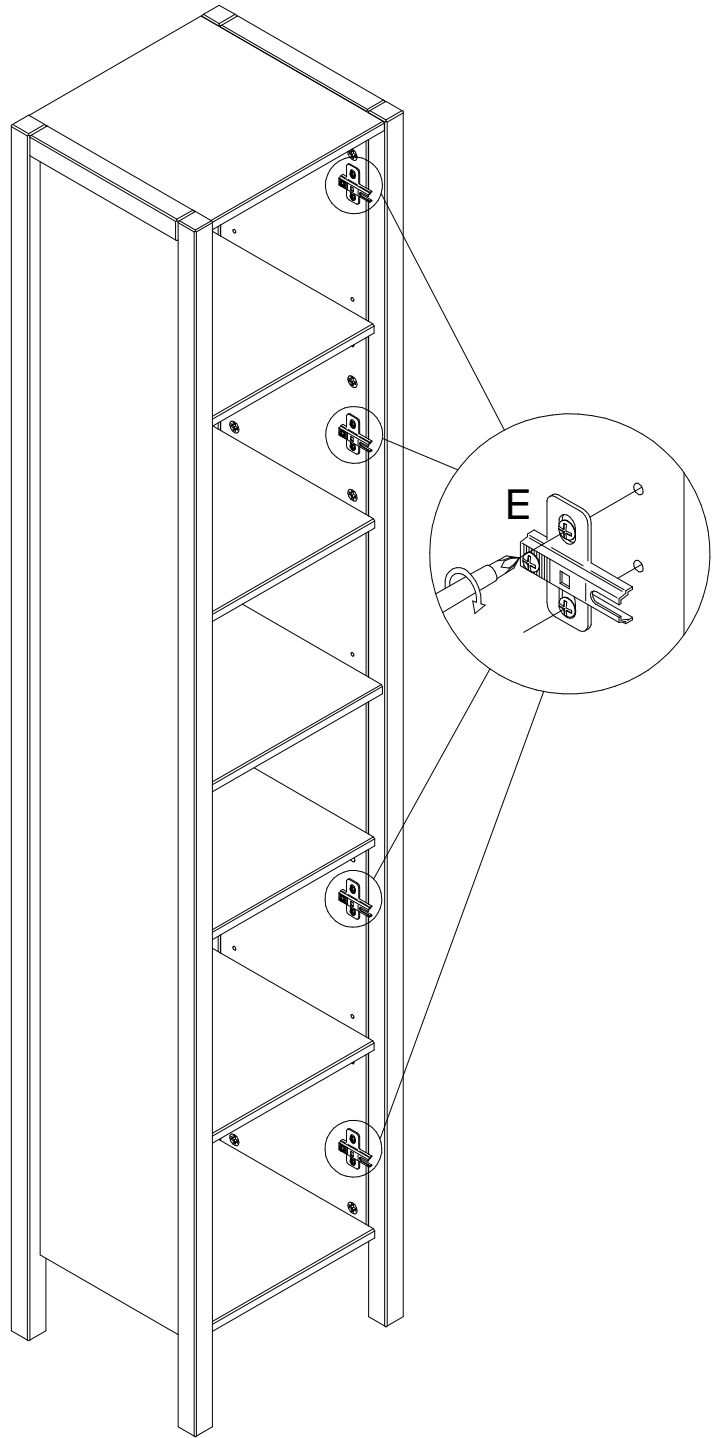

Variant 2

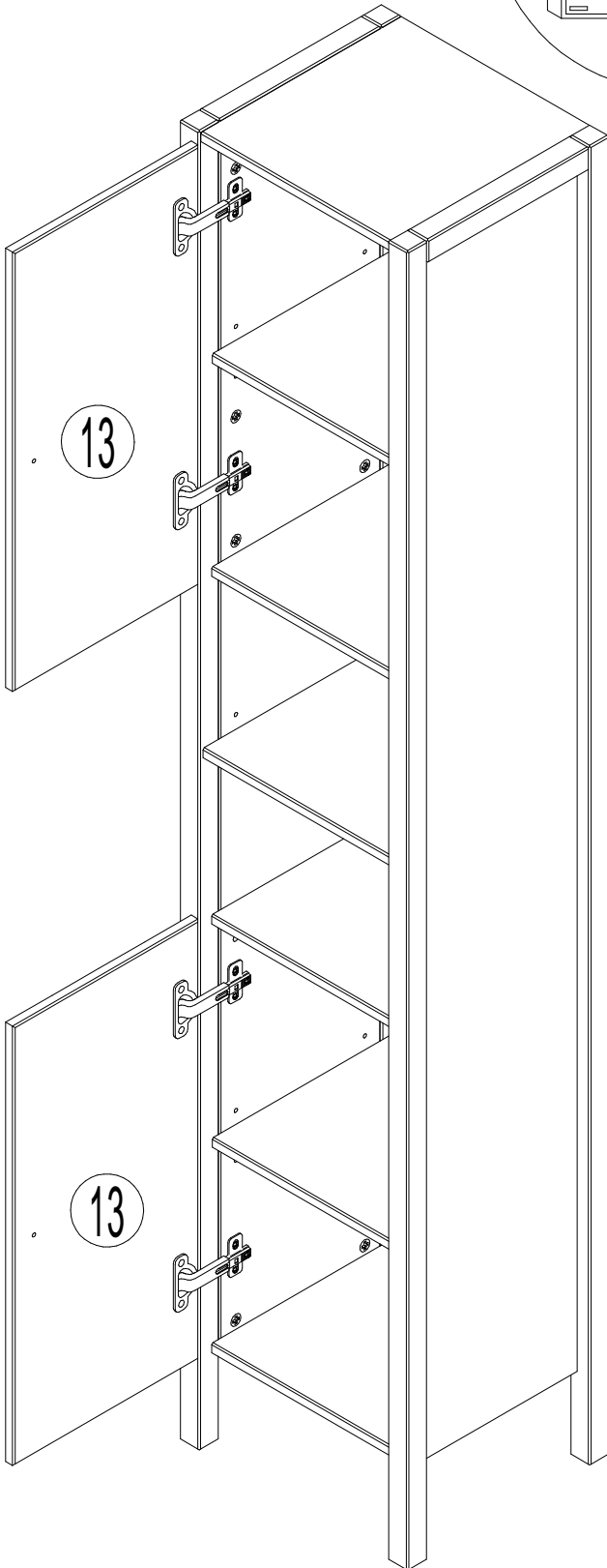
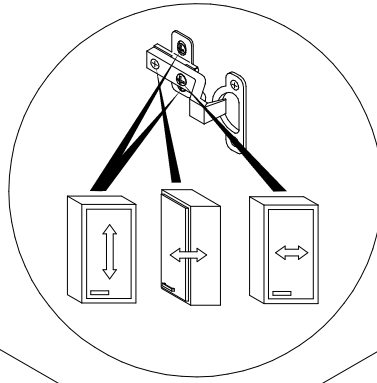

Variant 1

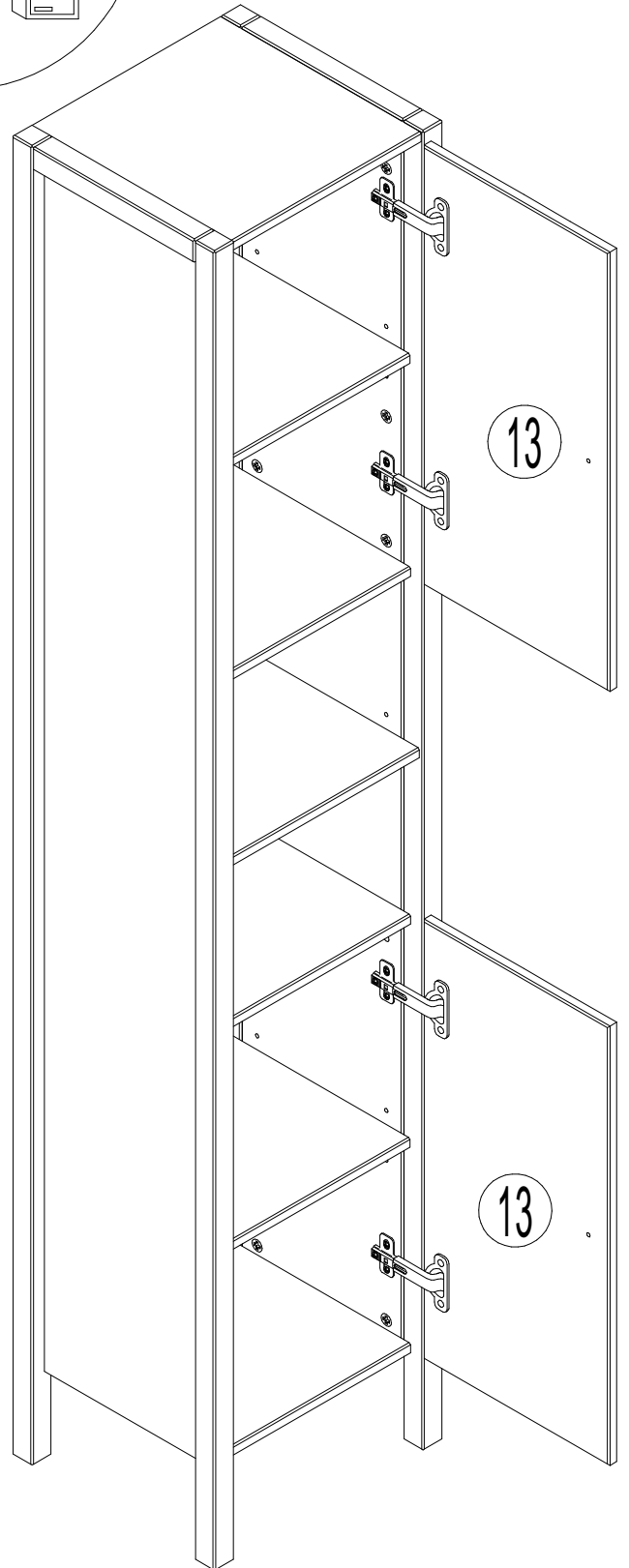

Variant 2