

# JOHN 2 CORD

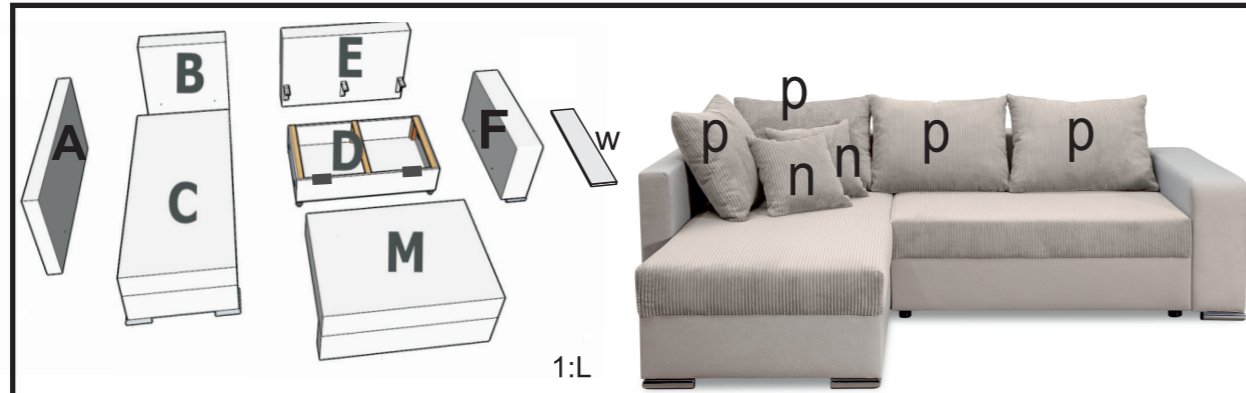

- |                                  |                                |
|----------------------------------|--------------------------------|
| (DE) Montageanleitung            | (IT) Istruzioni di montaggio   |
| (PL) Instrukcja montażu          | (FR) Notice de montage         |
| (NL) Handleiding voor de montage | (RO) Instrucțiuni de asamblare |
| (GB) Assembly instructions       | (SK) Montážny návod            |
| (TR) Montaj talimatı             | (CZ) Montážní návod            |
| (RU) Инструкция по монтажу       | (HU) Szerelési útmutató        |



4x (M8x60)	4x (M8x90)	8x	8x Ø8	8x	8x M8	9x (4x16)	8x (5x35)
	8x (M6x35)	1x	8x	4x	2x	4x	

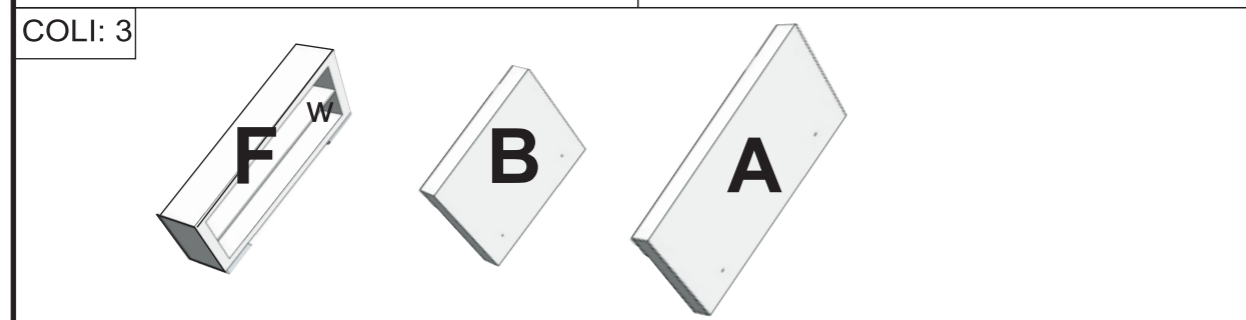
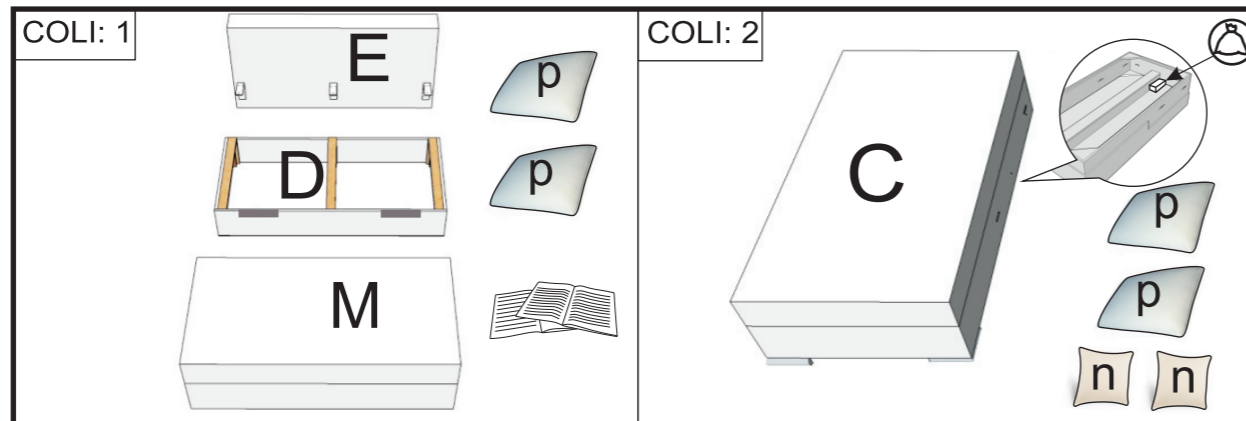

1 - John 2 - L

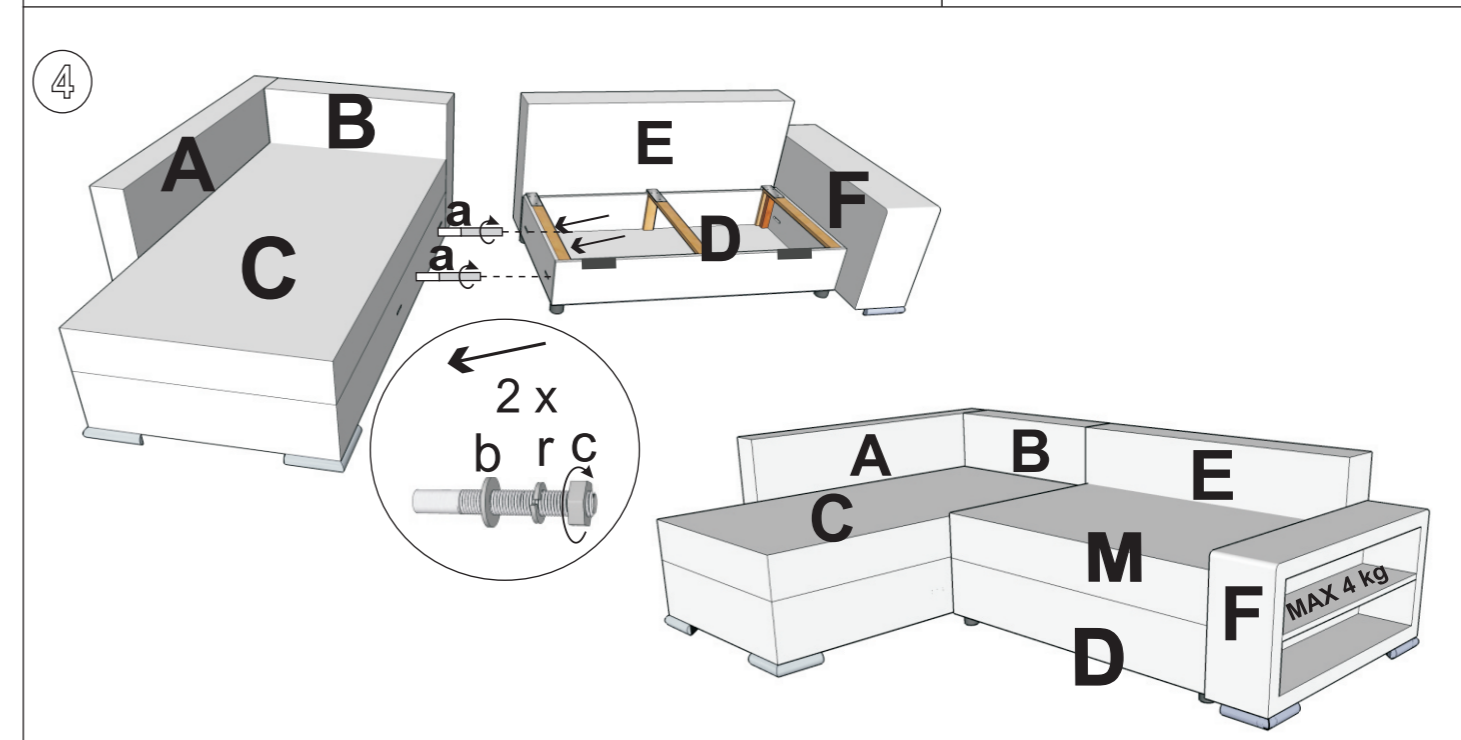
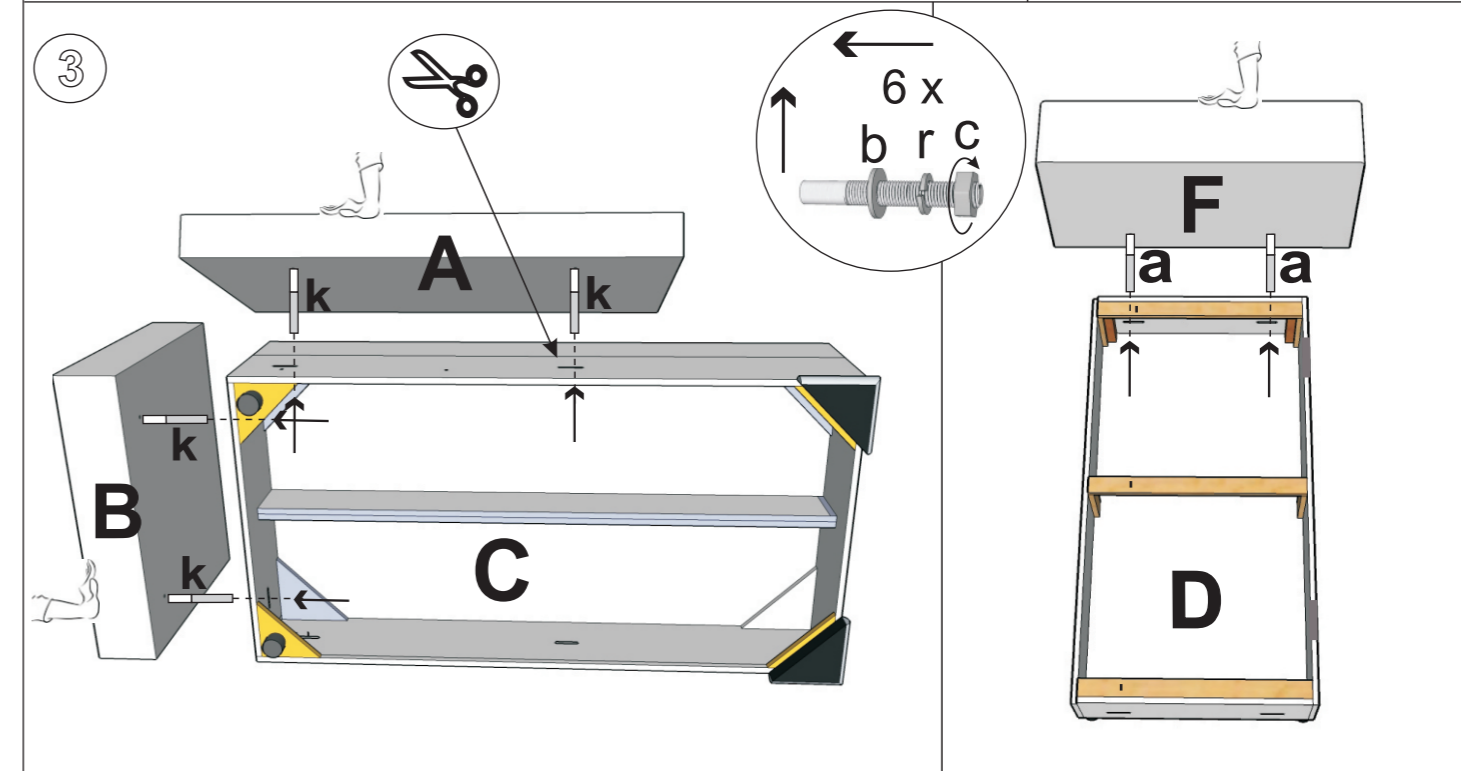
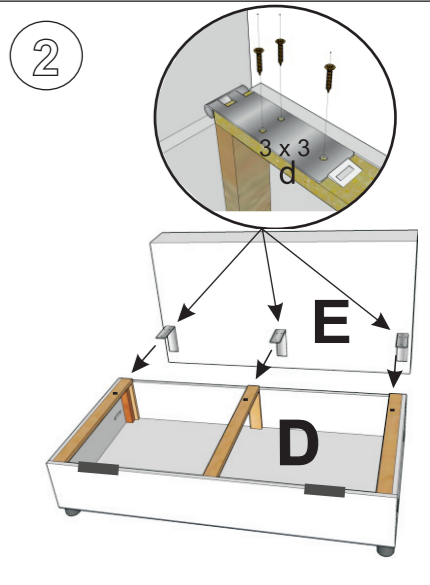
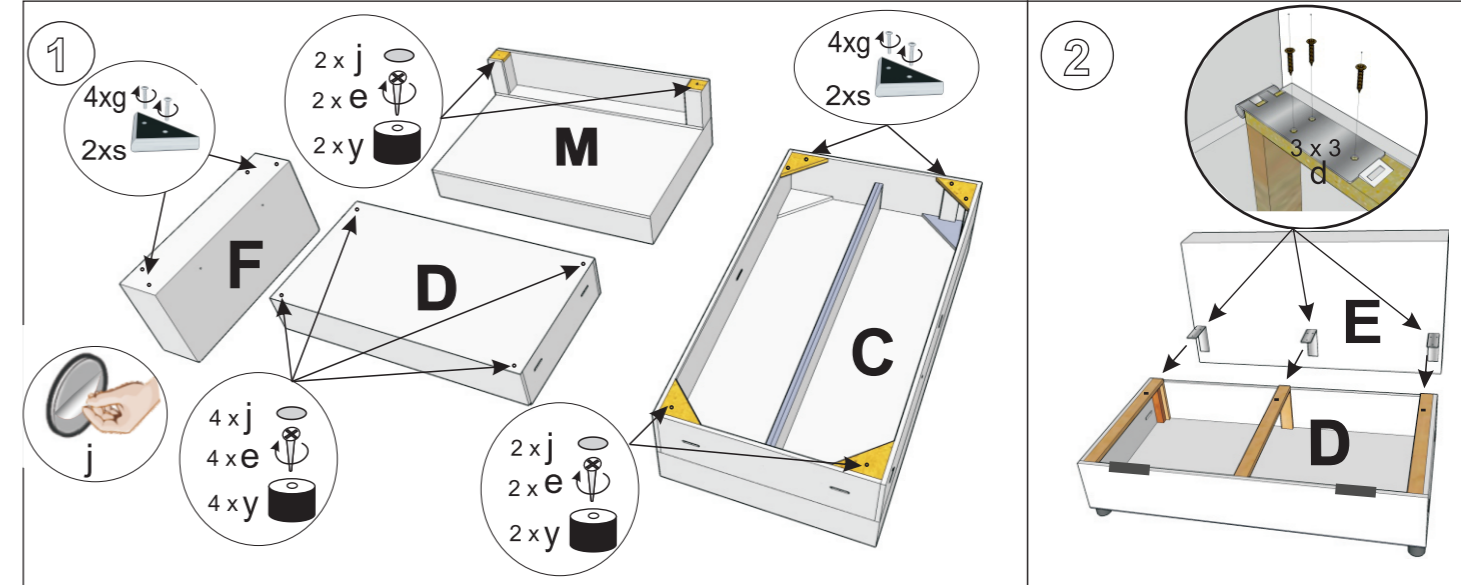

Ver:18.06.2024

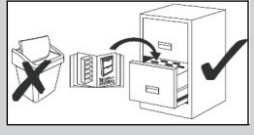
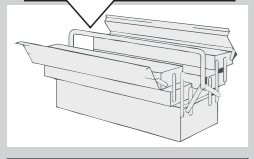
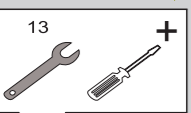
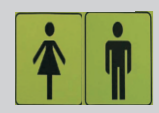

# JOHN 2 CORD



- (DE) Montageanleitung
- (IT) Istruzioni di montaggio
- (PL) Instrukcja montażu
- (FR) Notice de montage
- (NL) Handleiding voor de montage
- (RO) Instrucțiuni de asamblare
- (GB) Assembly instructions
- (SK) Montážny návod
- (TR) Montaj talimatı
- (CZ) Montážní návod
- (RU) Инструкция по монтажу
- (HU) Szerelési útmutató

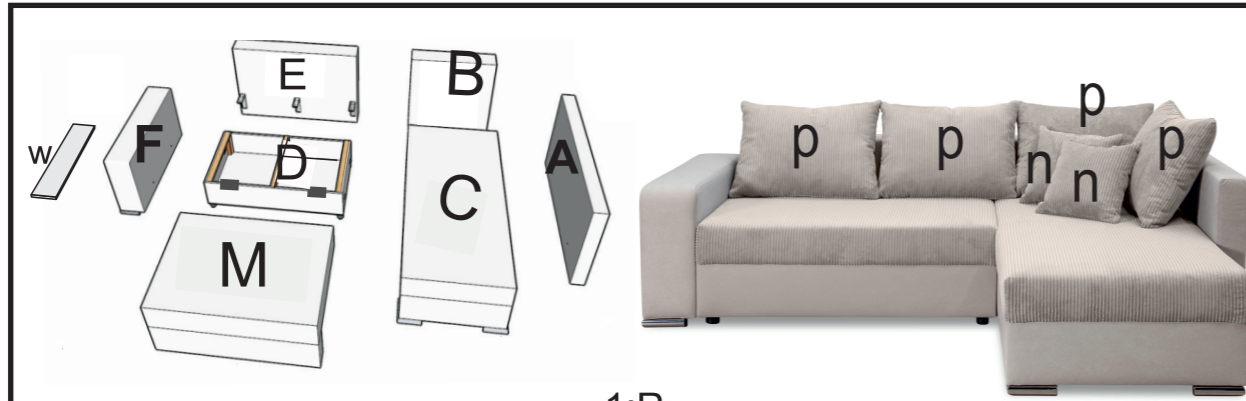

1:R

4x (M8x60)	4x (M8x90)	8x	8x Ø8	8x	8x M8	9x (4x16)	8x (5x35)
	8x (M6x35)	1x	8x	4x	2x	4x	

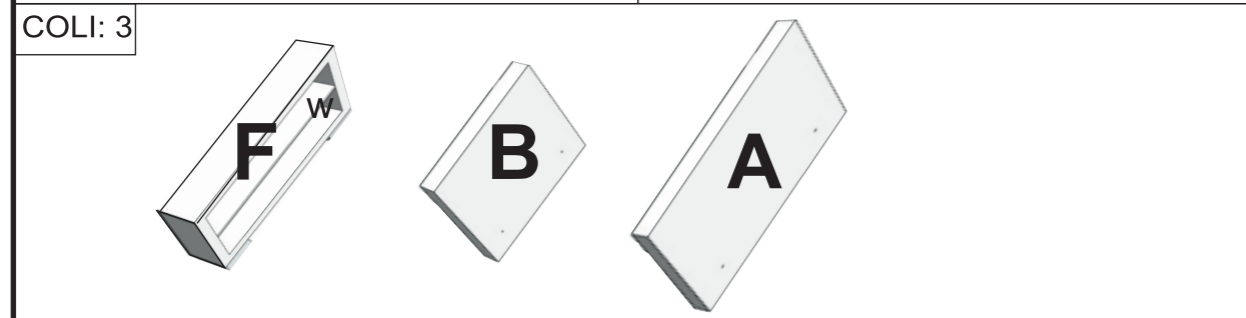
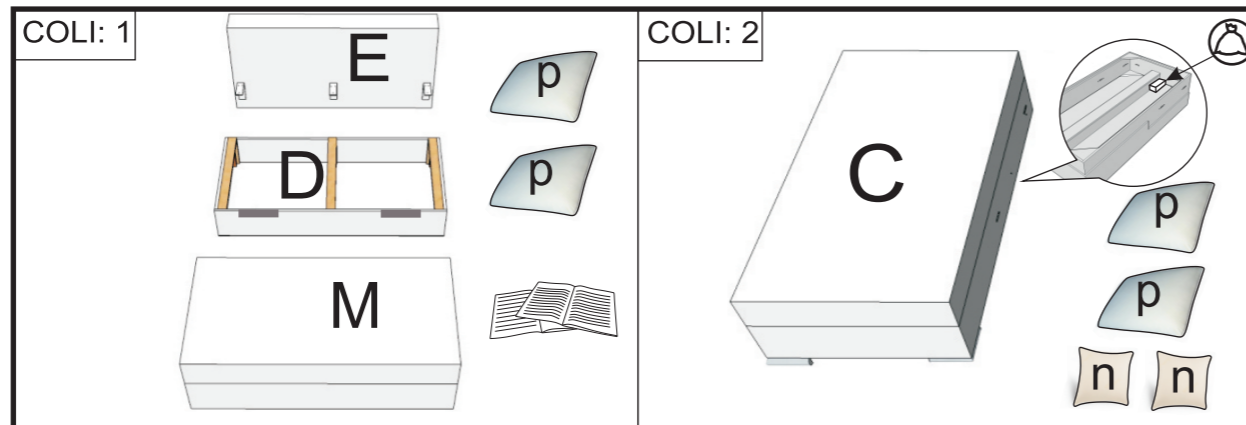

1 - John 2 - R

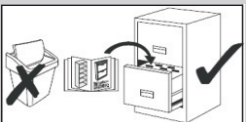
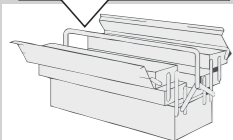
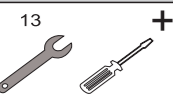
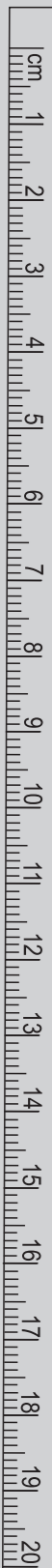
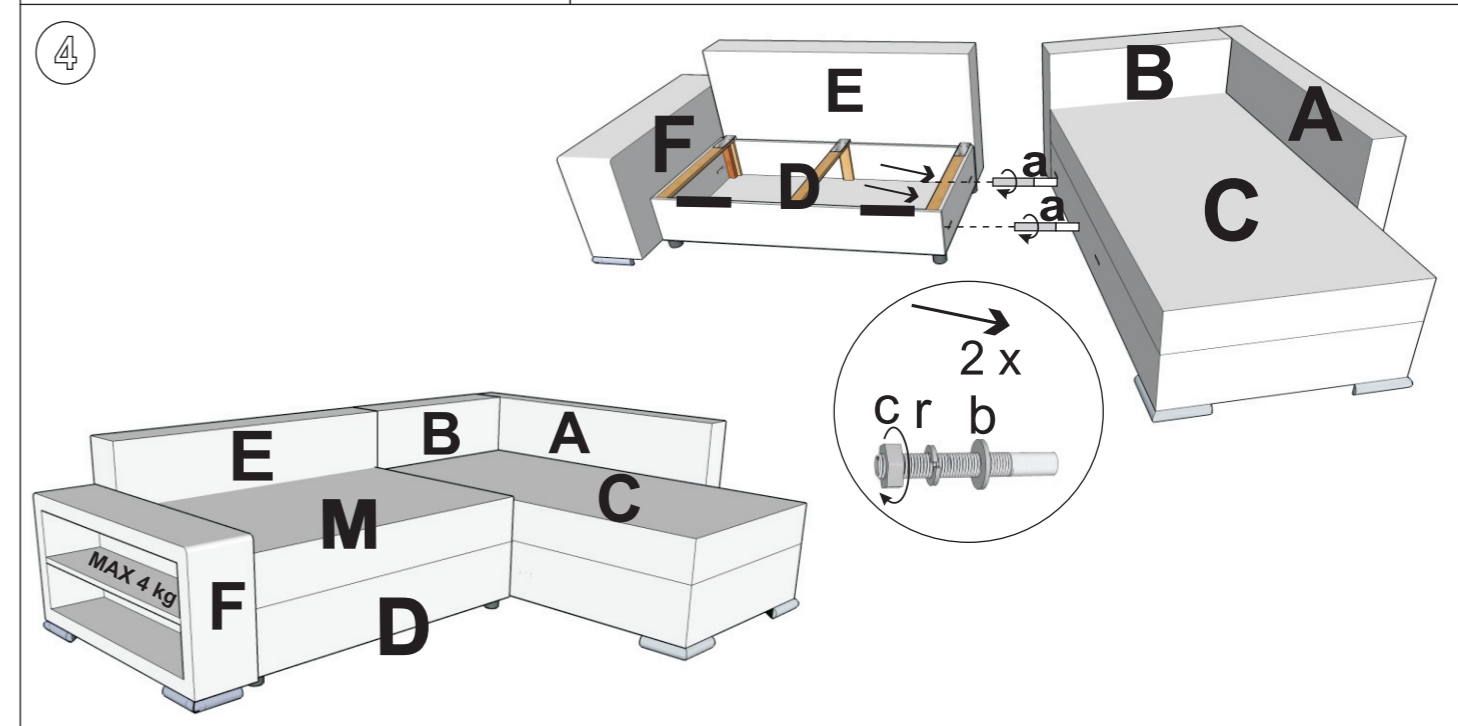
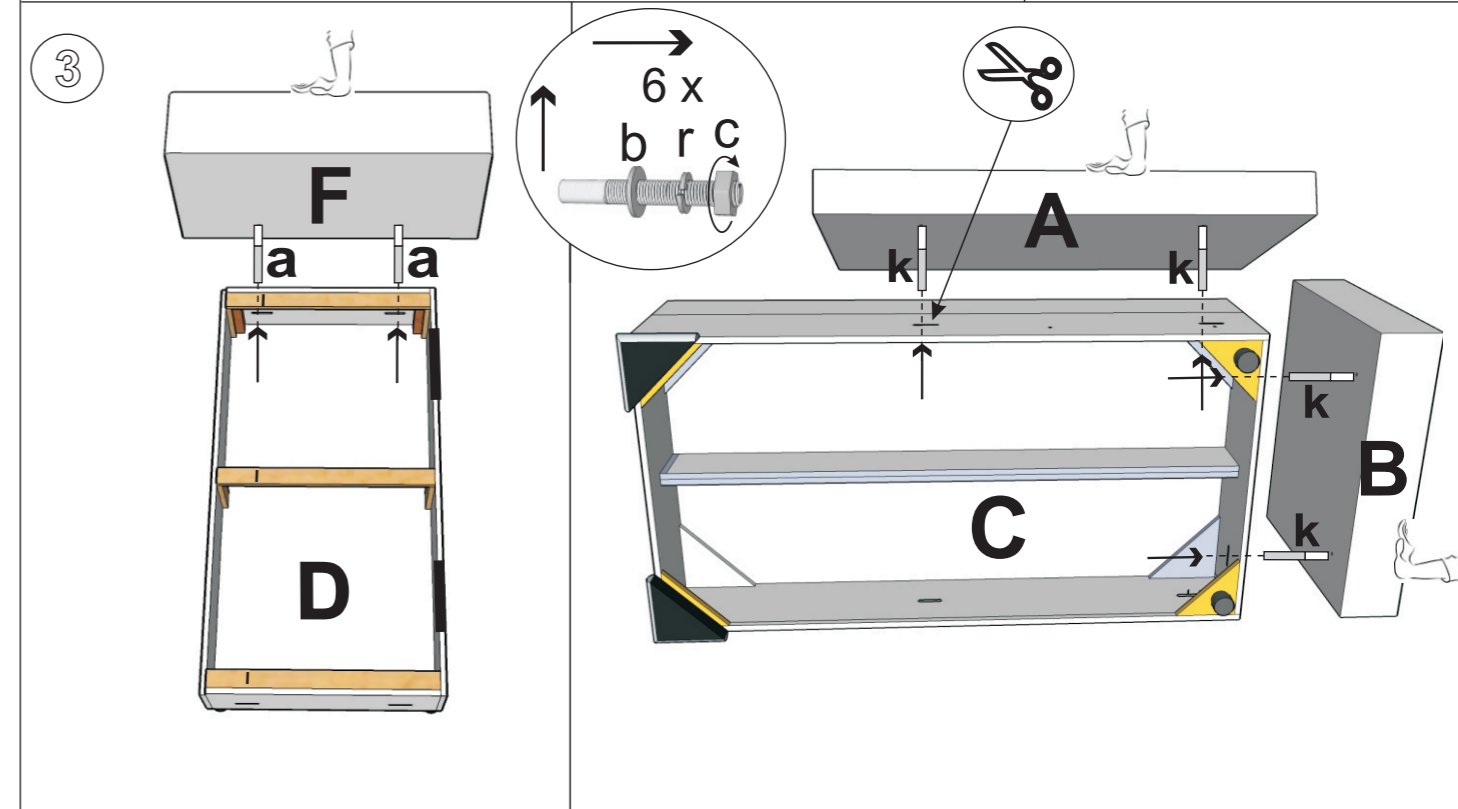
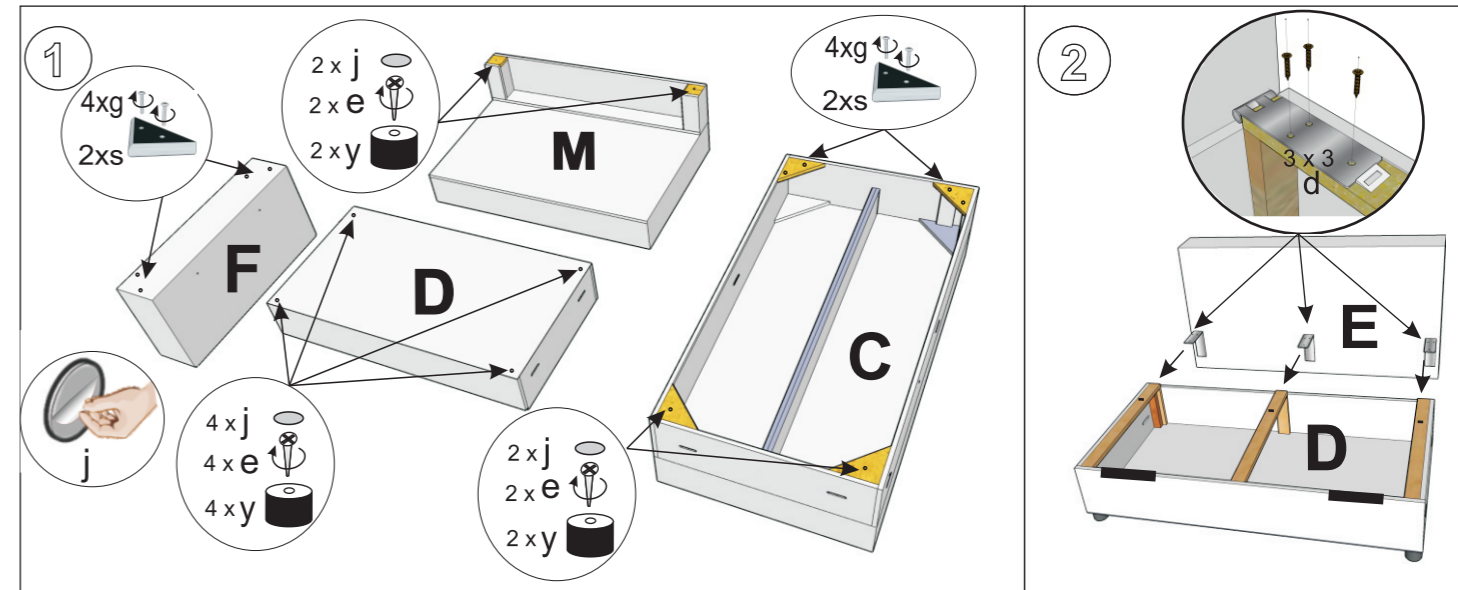

MAX 4 kg