

Art. Nr. 504727; 783478

LKZ 40605

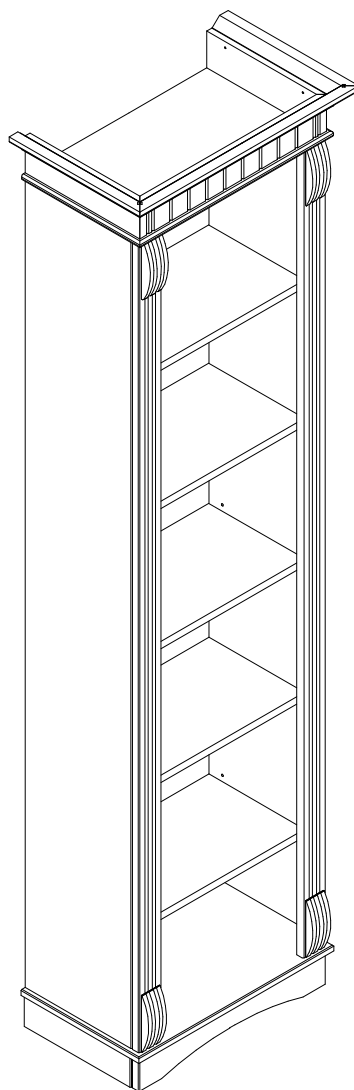

- | | | | |
|-----------|------------------------------------|-----------|--------------------------------|
| D | Montageanleitung | GB | Assembly instructions |
| FR | Notice de montage | IT | Istruzioni di montaggio |
| NL | Handleiding voor de montage | PL | Instrukcja montażu |
| CZ | Montážní návod | SK | Návod na montáž |
| HU | Szerelési útmutató | RO | Instrukțiuni de montaj |
| TR | Montaj talimatı | RU | Инструкция по монтажу |

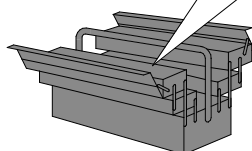
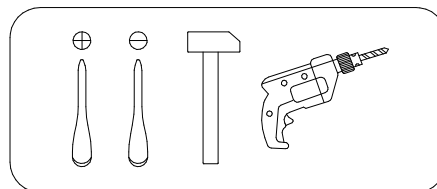
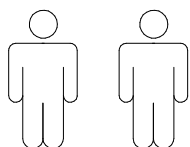

Service · Dienstverlening · Serwis · Servis · Сервисная служба

Name · Naam · Nazwa · Isim · Название

Nr. · No. · Номер

Typ · Type · Tip · Тип

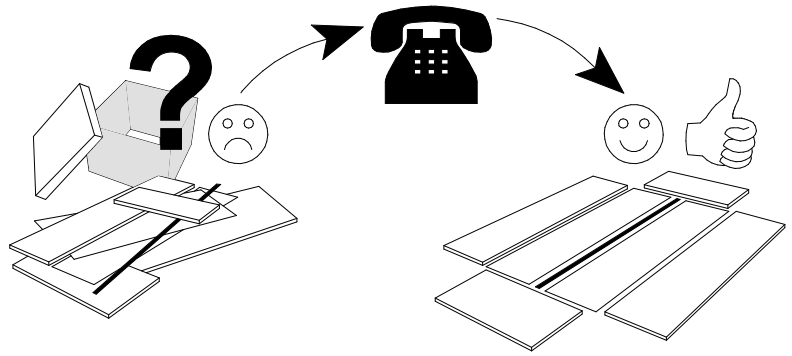
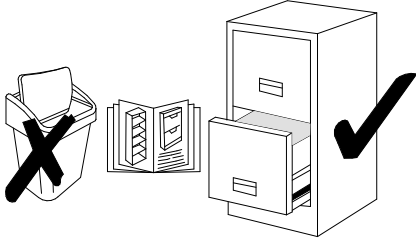

N	Size/MaB (mm)	Qty	✓	N	Size/MaB (mm)	Qty	✓
1	480×290	1		9	460x68	1	
2	480×290	1		10	262x68	1	
3	1724×262	2		11	262×68	1	
4	550x325	1		12	460×90	1	
5	1724×56	2		13	280×90	1	
6	1743×451	1		14	280×90	1	
7	432×252	2		15	120×44	4	
8	431×252	3					

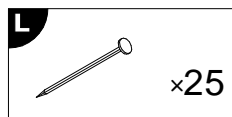
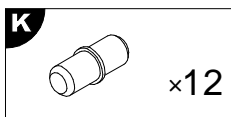
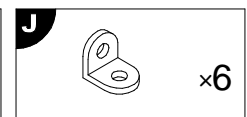
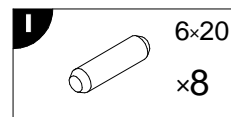
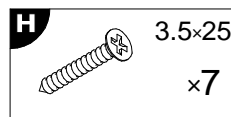
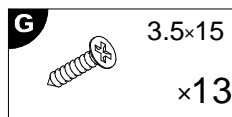
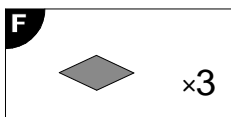
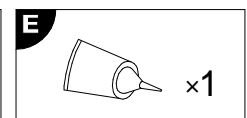
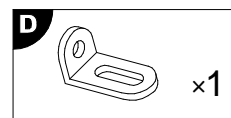
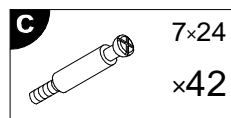
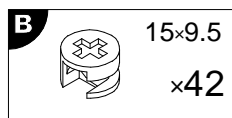
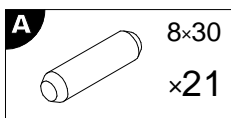

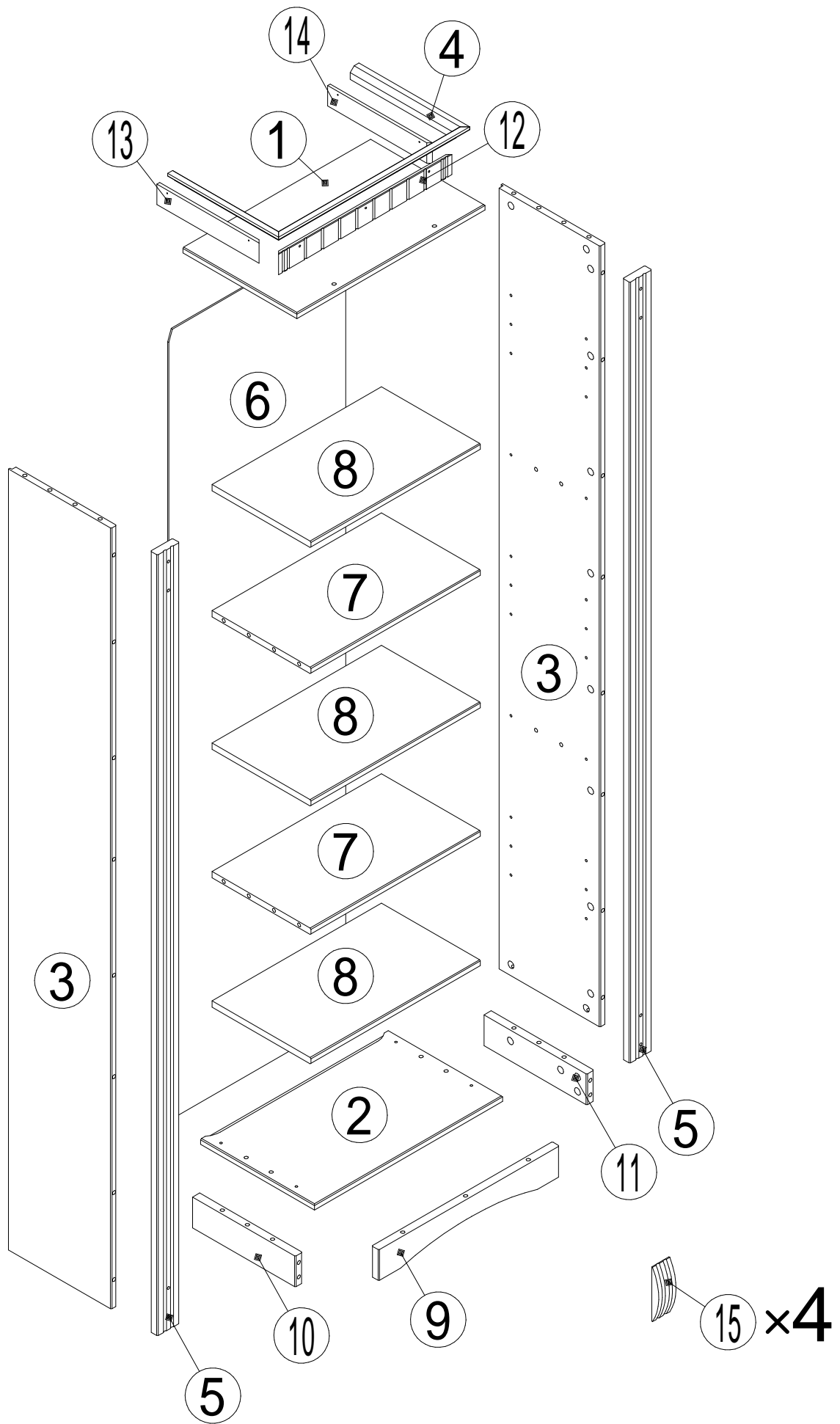

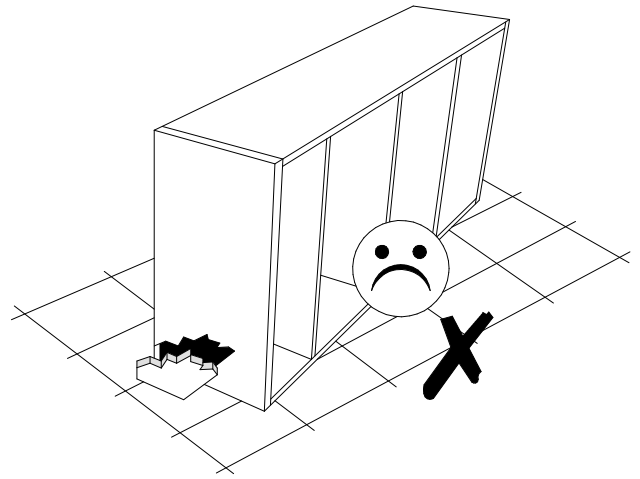
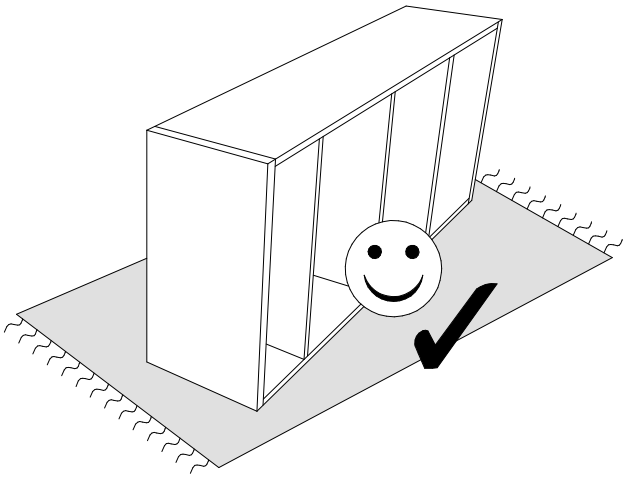

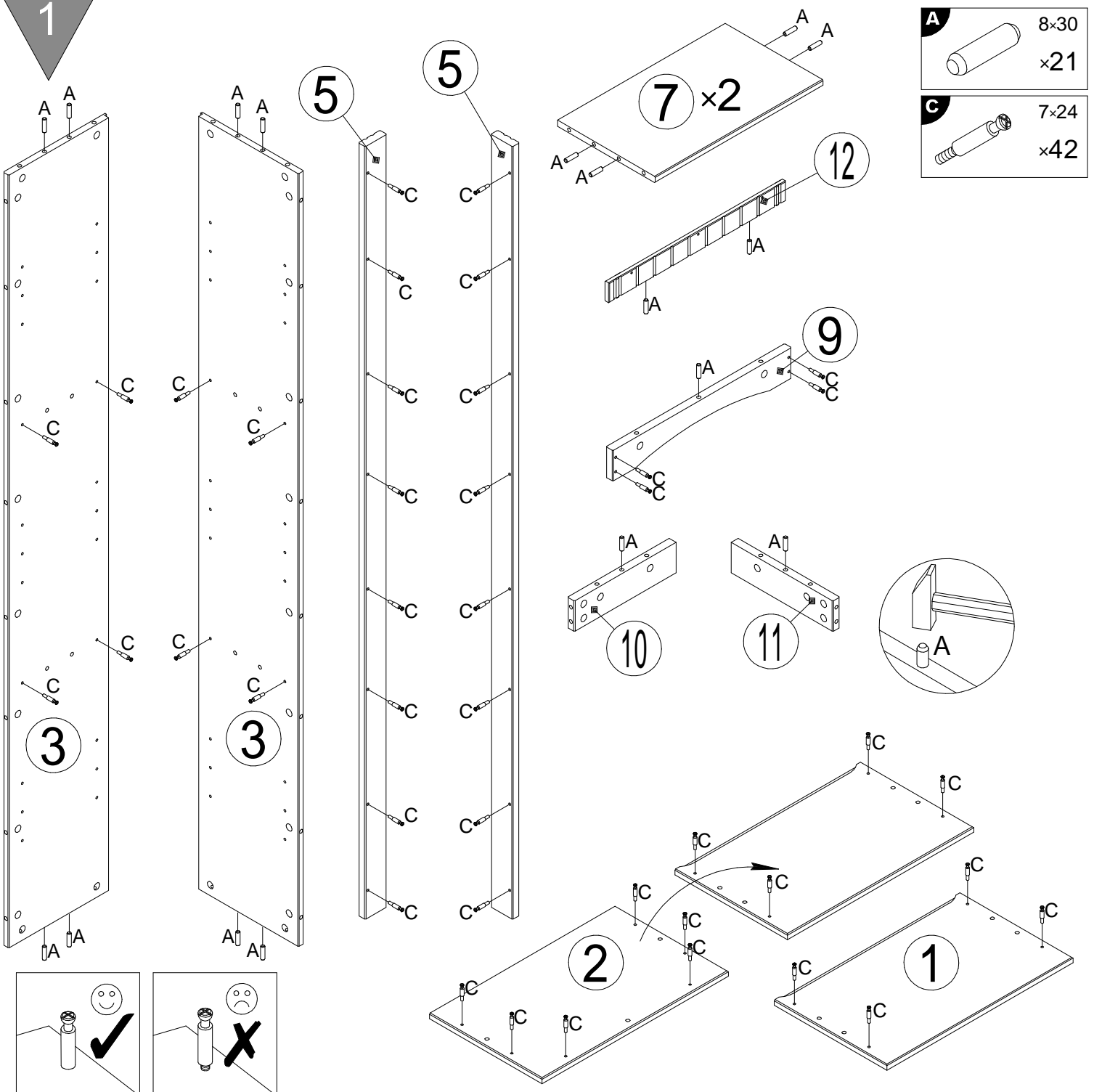

1

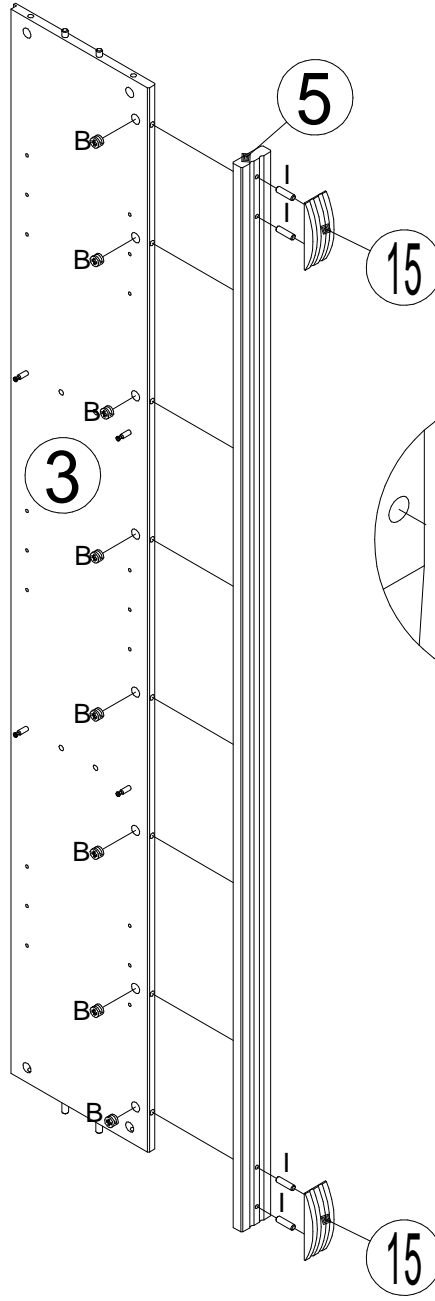
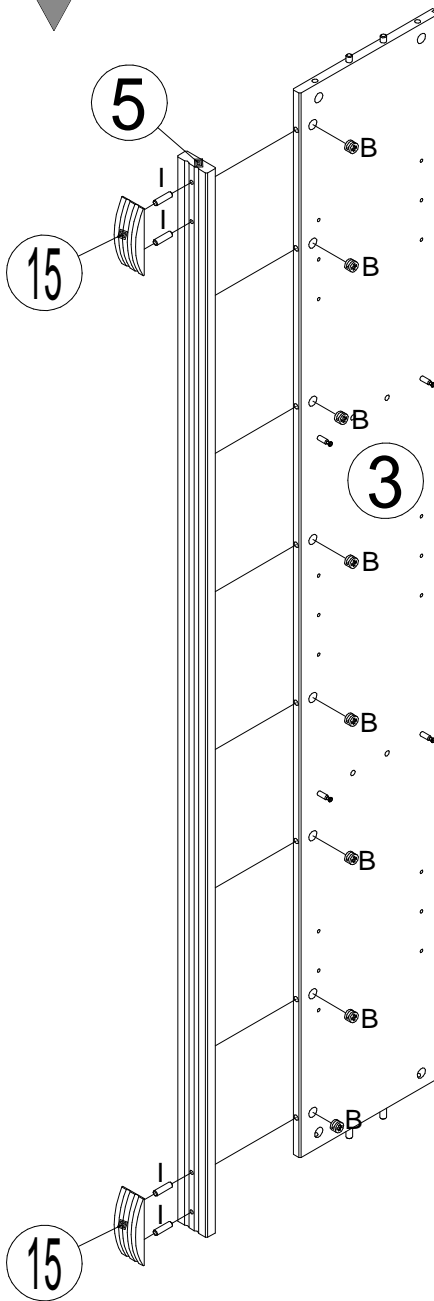

2



B 15x9.5
 x16

I 6x20
 x8

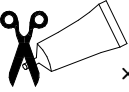
E  x1
 D Leim CZ Lepidlo
 GB Glue SK Glej
 FR Colle HU Enyv
 IT Colla RO Adeziv
 NL Lijm RU Клей
 PL Klej TR Tutkal

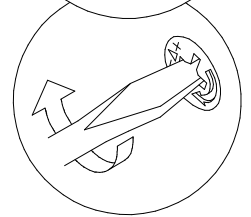
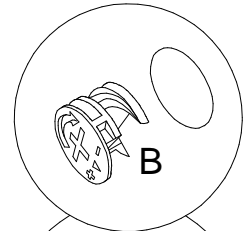
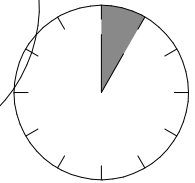
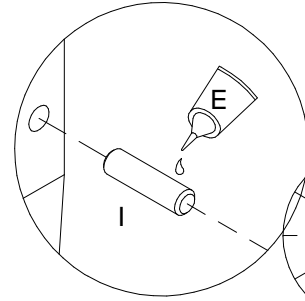

3

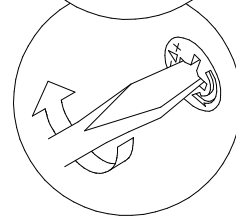
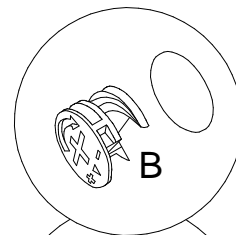
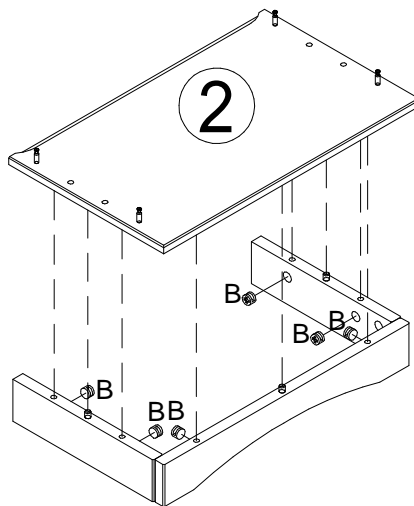

B 15x9.5
 x6

4

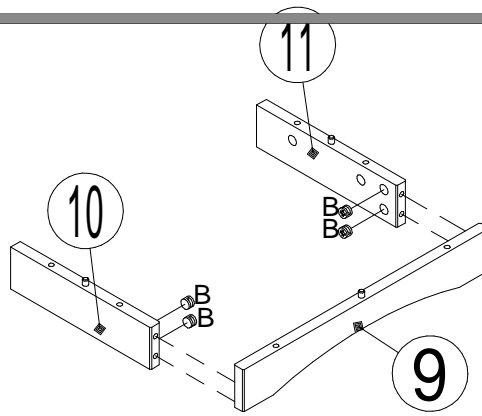

B 15x9.5
x4

5

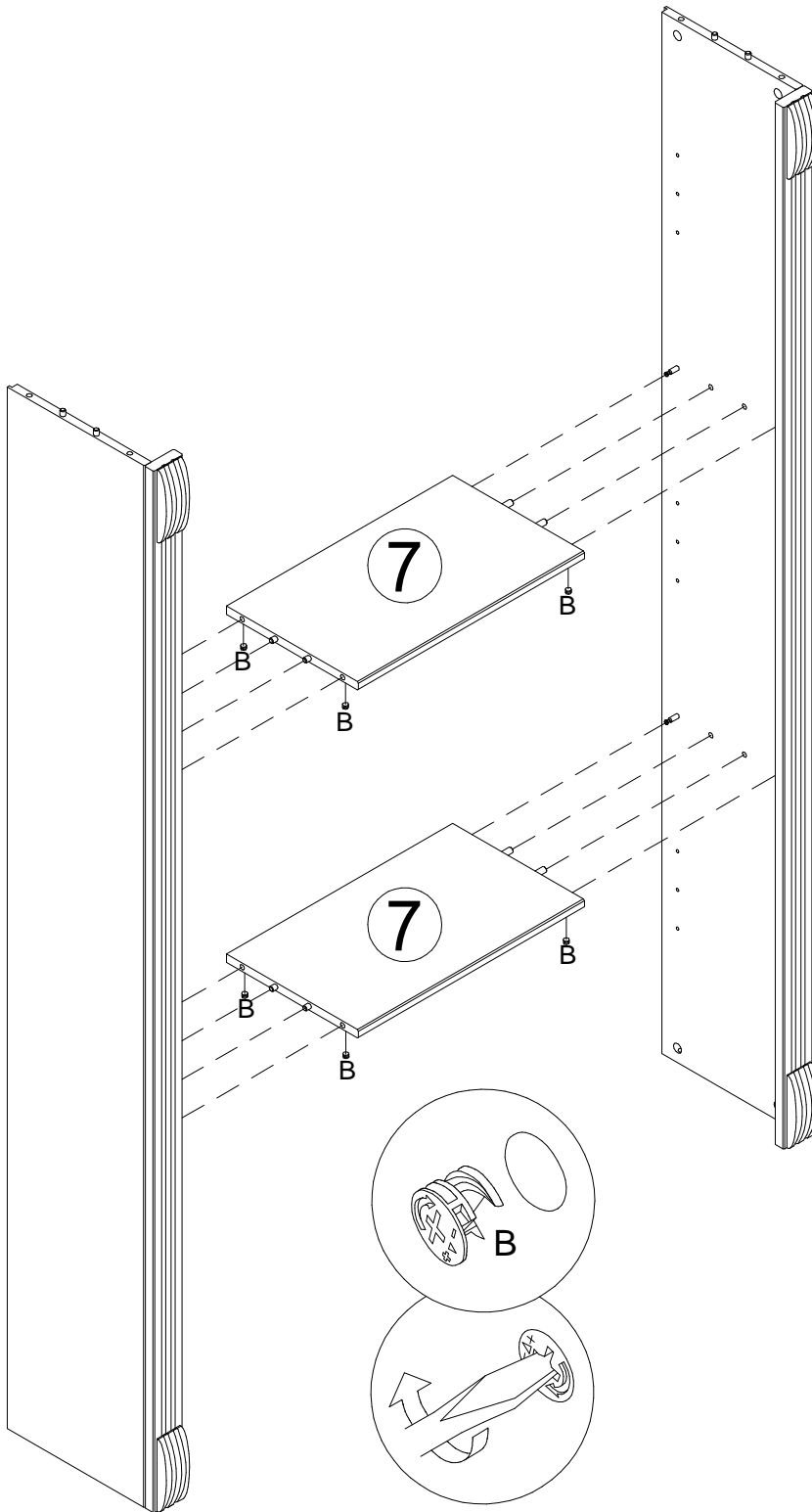

B 15x9.5
x8

6

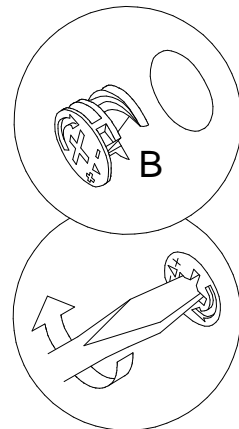
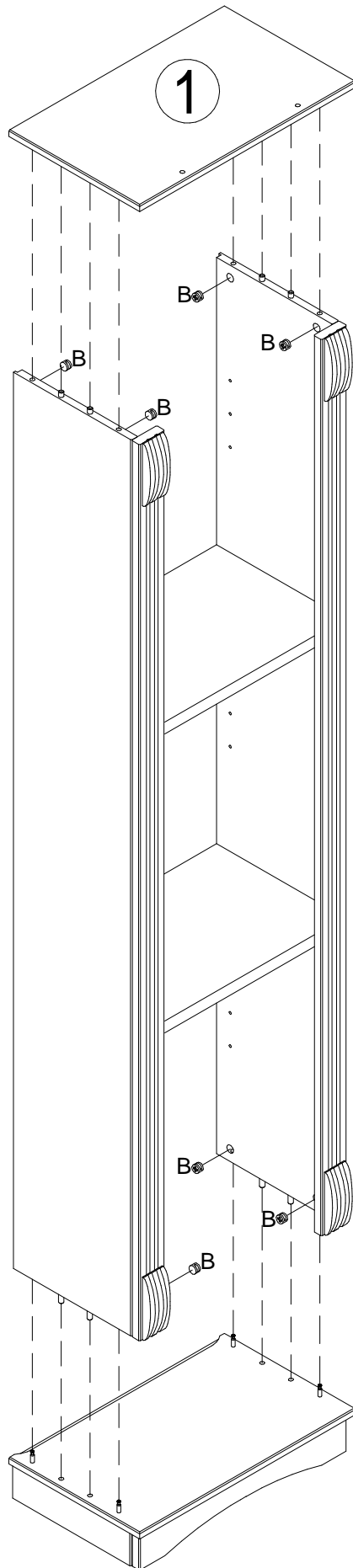

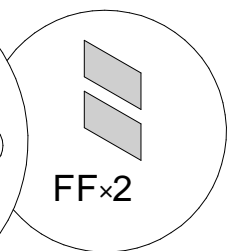
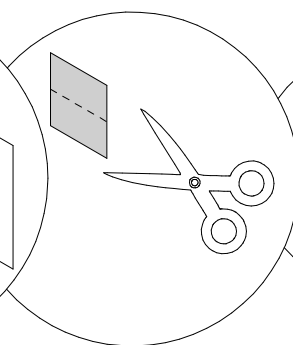
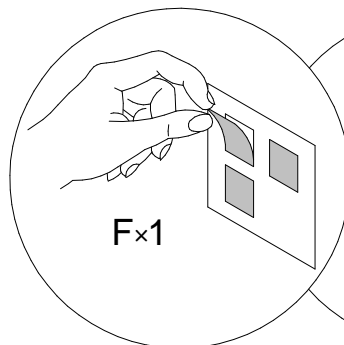
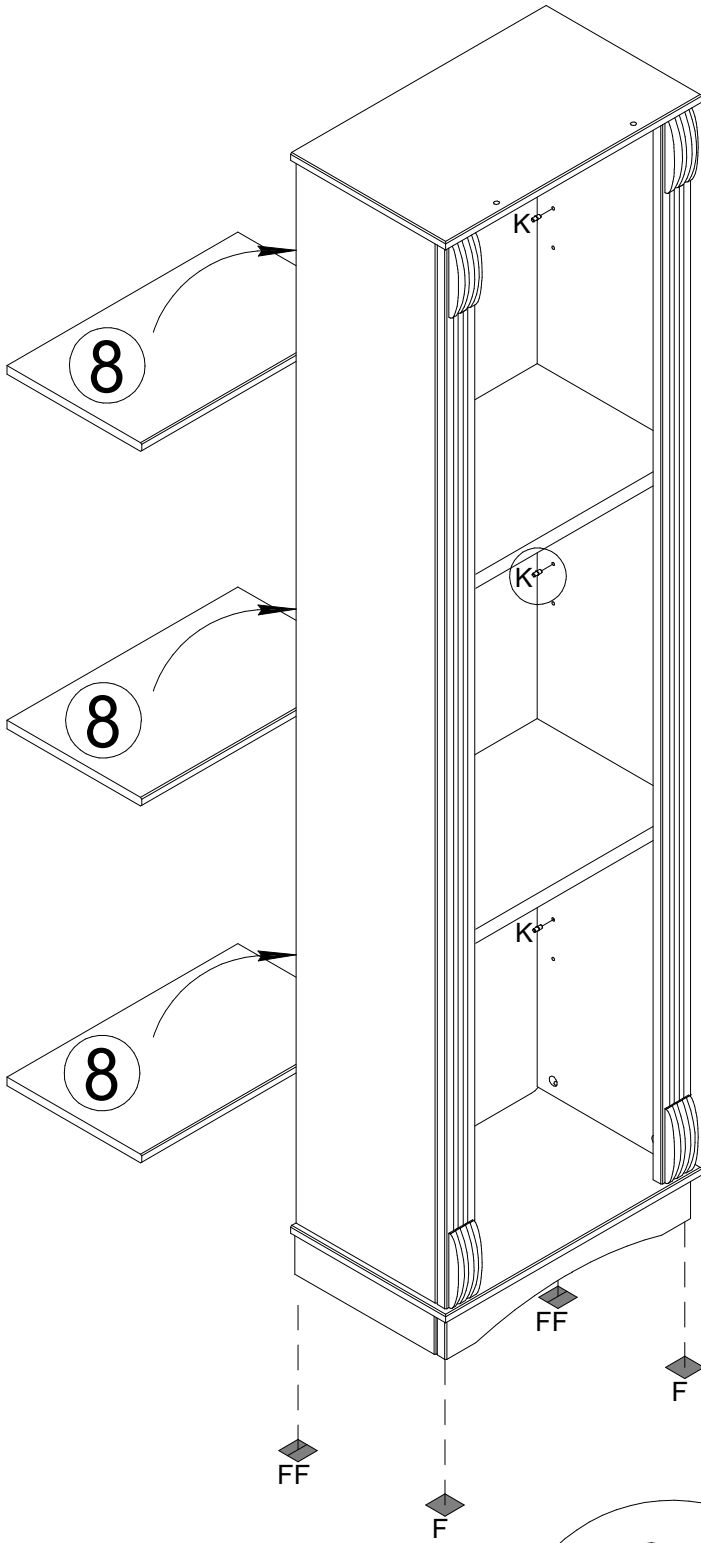
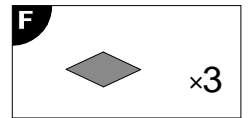
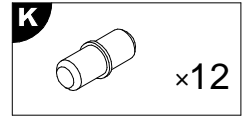

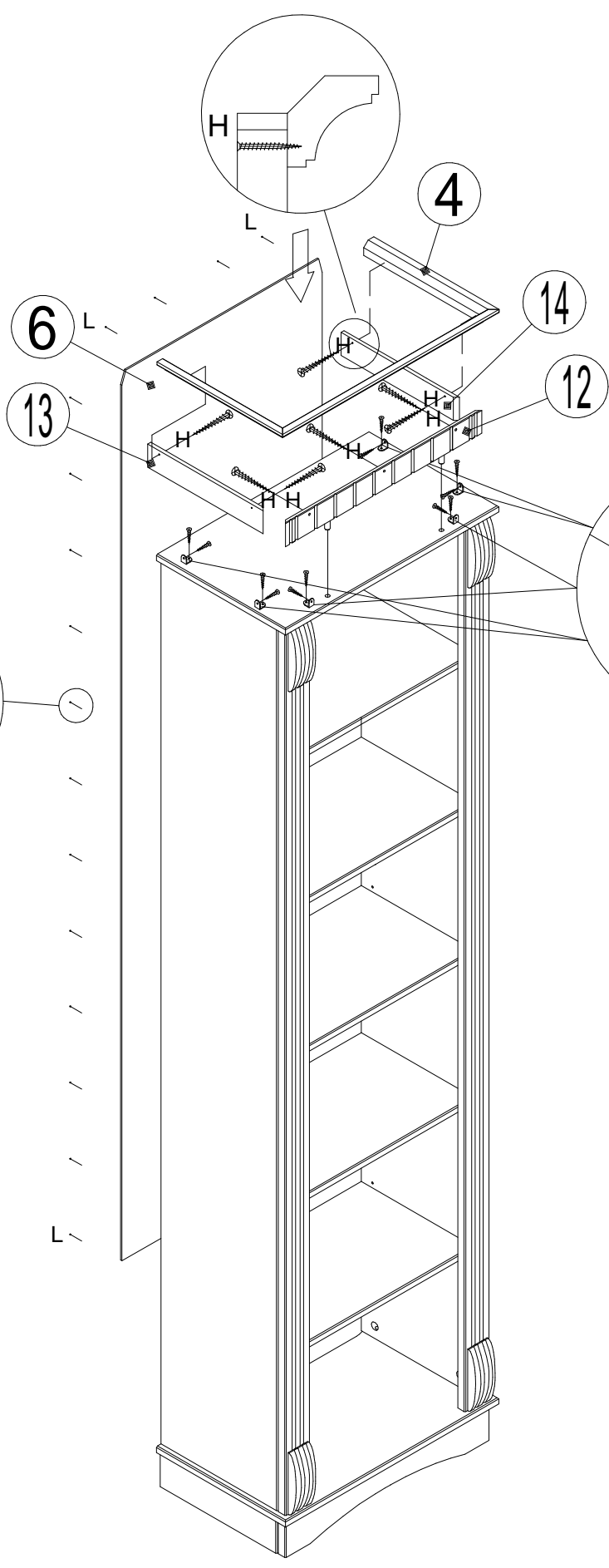
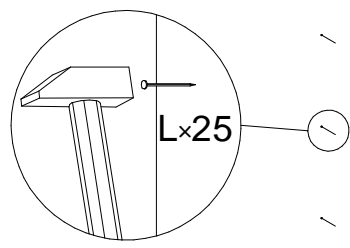

- G** 3.5x15
x12
- H** 3.5x25
x7
- J** x6
- L** x25

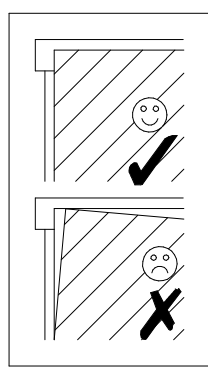
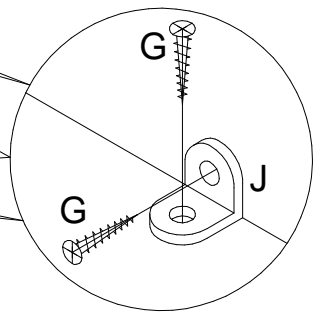

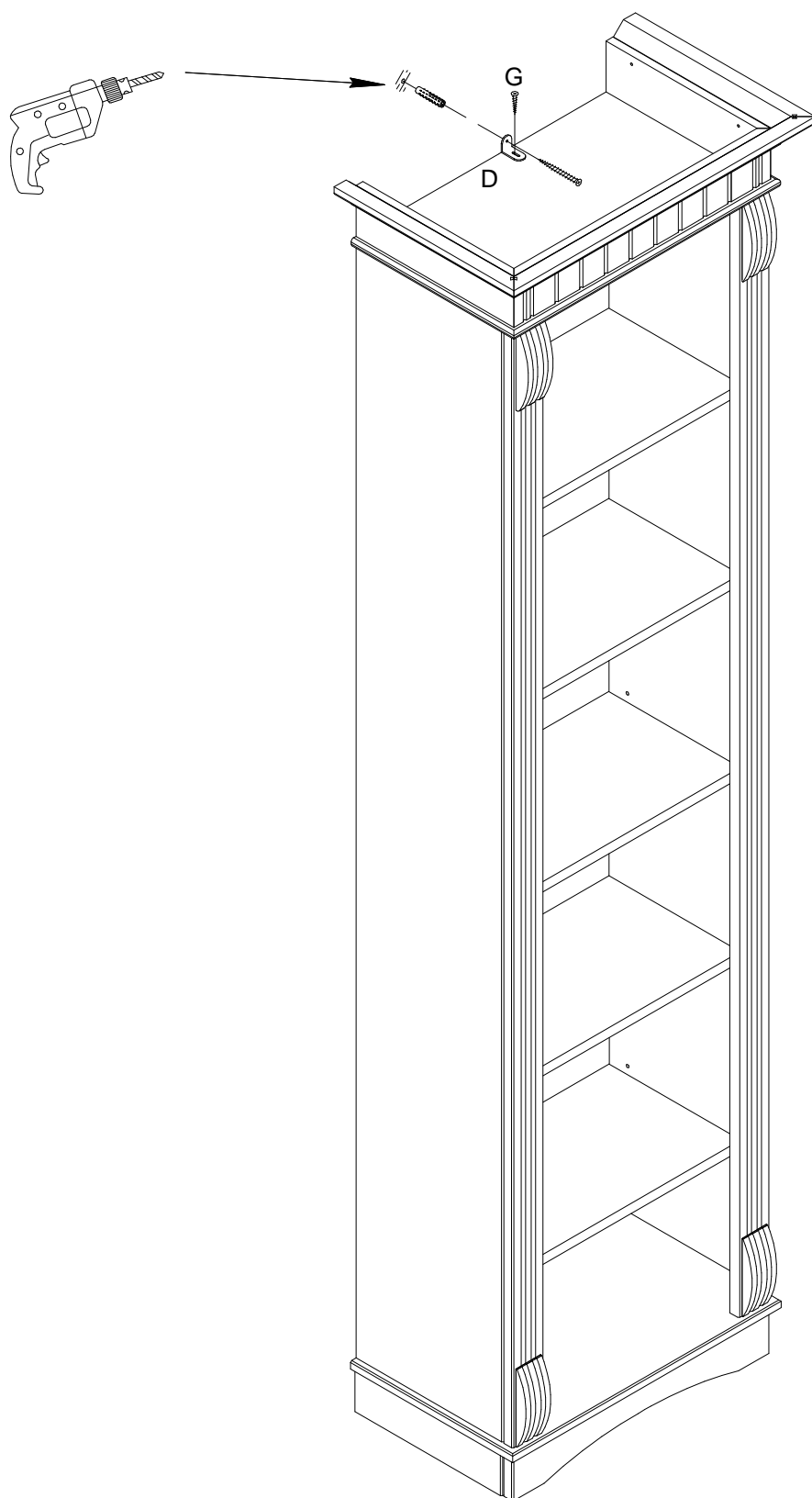
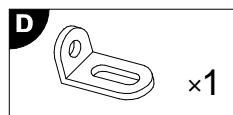
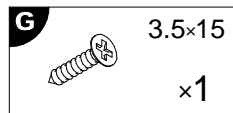



**Achtung • Attention • Attenzione
Opgelet • Uwaga • Pozor • Figyelem
Atenție • Dikkat • Внимание**



(D)	Wandbefestigung dient als Kippschutz – unbedingt anbringen! Bei einigen Wandtypen kann ein Spezialdübel erforderlich sein!
(GB)	The wall fastening serves to prevent tipping – be absolutely sure to mount it! For certain wall types, a special wall plug may be necessary!
(FR)	La fixation murale sert de protection contre le basculement – à installer impérativement ! Pour certains types de murs il faut des chevilles spéciales !
(IT)	Il fissaggio alla parete serve da protezione anti-ribaltamento – attaccarla assolutamente! Per alcune strutture di parete può essere necessario un tassello speciale!
(NL)	Bevestiging aan de muur dient als kantelbescherming – zeker en vast bevestigen! Bij enkele muurtypes is een speciale plug misschien vereist!
(PL)	Mocowanie do ściany jest jednocześnie zabezpieczeniem przed przewróceniem – koniecznie zamontować! Do niektórych rodzajów ścian koniecznie zastosować specjalne kołki mocujące.
(CZ)	Montáž na stěnu slouží jako ochrana proti převrhnutí – bezpodmienečně umístěte! U některých typů stěn může být zapotřebí speciální hmoždinka!
(SK)	Upevnenie na stenu slúži ako ochrana proti prevráteniu – bezpodmienečne použite! Pre niektoré druhy stien môže byť potrebná špeciálna hmoždinka!
(HU)	A terméket a falhoz kel rögzíteni, különben az felborulhat! Egyes faltípusoknál speciális tiplit kell használni!
(RO)	Sistemul de fixare la perete servește ca protecție la răsturnare – de montat obligatoriu! Pentru unele tipuri de pereți este posibil să fie necesar un diblu special!
(TR)	Duvardaki sabitleme, devrilmeye karşı bir emniyet tedbiridir ve mutlaka monte edilmelidir! Bazı duvar tiplerinde bunun için özel bir dübel gerekli olabilir!
(RU)	Обязательно установите крепление на стене во избежание опрокидывания! Для некоторых типов стен может потребоваться специальный дюбель!