

Art.Nr.: 7104 8303, 2839 0820, 6889 1160, 4220 2806, 3993 4826,  
7124 7651

---

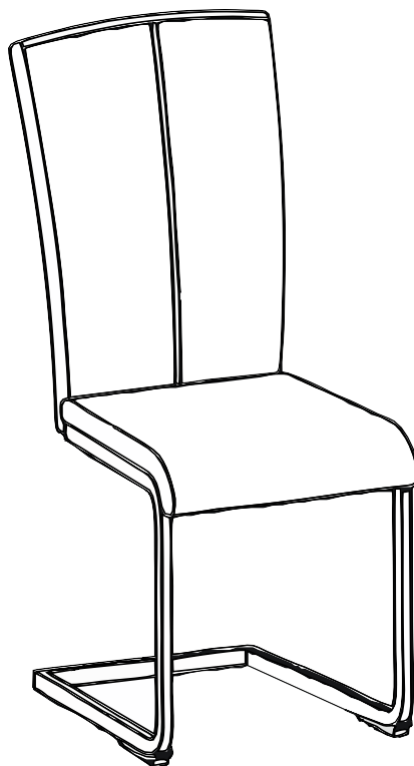

- |           |                                    |           |                                |
|-----------|------------------------------------|-----------|--------------------------------|
| <b>D</b>  | <b>Montageanleitung</b>            | <b>GB</b> | <b>Assembly instructions</b>   |
| <b>FR</b> | <b>Notice de montage</b>           | <b>IT</b> | <b>Istruzioni di montaggio</b> |
| <b>NL</b> | <b>Handleiding voor de montage</b> | <b>PL</b> | <b>Instrukcja montażu</b>      |
| <b>CZ</b> | <b>Montážní návod</b>              | <b>SK</b> | <b>Návod na montáž</b>         |
| <b>HU</b> | <b>Szerelési útmutató</b>          | <b>RO</b> | <b>Instrucțiuni de montaj</b>  |
| <b>TR</b> | <b>Montaj talimatı</b>             | <b>RU</b> | <b>Инструкция по монтажу</b>   |

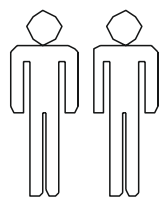

---

**LKZ040779**

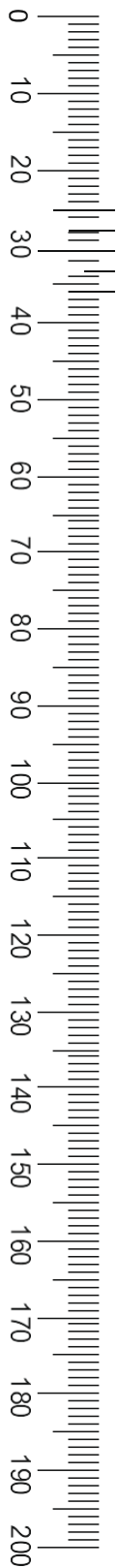

# Service . Assistenza . Dienstverlening . Serwis Servis . Szerviz

Name.Nom.Nome.Naam.  
Nazwa.Jmeno.Nazov.Nev  
Denumire.Isim

**ALEX**

Nr.No.N.Homep.Č.Sz  
5577 8346, 9310 7906, 7862 7848, 4190 4628,  
2933 5761, 3536 4147, 8949 9146, 4722 3218,  
2303 6535

Typ . Type . Tip . Tipus . Tipo

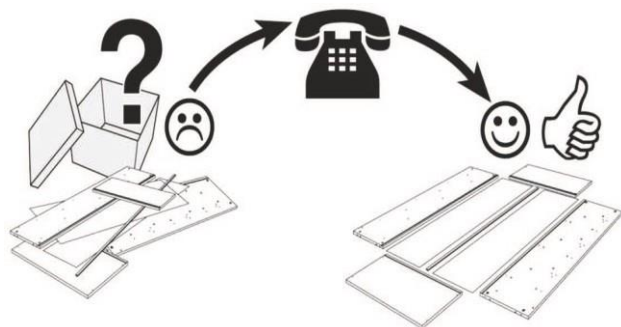
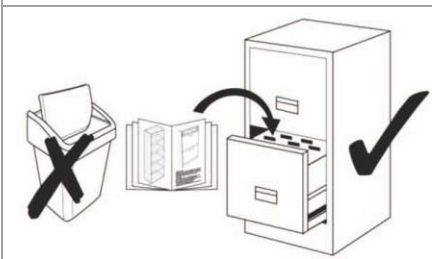

<b>A</b>  1PC	<b>B</b>  1PC	<b>C</b>  1PC	<b>D</b>  M6 × 5mm 8PCS	<b>E</b>  4PCS
<b>F</b>  4mm 1PC	<b>G</b>  2PCS	<b>H</b>  2PCS	<b>I</b>  M5X 6 2PCS	

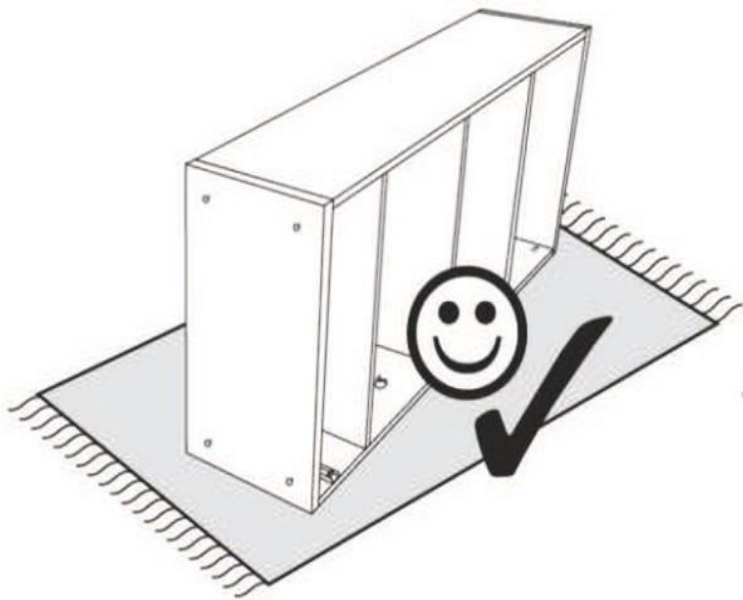

1

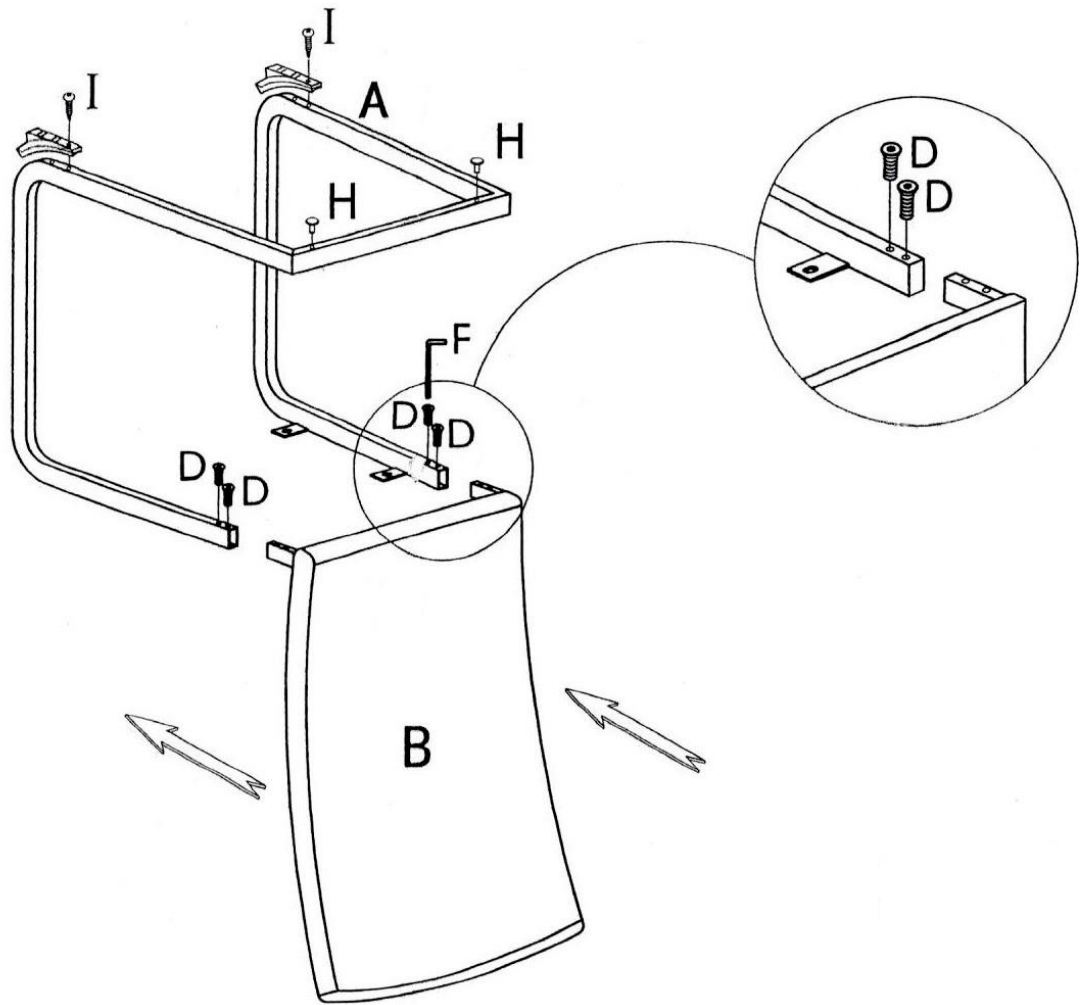
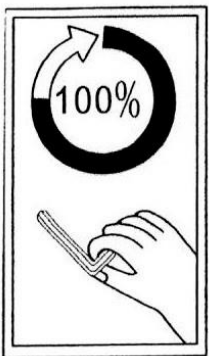

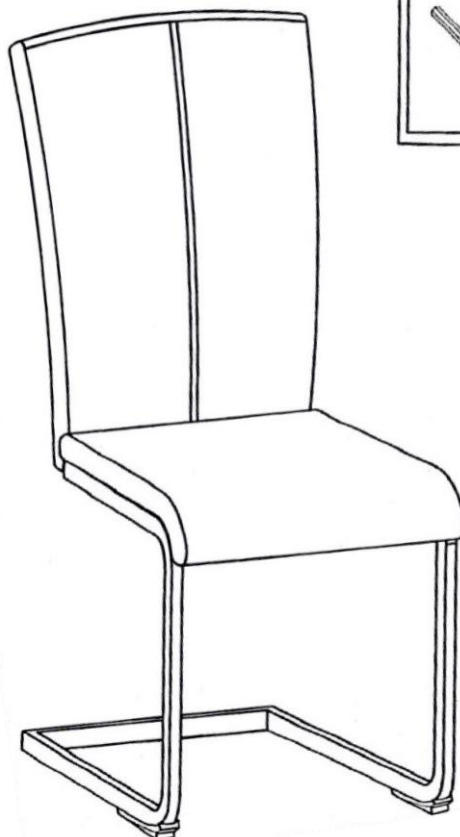
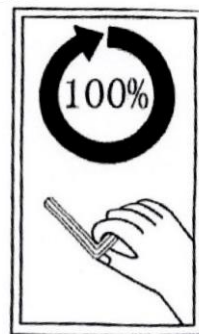
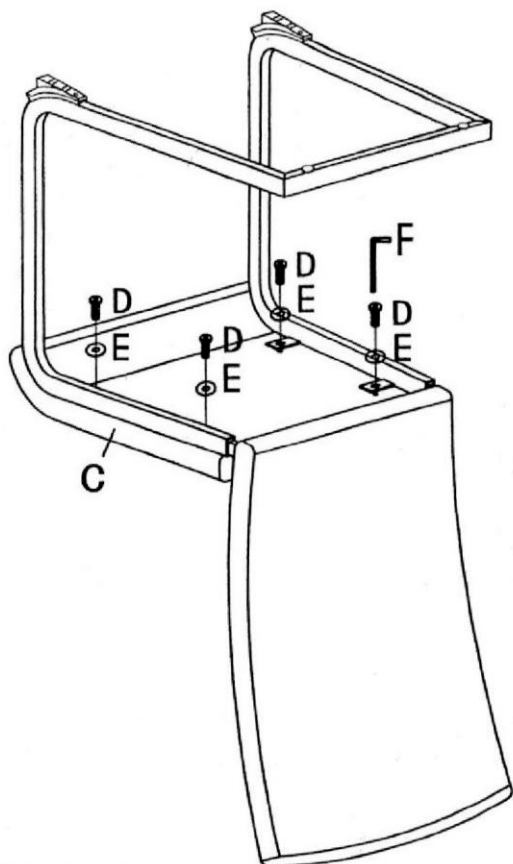
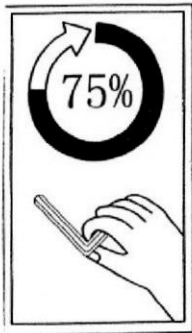

**D Allgemeiner Sicherheitshinweis:**

Nicht mehr benötigte Verpackungs-Materialien und Kleinteile von Kindern fernhalten!

**GB General safety instructions:**

Package material you do not need any more take far away from children.

**F Consigne de sécurité:**

Ecartez les matériaux d'emballage et petites pièces inutiles de la portée des enfants.

**PL Ogólne zasady bezpieczeñstwa:**

Nie potrzebne opakowania i małe części chronić przed dziećmi!

**RU Общие указания по безопасности:**

Неиспользуемые упаковочные материалы и мелкие детали следует хранить в недоступном для детей месте!

**NL Algemene veiligheidsinstructie:**

Verpakkingsmaterialen die u niet meer nodig heeft en kleine onderdelen uit de buurt van kinderen houden!

**TR Genel güvenlik uyarısı:**

Kullanılmayan ambalaj malzemeleri ve küçük parçaları çocuklardan uzak tutun!

**RO Indicație generală de siguranță:**

Ambalajele care nu mai sunt necesare și piesele de mici dimensiuni nu vor fi lăsate la îndemâna copiilor!

**IT Indicazioni generali per la sicurezza:**

Tenere lontano da bambini materiali di imballaggio non più necessari e minuterie!

**SK Všeobecné bezpečnostné upozornenie:**

Nepotrebný baliaci materiál a malé diely uchovávajte mimo dosahu detí!

**CZ Všeobecné bezpečnostní upozornění:**

Obalové materiály a malé díly, které už nepotřebujete, udržujte mimo dosah dětí!

**HU Általános biztonsági tudnivaló:**

Ha már nincs szüksége a csomagolóanyagokra és apró darabokra, tegye őket olyan helyre, ahol nem férhetnek hozzá gyermekek!