

1661844 | 1661845 | 1661846

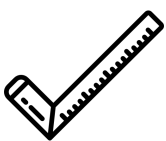
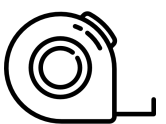
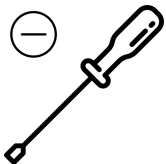
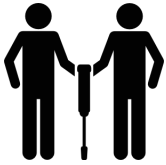
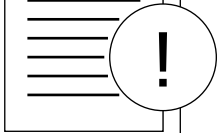
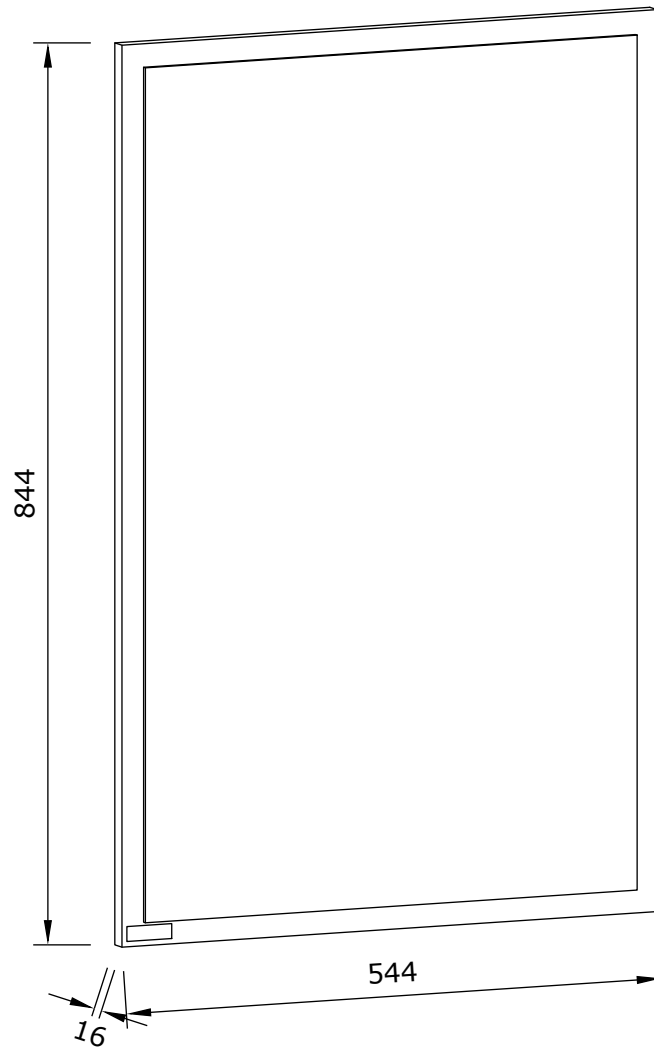

D *Montageanleitung*

NL *Handleiding voor de montage*

TR *Montaj talimatı*

FR *Notice de montage*

CZ *Montážní návod*

HU *Szerelési útmutató*

GB *Assembly instructions*

PL *Instrukcja montażu*

RU *Инструкция по монтажу*

IT *Istruzioni di montaggio*

SK *Návod na montáž*

RO *Instrucțiuni de montaj*

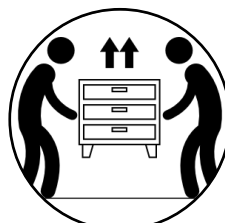

Name • Nom • Nome • Naam
 Nazwa • Jméno • Názov • Név
 Denumire • Ísim • Название

Nr. • No. • N° • Номер • Č • Sz

Typ • Type • Tip • Típus • Tipo
 Тип

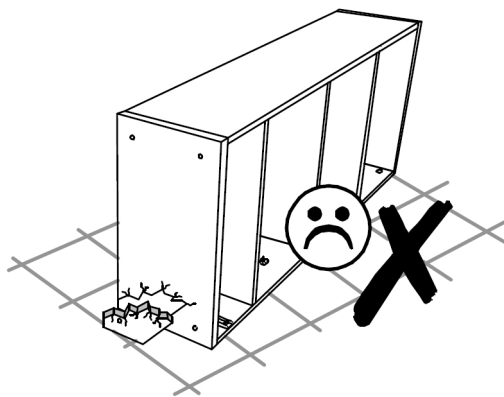
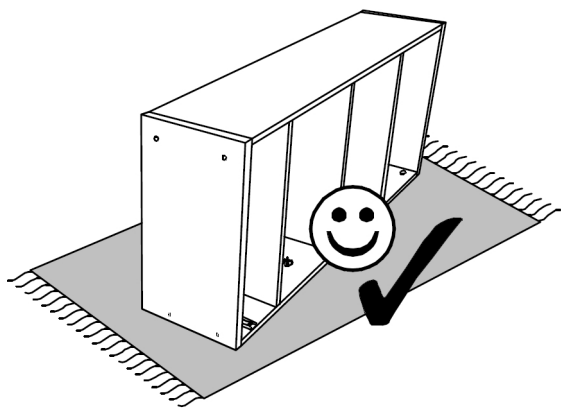
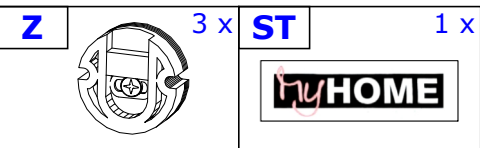
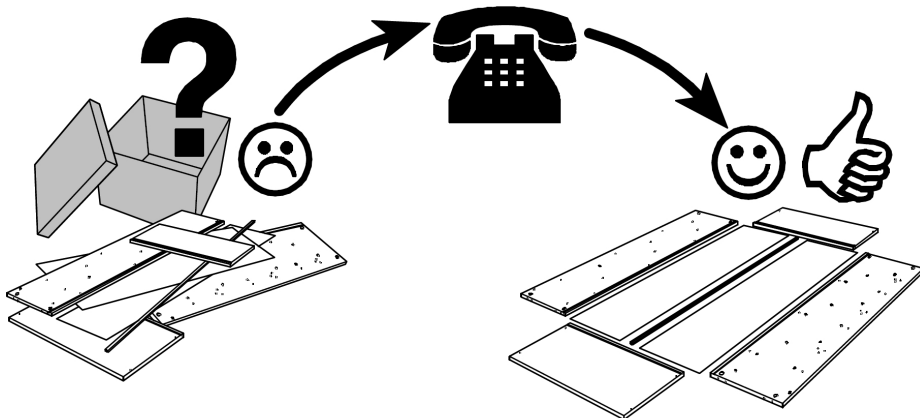
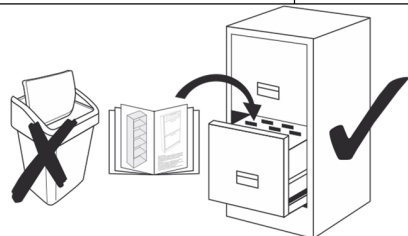

A

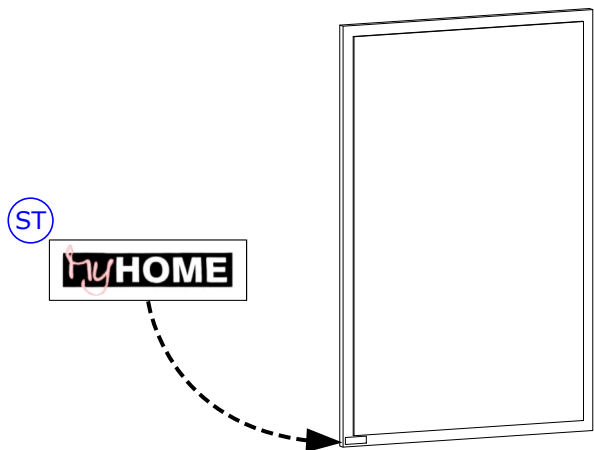

B

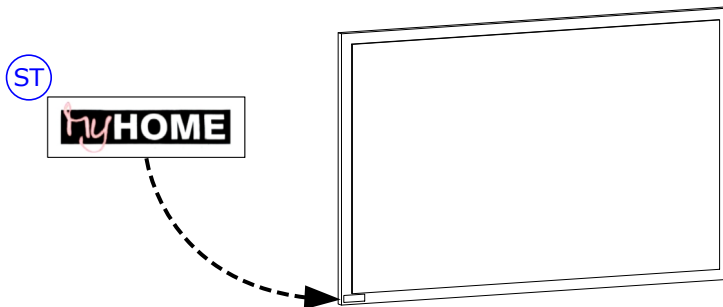

A

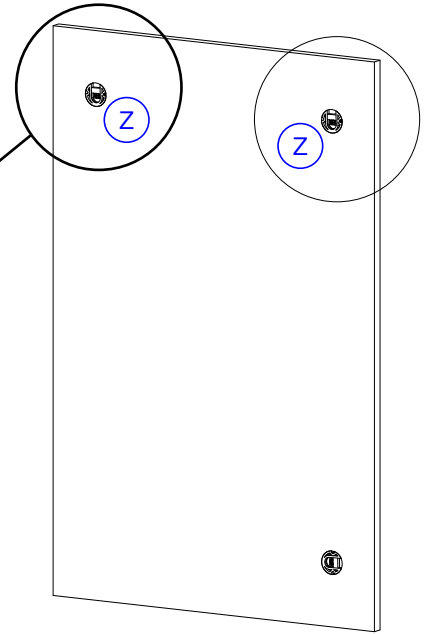
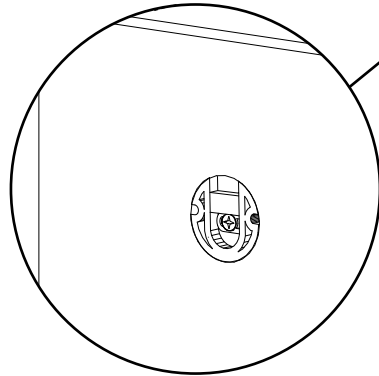
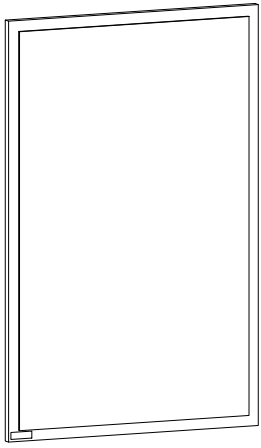

B

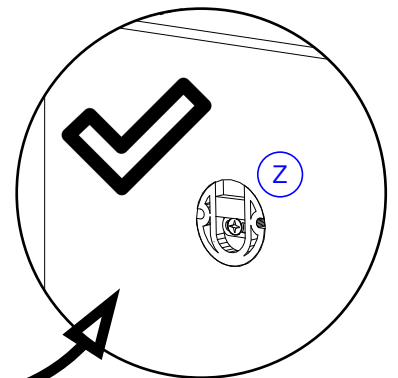
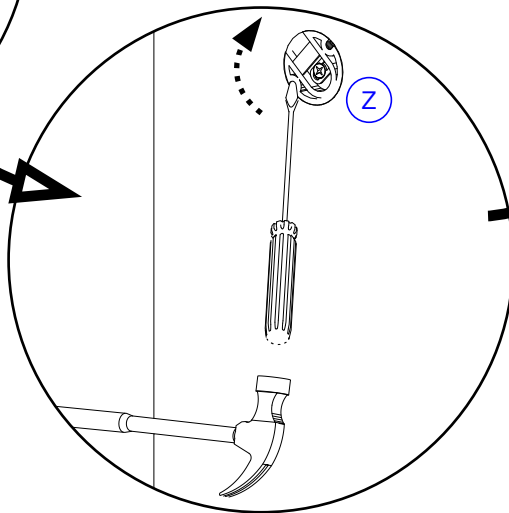
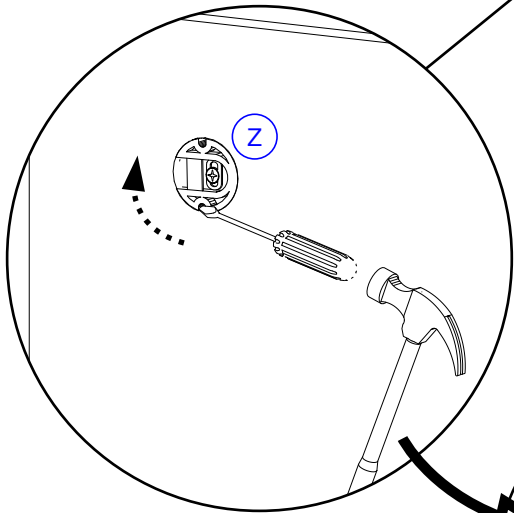
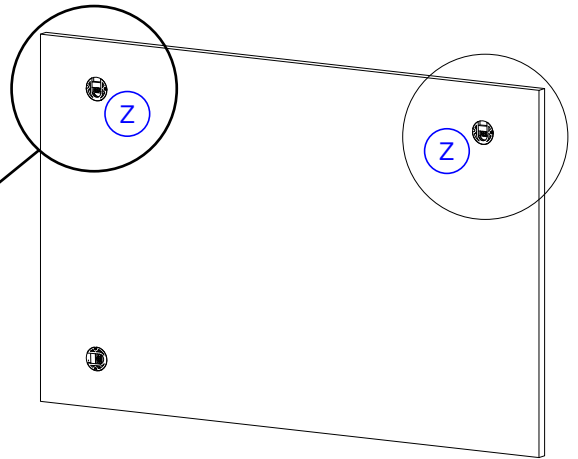
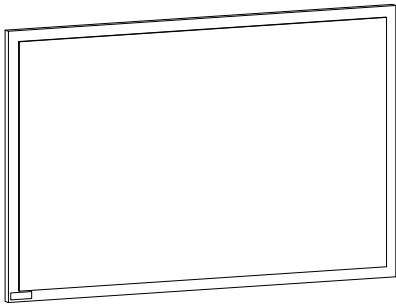

(D)	Schrauben sind nicht enthalten. Bei einigen Wandtypen kann ein Spezialdübel erforderlich sein!
(GB)	Screws are not included. For certain wall types, a special dowel may be necessary!
(NL)	Schroeven zijn niet inbegrepen. Bij enkele muurtypes is een speciale plug misschien vereist!
(PL)	Wkręty nie są dołączone. Do niektórych rodzajów ścian konieczne mogą być specjalne wkręty!
(TR)	Vidalar dahil değildir. bunun için özel bir dübel gerekli olabilir!
(RU)	Винты в комплект не входят. потребуется специальный дюбель!
(FR)	Les vis ne sont pas incluses. Pour certains types de murs il faut des chevilles spéciales !
(IT)	Le viti non sono incluse. Per alcune strutture di parete può essere necessario un tassello speciale!
(CZ)	Šrouby nejsou součástí dodávky. U některých typů stěn může být zapotřebí speciální hmoždinka!
(SK)	Skrutky nie sú súčasťou balenia. Pre niektoré druhy stien môže byť potrebná špeciálna hmoždinka!
(HU)	A csavarokat nem tartalmazza. Egyes faltípusoknál speciális tiplit kell használni!
(RO)	Șuruburile nu sunt incluse. Pentru unele tipuri de pereți este posibil să fie necesar un diblu special!

