

**2 X** | **20 MIN**

- (D) AUFBAUANLEITUNG
- (NL) HANDLEIDING VOOR DE MONTAGE
- (TR) MONTAJ TALIMATI
- (RO) INSTRUCIUNI DE ASAMBLARE
- (F) INSTRUCTION D'ASSEMBLAGE
- (CZ) POKYNY K MONTÁŽI
- (BG) ИНСТРУКЦИИ ЗА МОНТАЖ
- (HR) NAPUTCI ZA MONTAŽU
- (E) INSTRUCCIONES DE MONTAJE

- (GB) ASSEMBLY INSTRUCTIONS
- (PL) INSTRUKCJA MONTAŻU
- (RU) Инструкция по монтажу
- (I) PROCEDURA DI ASSEMBLAGGIO
- (SK) POKYNY K MONTÁŽI
- (HU) KÖZGYŰLÉS UTASÍTÁSOK
- (SL) ASSEMBLY INSTRUCTIONS
- (S) MONTERINGSANVISNING
- (LT) DIEGIMO INSTRUKCIJOS



„MICKY”

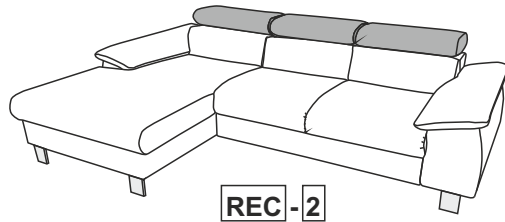
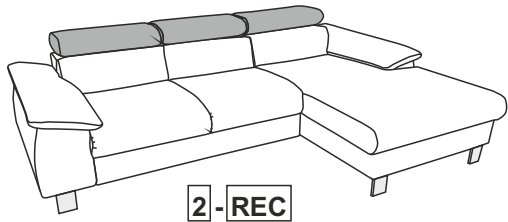

**1/2**

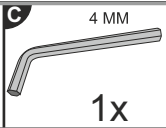
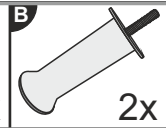
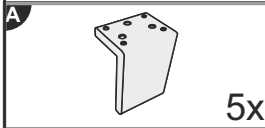

HARDWARE BAG /  
SACHET MATÉRIEL /  
ZUBEHÖRBEUTEL /  
SACCHETTI MATERIALE /  
BOLSA DE MATERIALES /  
WOREK MATERIALOWY

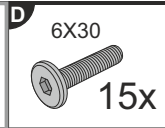

PRE-ASSEMBLED/  
PRÉ ASSEMBLÉ/  
VORMONTIERT/  
PREMONTATO/  
WSTĘPNIE ZAMONTOWANE

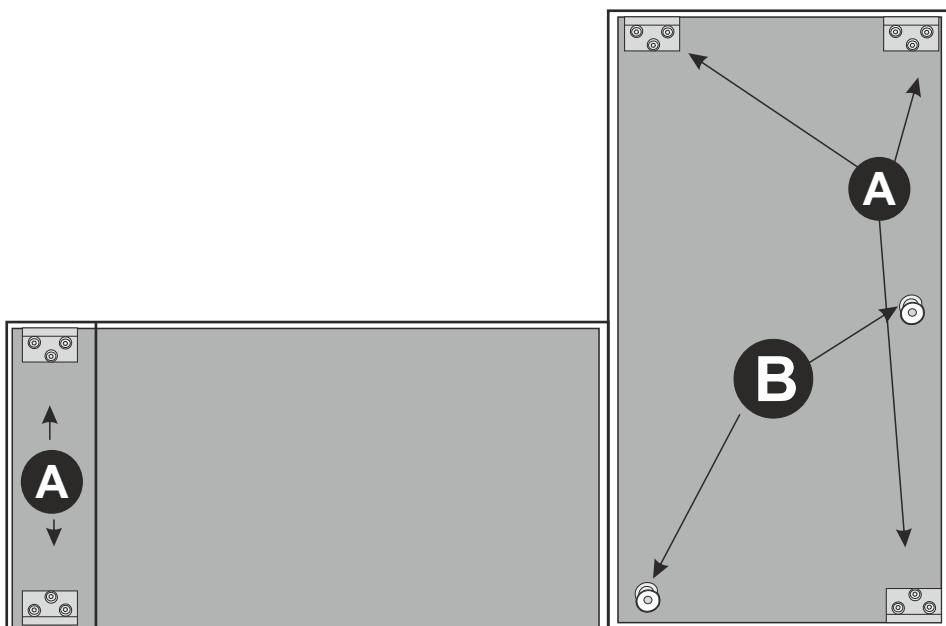
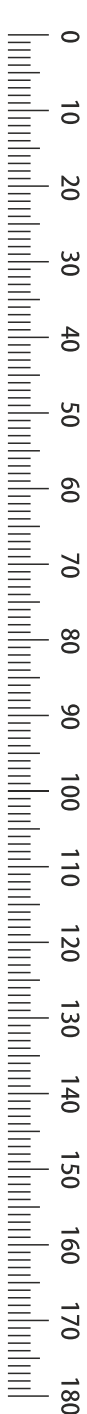
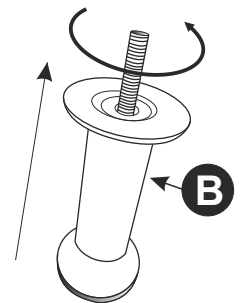
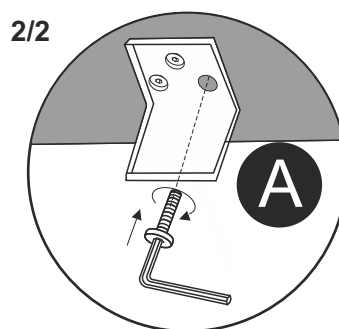
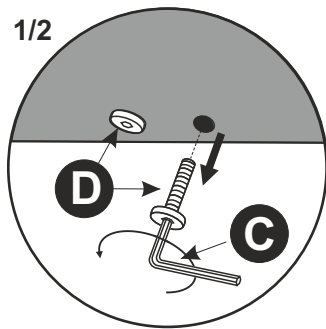
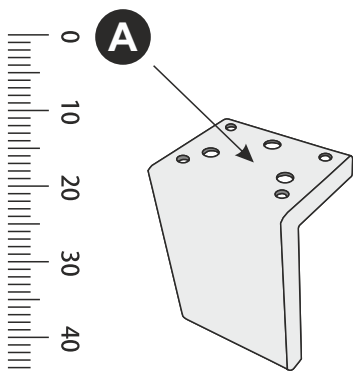

**2 X** | **20 MIN**

- |                                  |                               |
|----------------------------------|-------------------------------|
| (D) AUFBAUANLEITUNG              | (GB) ASSEMBLY INSTRUCTIONS    |
| (NL) HANDLEIDING VOOR DE MONTAGE | (PL) INSTRUKCJA MONTAŻU       |
| (TR) MONTAJ TALIMATI             | (RU) Инструкция по монтажу    |
| (RO) INSTRUCTIUNI DE ASAMBLARE   | (I) PROCEDURA DI ASSEMBLAGGIO |
| (F) INSTRUCTION D'ASSEMBLAGE     | (SK) POKYNY K MONTÁŽI         |
| (CZ) POKYNY K MONTÁŽI            | (HU) KÖZGYŰLÉS UTASÍTÁSOK     |
| (BG) ИНСТРУКЦИИ ЗА МОНТАЖ        | (SLD) ASSEMBLY INSTRUCTIONS   |
| (HR) NAPUTCI ZA MONTAŽU          | (S) MONTERINGSANVISNING       |
| (E) INSTRUCCIONES DE MONTAJE     | (LT) DIEGIMO INSTRUKCIJOS     |



„MICKY”

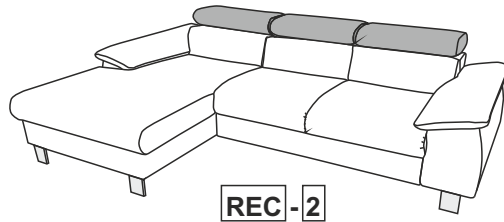
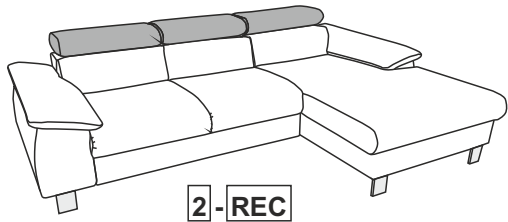

**2/2**

