



**T1** Bitte unbedingt ausfüllen!

Name \_\_\_\_\_

Strasse \_\_\_\_\_

Plz \_\_\_\_\_ Ort \_\_\_\_\_

Tel. \_\_\_\_\_

**T2** Sehr geehrte Kunden,  
wir freuen uns, dass Sie sich für ein Produkt aus dem Hause Pelipal entschieden haben. Sollte es trotz aller Bemühungen unsererseits, Ihnen ein qualitativ hochwertiges Möbelstück zu liefern, zu Fehlteilen kommen, schicken Sie bitte dieses ausgefüllte Blatt an  
Fax.: **+49 3443/434350**  
E-Mail: **ersatzteile@pelipal.de**  
Bitte beachten Sie, dass Bauteile über 800mm Länge und 350mm Breite direkt bei Ihrem Möbelhändler zu beanstanden sind. Zur Reklamationsbearbeitung ist es unbedingt erforderlich **die Artikelnummer des Schrankes**, welche auf dem Etikett ersichtlich ist und den Markt, wo das Möbel erworben wurde anzugeben. Ausserdem tragen Sie unten bitte die benötigte Stückzahl ein. Viel Spass mit Ihrem neuen Badmöbel! Ihr Pelipal Team

\_\_\_\_\_ - \_\_\_\_\_

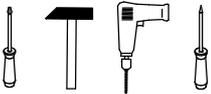

**T3** Für den Zusammenbau sind 2 Personen erforderlich.

**T4** Montage-Richtzeit 3 Stunden

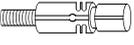
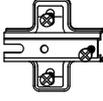
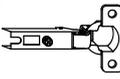
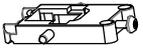
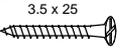
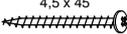
8 x a  DUEB-SMD-000005	Stück	8 x b  EXZENTER-000015	Stück	2 x c  ZPL-016X000	Stück	2 x d  TBD-26-115X00	Stück	1 x e  Griff	Stück
8 x f  TRAE-002-000010	Stück	2 x g  AUF-001-000060	Stück	2 x h  AUF-001-000020	Stück	6 x j  3.5 x 15 SCH-SPA-035X015	Stück	2 x k  Stück	Stück
10 x l  NAGEL-025X001	Stück	4 x m  3.5 x 25 SCH-SPA-035X025	Stück	2 x n  5 x 8 ADK-AL1-005X008	Stück	1 x o  TUER-DAEM-000010	Stück	1 x p  TUER-ADA-000010	Stück
1 x r  VBD-000020	Stück	1 x s  4.5 x 45 SCH-RDK-045X045	Stück	1 x t  4.0 x 15 SCH-RDK-040X015	Stück				

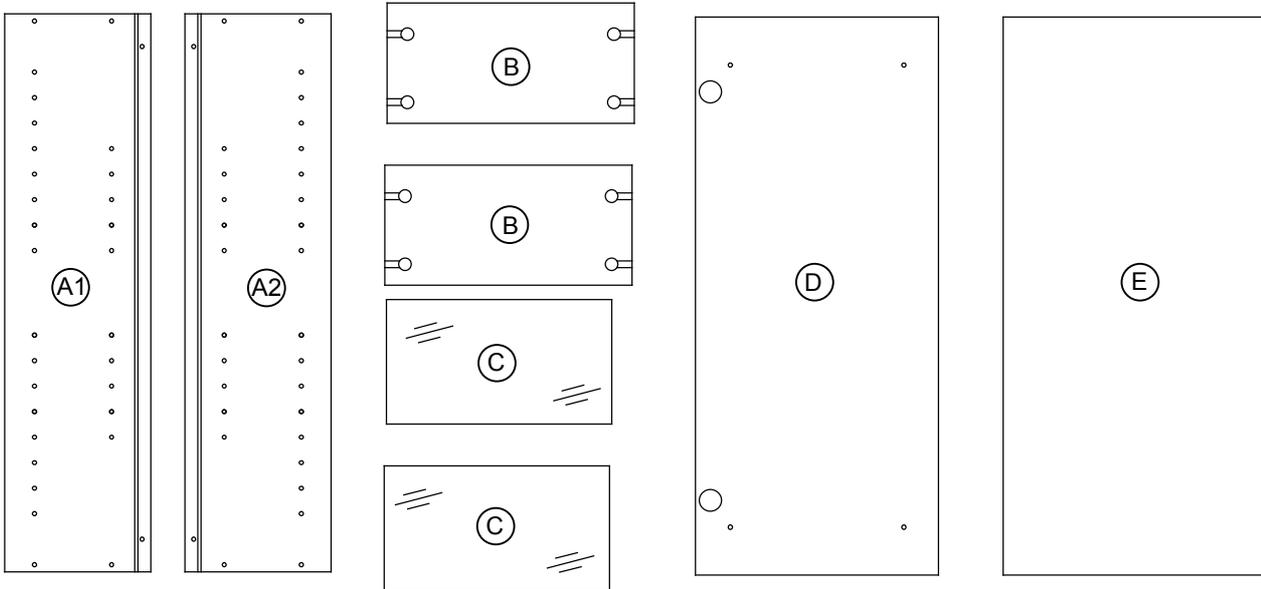

1.

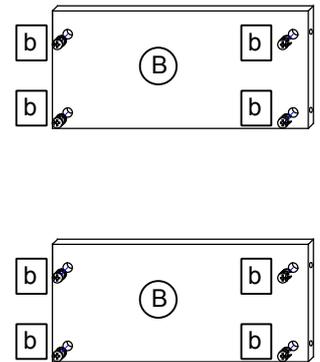
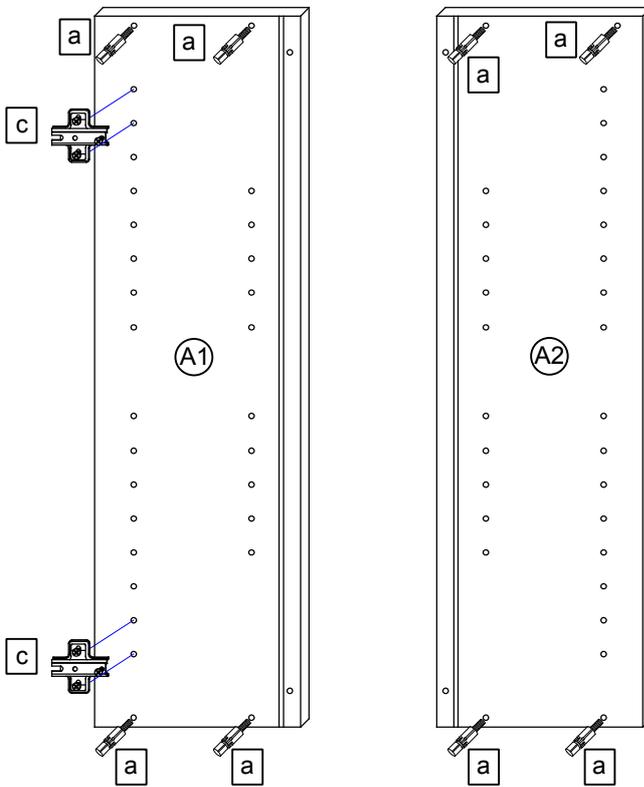
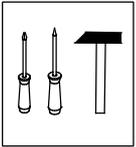

2.

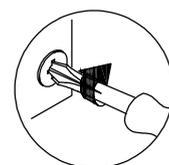
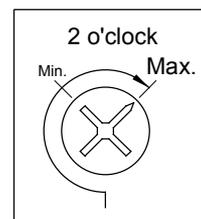
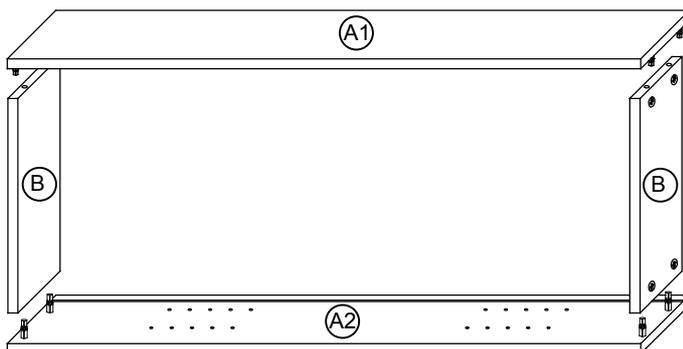

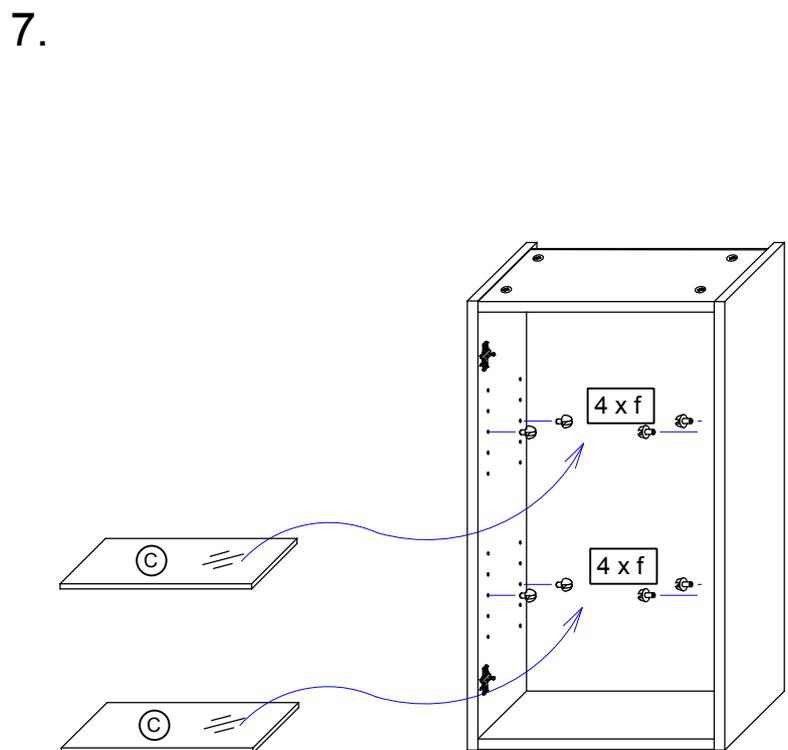
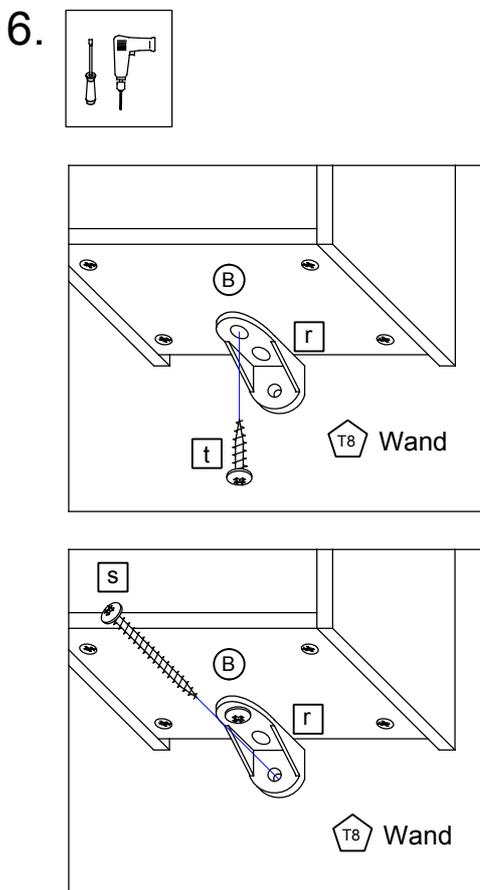
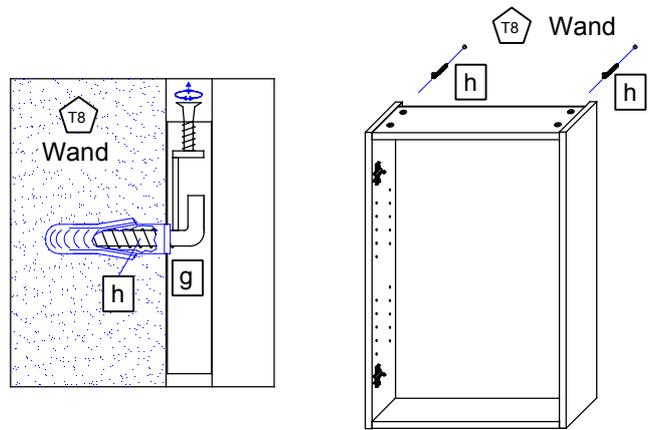
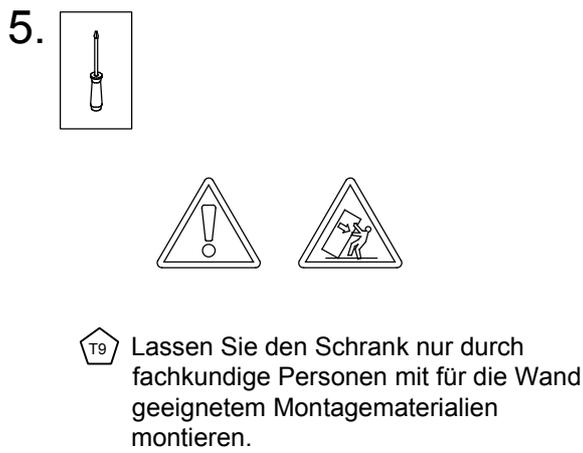
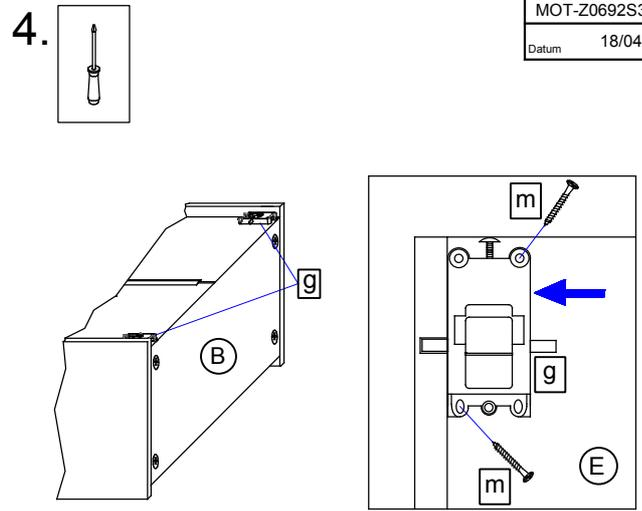
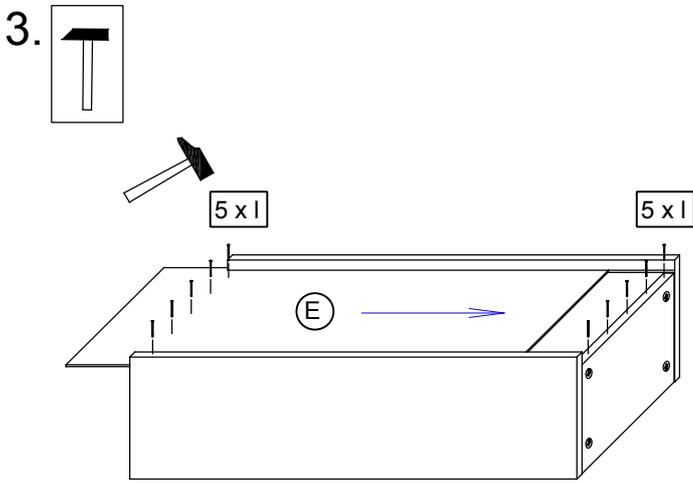

8.

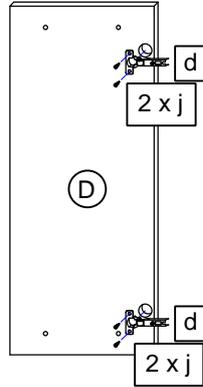
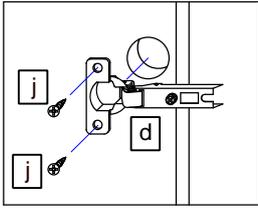
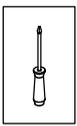

9.

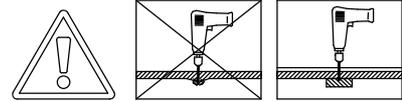
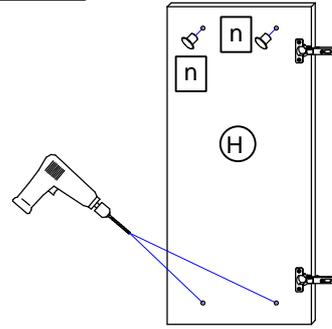

10.

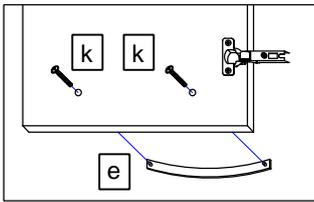
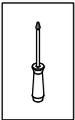

11.

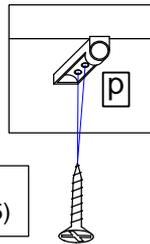
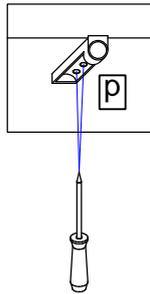
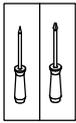

2 x j  
(3,5x15)

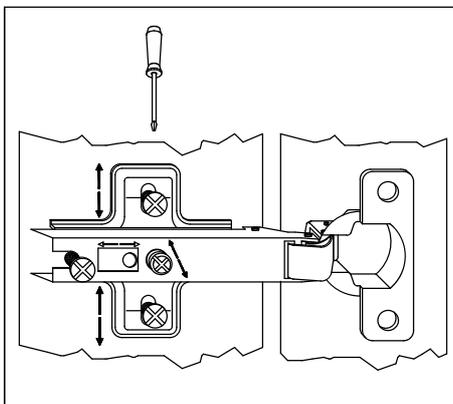
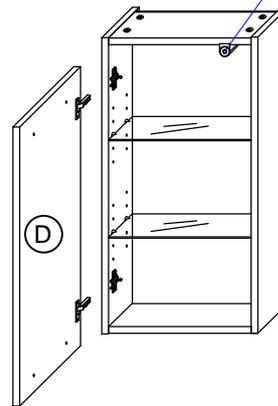
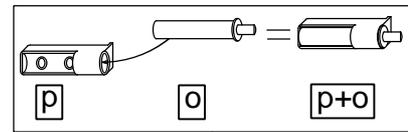

Bei Türmontage das Scharnier einhängen, bis Anschlag öffnen und anschließend festschrauben.

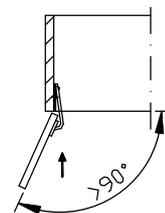

Das Möbel bitte nur mit einem feuchten Tuch reinigen.