

(D) Montageanleitung

(GB) Assembly instructions

(CZ) Montážní návod

(SK) Návod na montáž

(FR) Notice de montage

(IT) Istruzioni di montaggio

(HU) Szerelési útmutató

(RU) Инструкция по монтажу

(NL) Handleiding voor de montage

(PL) Instrukcja montażu

(TR) Montaj talimatı

(RU) Инструкция по монтажу



5 min

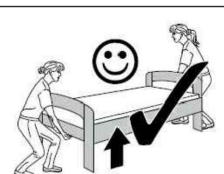
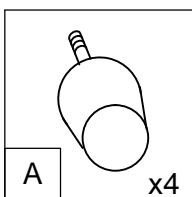
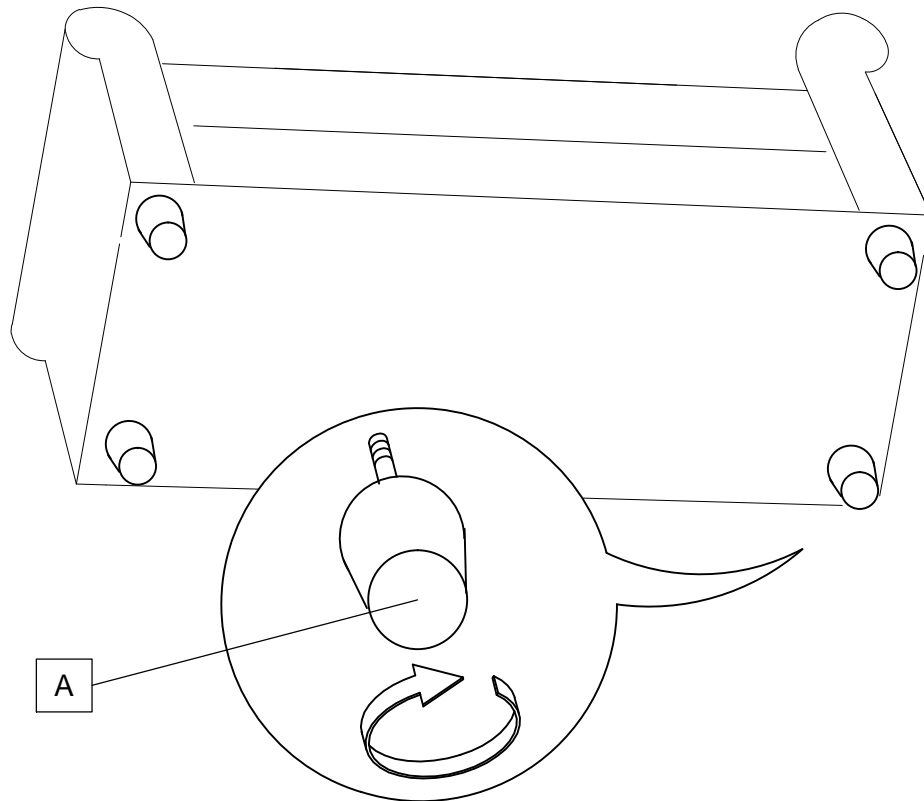
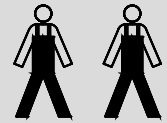

Service \* Assistenza \* Dienstverlening \* Serwis \* Servis \* Szerviz \* Сервисная служба

Name \* Nom \* Nome \* Naaz \* Nazwa \* Jméno  
 Názov \* Név \* Denumire \* Isim \* Название

"LORD"

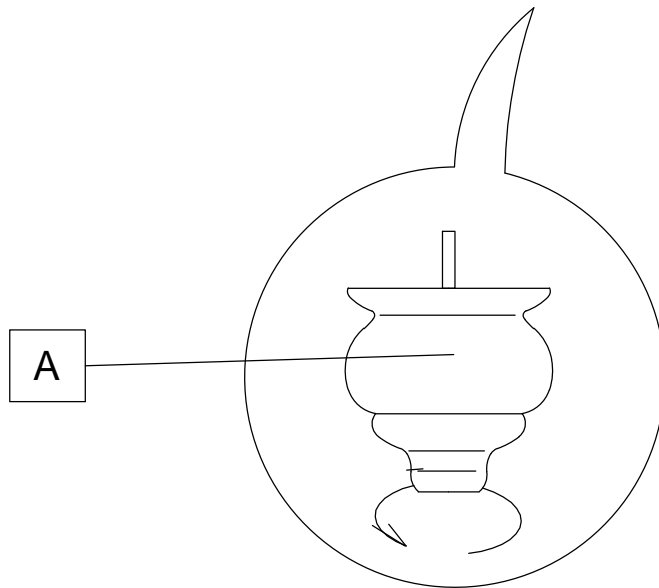
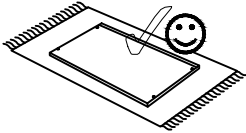
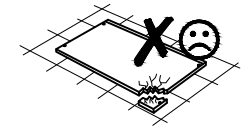
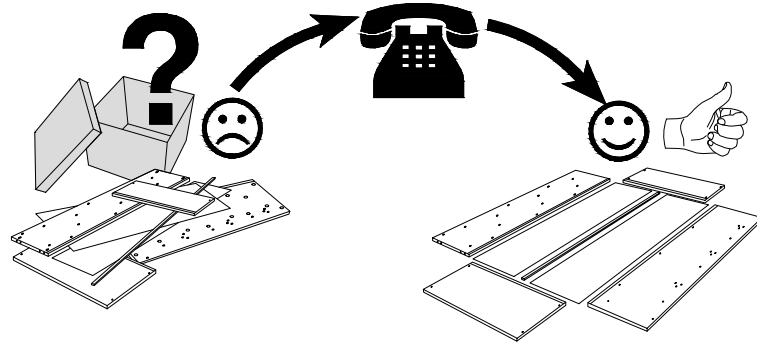
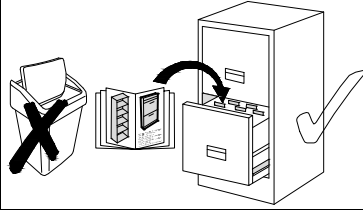

<div data-bbox="140 1951 188 1995" data-label="Text"> <p>A</p> </div> <div data-bbox="180 2011 288 2056" data-label="Text"> <p>X....</p> </div>	<div data-bbox="320 1951 368 1995" data-label="Text"> <p>B</p> </div> <div data-bbox="363 2011 472 2056" data-label="Text"> <p>X....</p> </div>
---	---