



D Montageanleitung

F Notice de montage

NL Handleiding voor de montage

CZ Monzážní návod

HU Szerelési útmutató

TR Montaj talimatı

GB Assembly instructions

I Istruzione di montaggio

PL Instrukcja montaży

SK Návod na montáž

RO Instrucțiuni de montaj

RU ИНСТРУКЦИЯ ПО МОНТАЖУ

Art. Nr. 3092

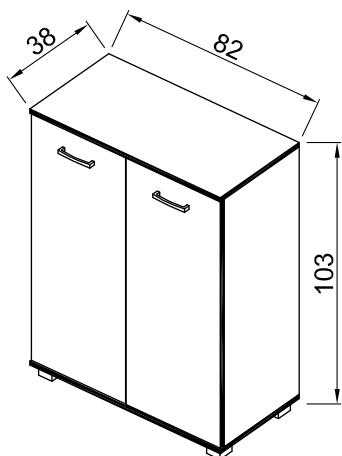

Art. Nr. 3092

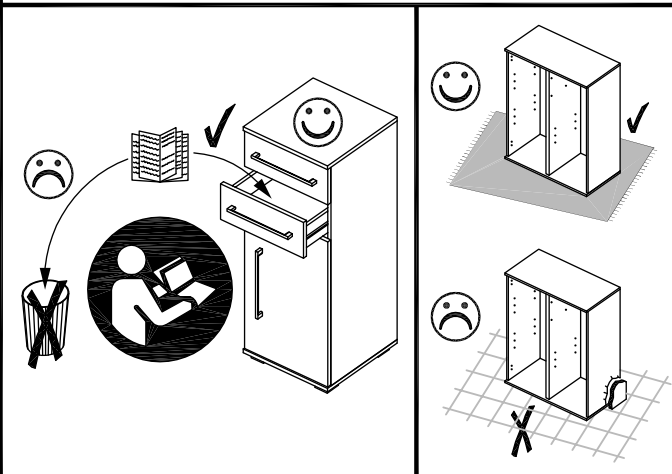
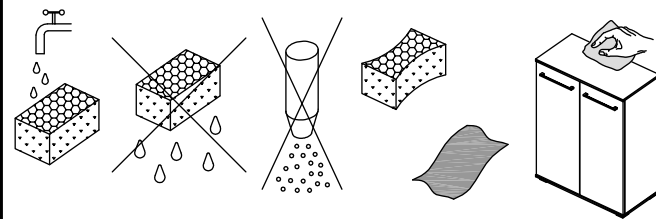
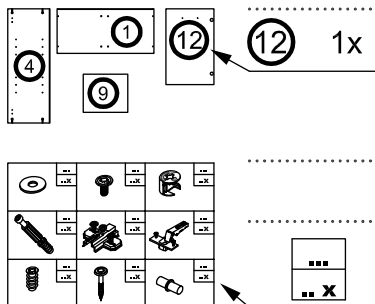

	102 10x		142 8x
3,5 x 35		Ø 15 x 11,5	
	143 8x		148 4x
6 x 44			
	528 5x		535 4x
	537 2x		906 28x
		2,7 x 20	
	909 4x		916 8x
3 x 12			
	990 2x		

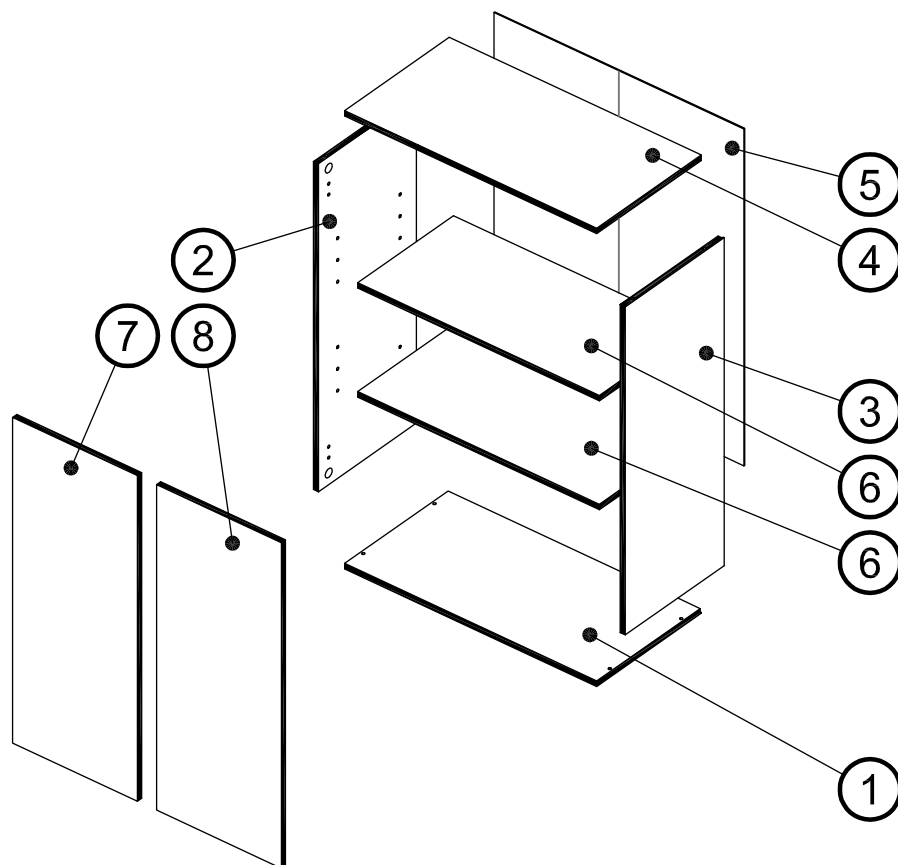

1

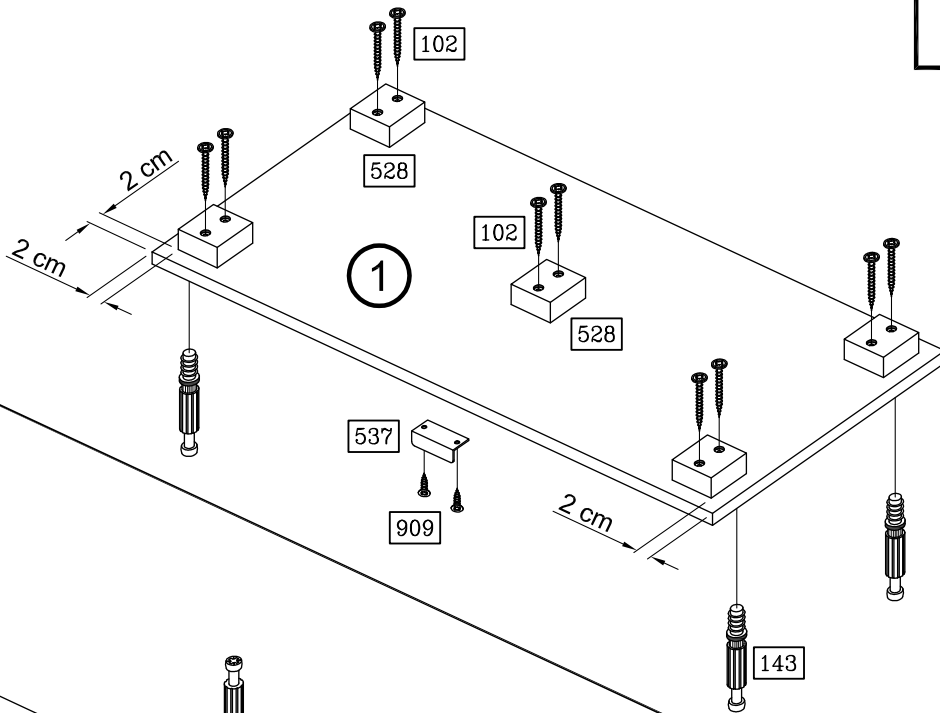
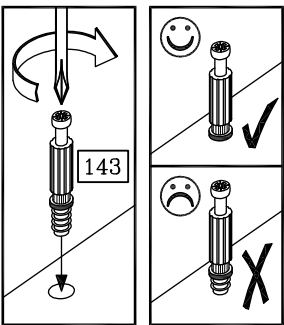

2

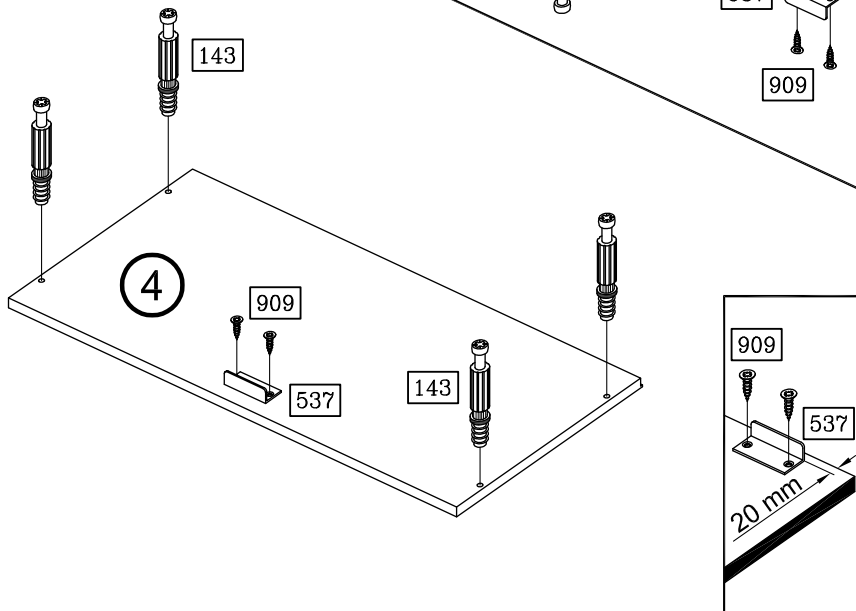

3

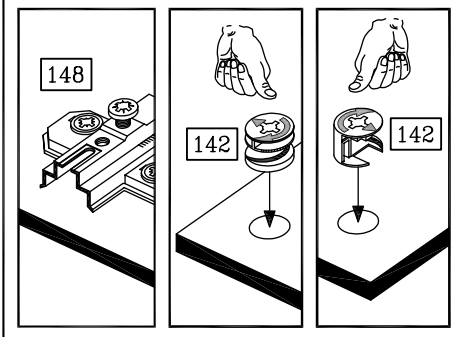
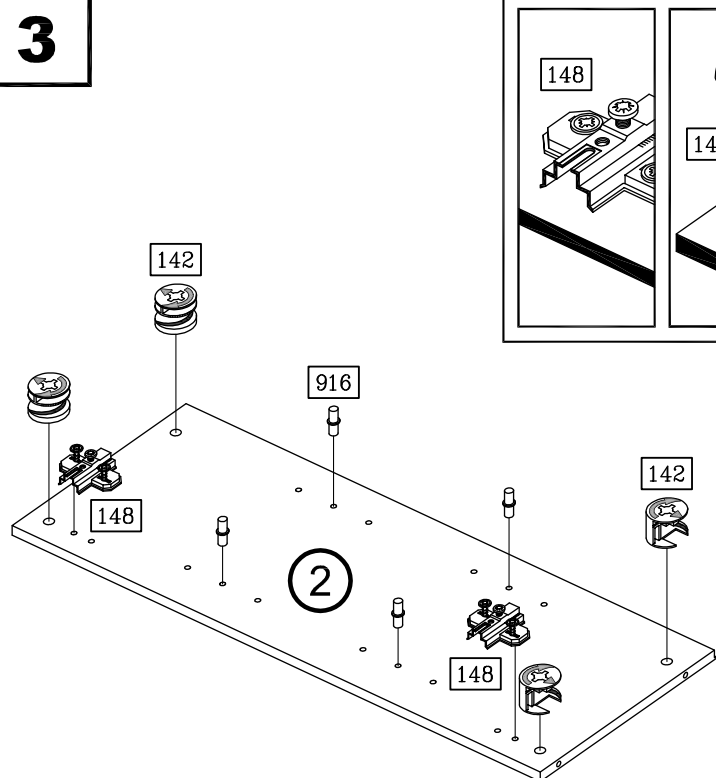

4

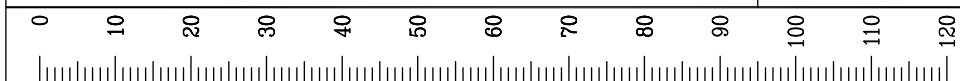
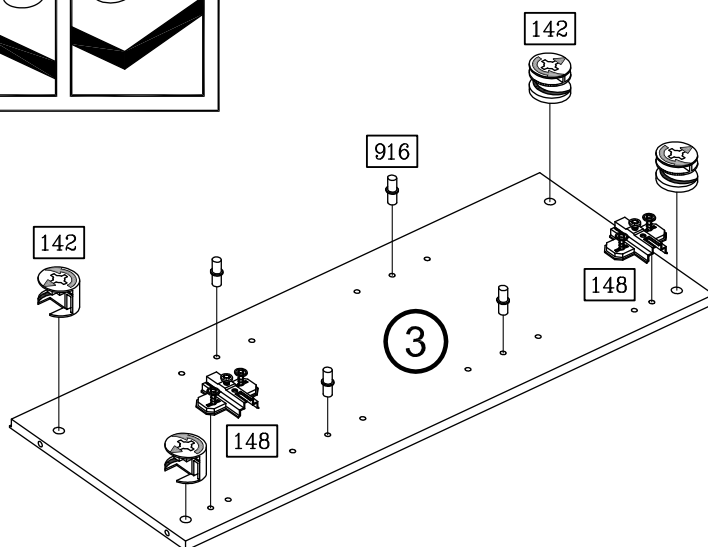

5

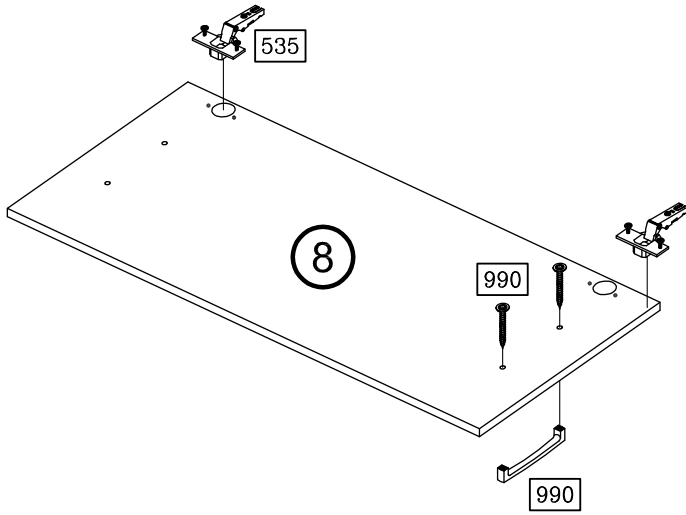

6

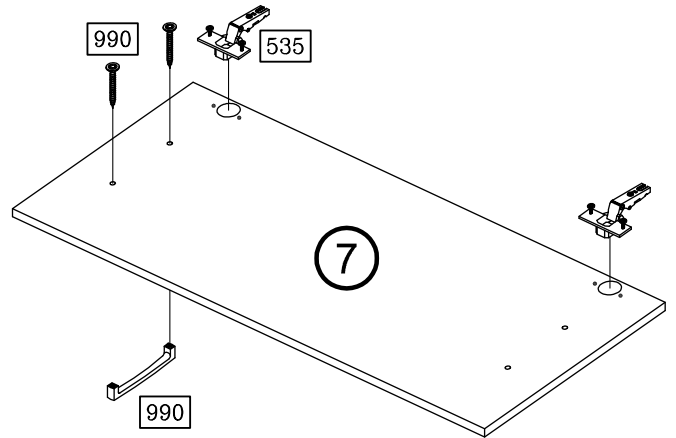

7

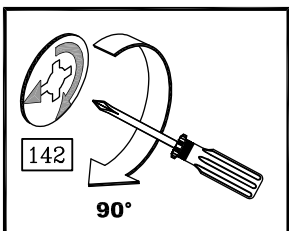
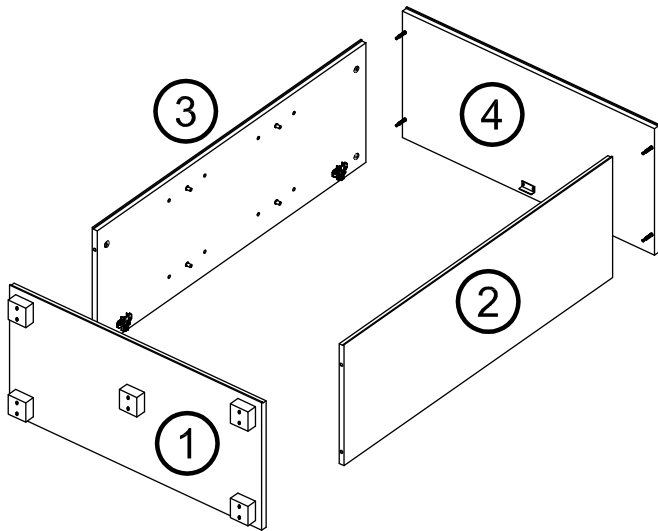

8

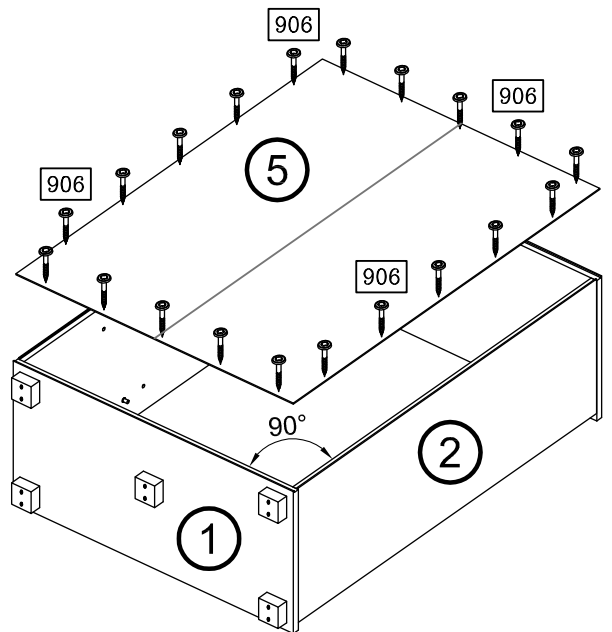
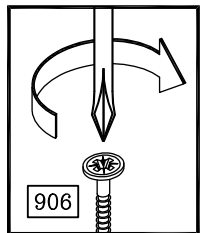

9

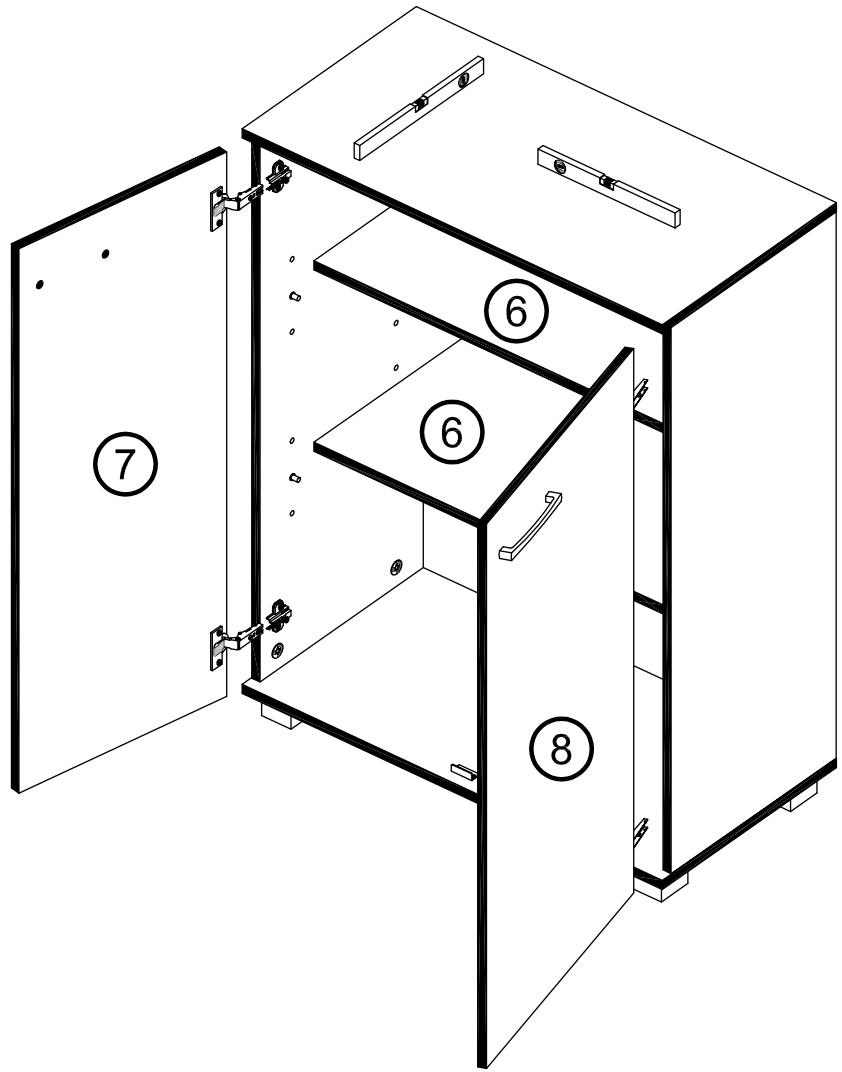
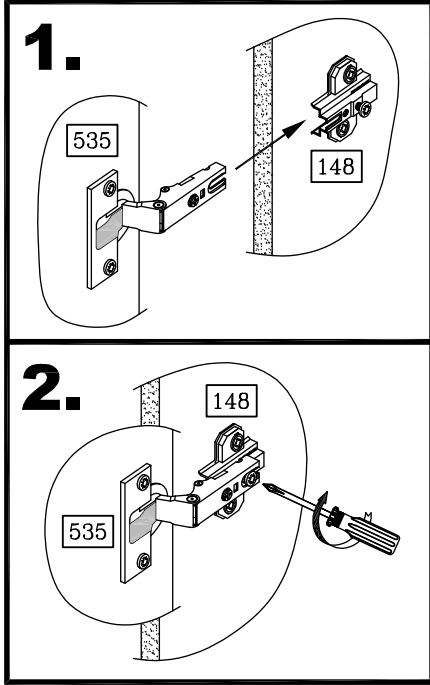

10

