

(D) Montageanleitung

(GB) Assembly instructions

(CZ) Montážní návod

(SK) Návod na montáž

(FR) Notice de montage

(IT) Istruzioni di montaggio

(HU) Szerelési útmutató

(RU) Instrucțiuni de montaj

(NL) Handleiding voor de montage

(PL) Instrukcja montażu

(TR) Montaj talimatı

(RU) Инструкция по монтажу



5 min

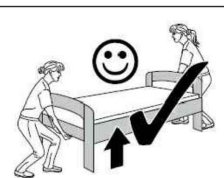
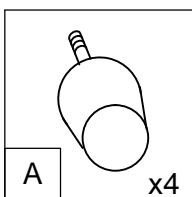
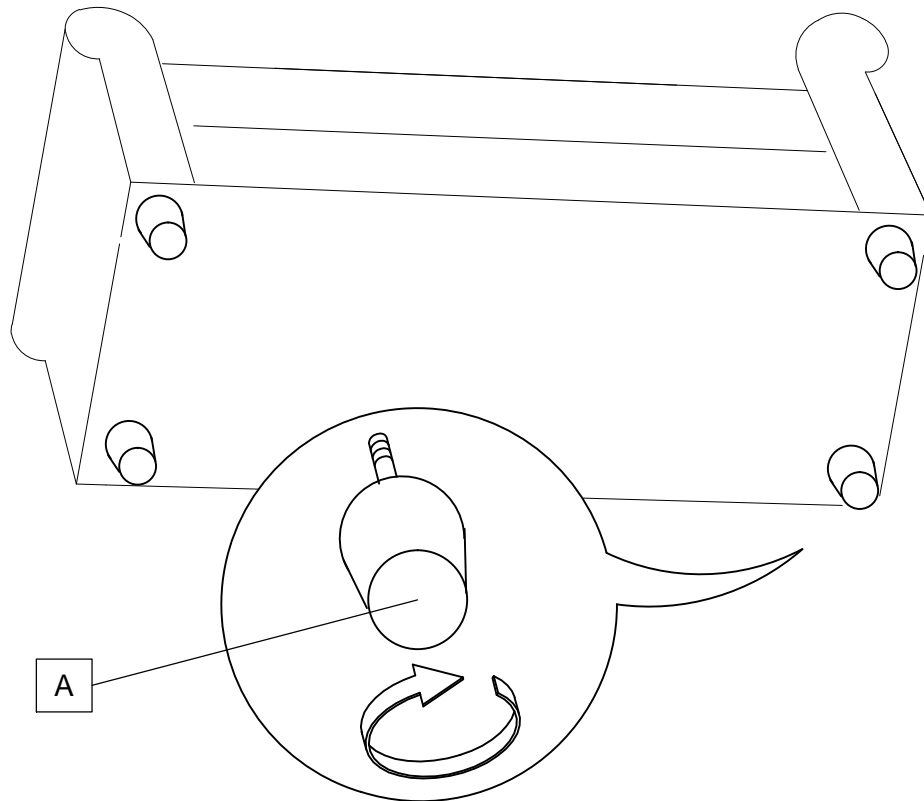
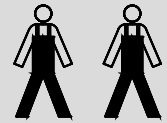

Service * Assistenza * Dienstverlening * Serwis * Servis * Szerviz * Сервисная служба

Name * Nom * Nome * Naaz * Nazwa * Jméno
 Názov * Név * Denumire * Isim * Название

"LORD"

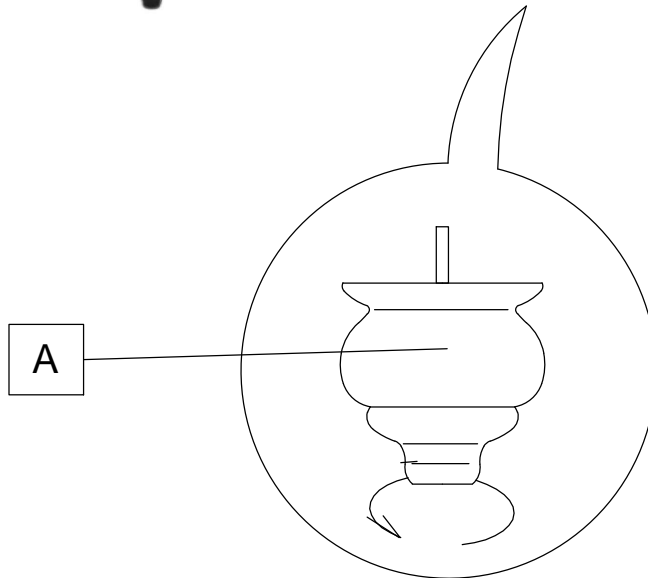
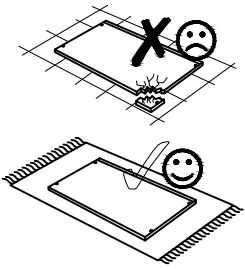
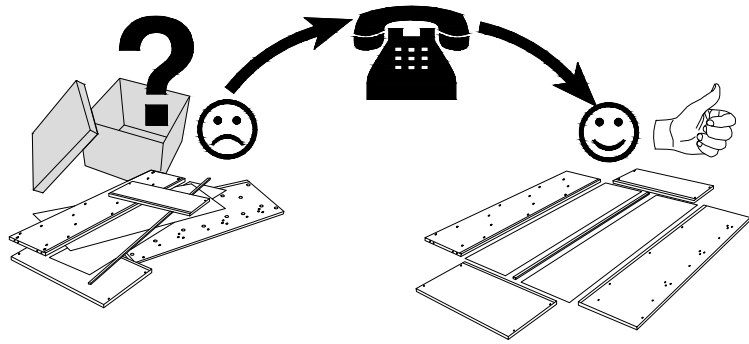
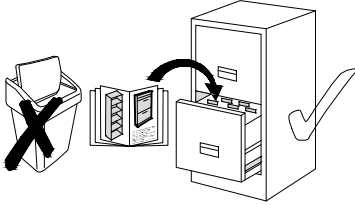

<p>A</p> <p>X....</p>	<p>B</p> <p>X....</p>
-----------------------	-----------------------