

980423

1.

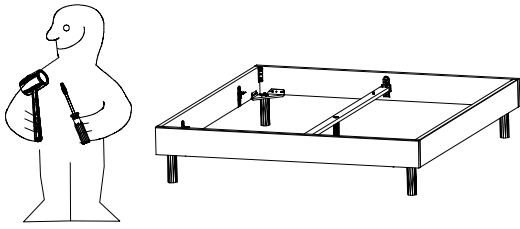

2.

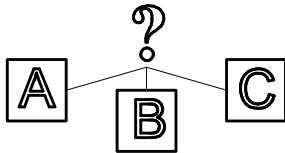
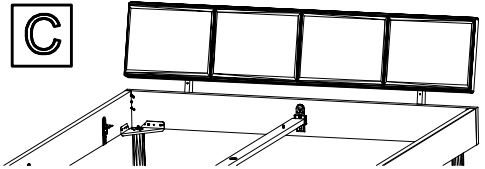
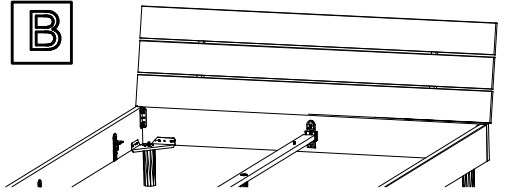
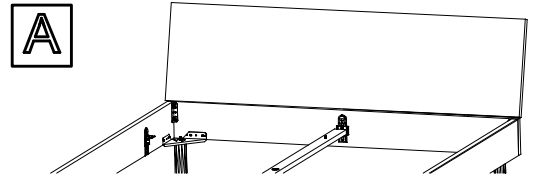
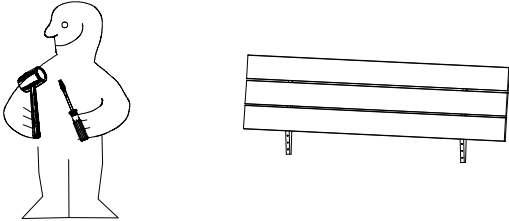

A

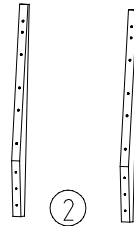
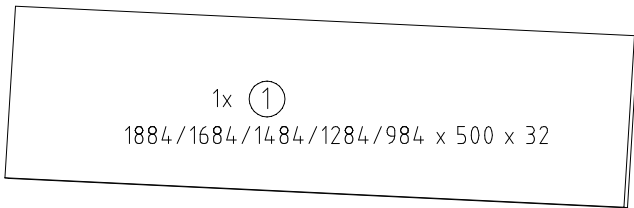

B

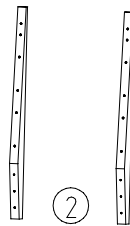
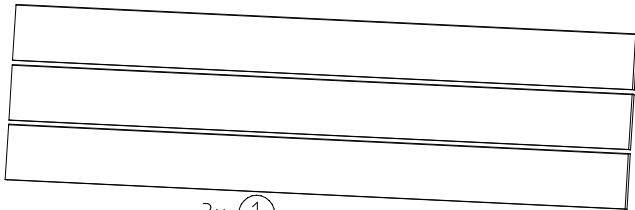

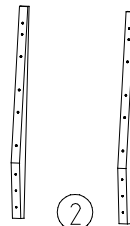
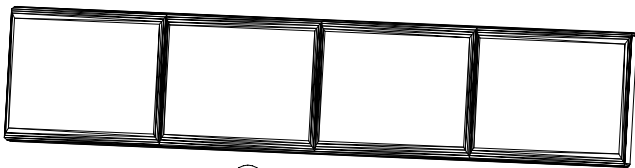

C



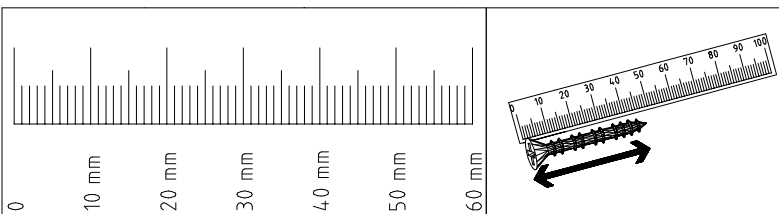
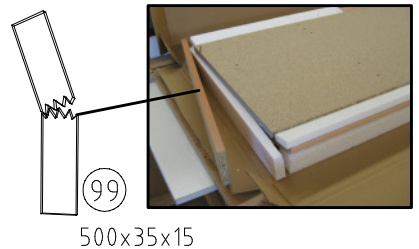
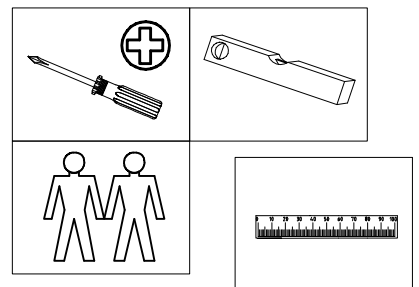

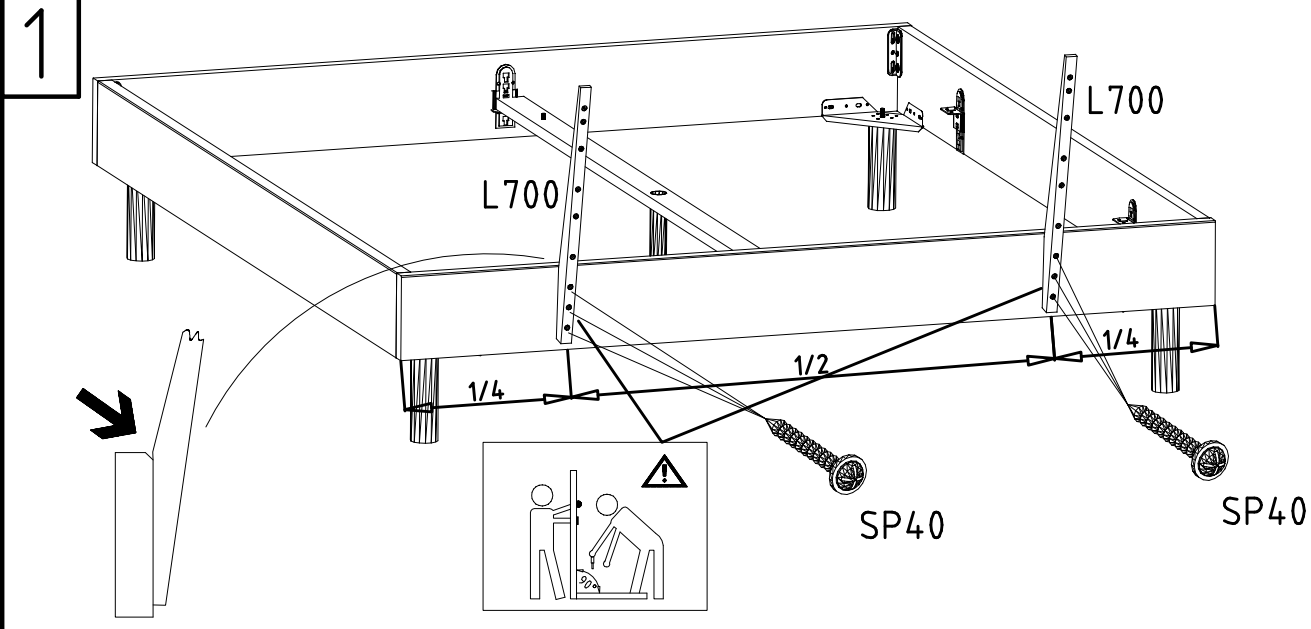
o16 	A B	2x
111 004 4,0 x 15 mm G23 	A B	8x
121 110 121 115 SP40 	6x	
4 X 40 mm		
4 X 27mm SP27 	A	B
122620	6x	12x10x



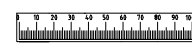

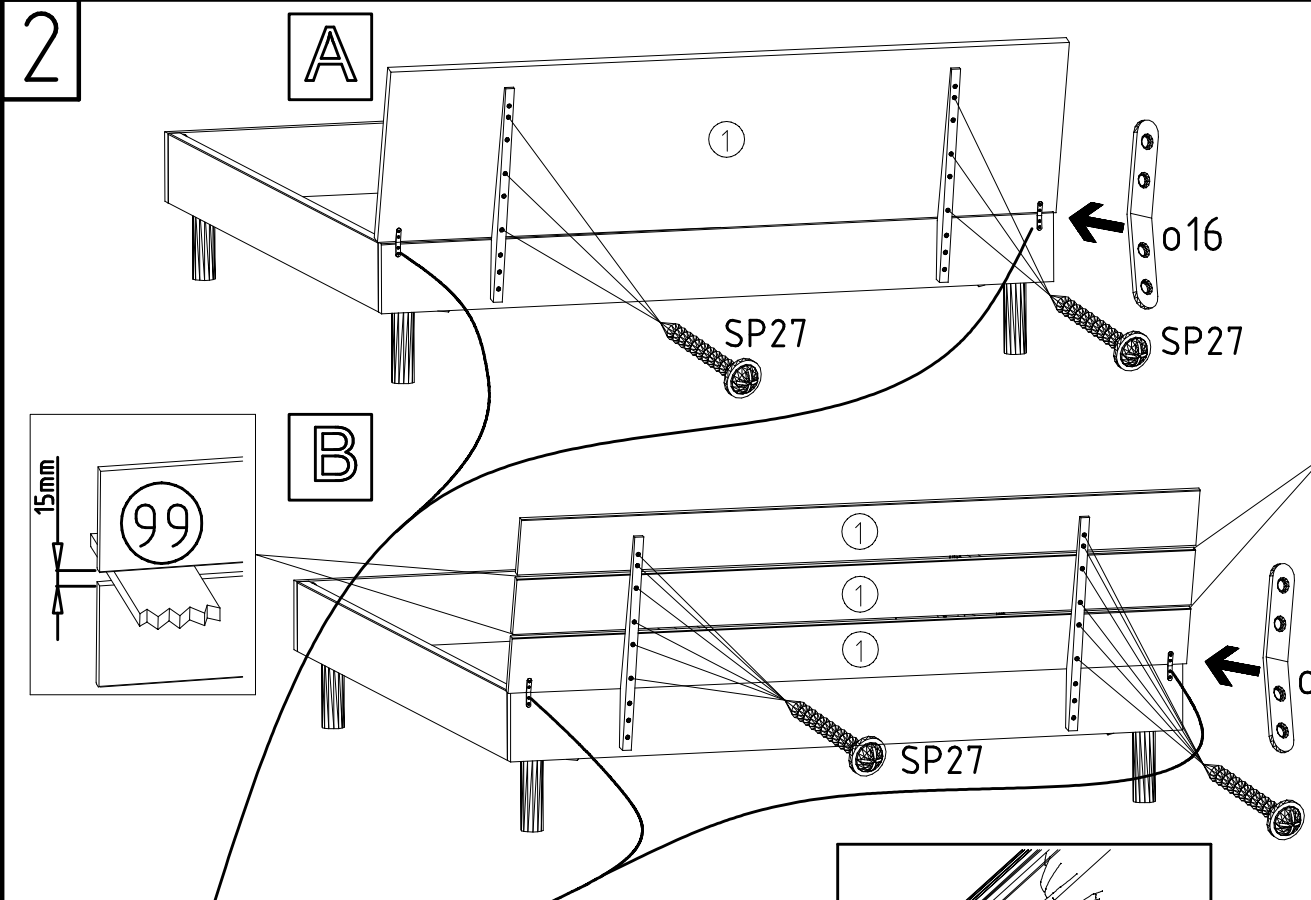
121 115 **SP40**

 4 X 40 mm



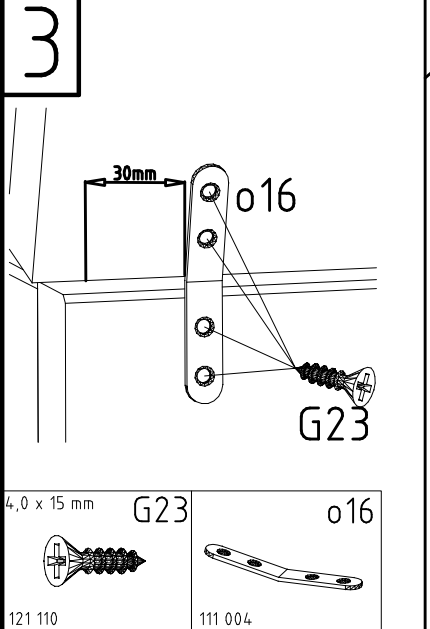
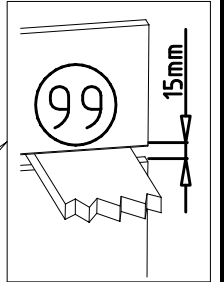

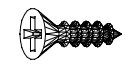
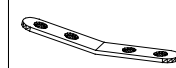
SP27
 4 X 27mm

 122620



4,0 x 15 mm **G23** **o16**

 121 110 111 004