

A	B	C (mm)			D
1	F27-405	1669	66	15	2/3
2	F27-406	1669	66	15	2/3
3	F27-902	1878	847	2,5	1/3
4	F52-101	1950	549	15	1/3
5	F52-102	1950	520	15	1/3
6	F52-103	1853	421	15	1/3
7	F52-301	827	420	15	2/3
8	F52-302	1669	519	15	2/3
9	F52-303	1669	504	15	2/3
10K	F52-507	861	950	15	3/3
10D	F52-507	861	950	15	3/3
11K	F52-508	861	950	15	3/3
11D	F52-508	861	950	15	3/3
12	dr-821	821	22	15	2/3

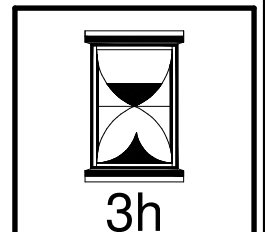

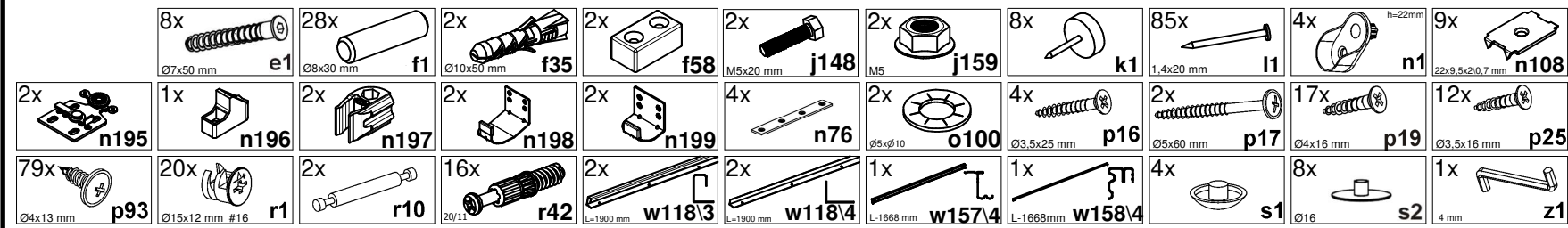
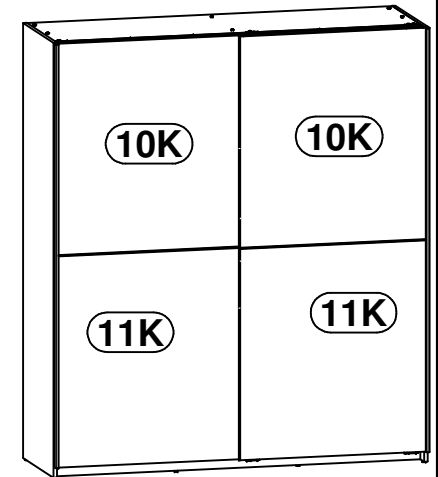
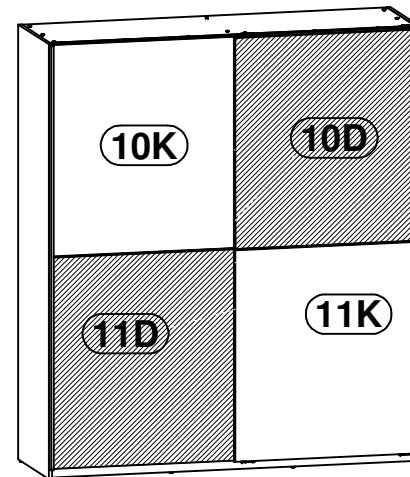
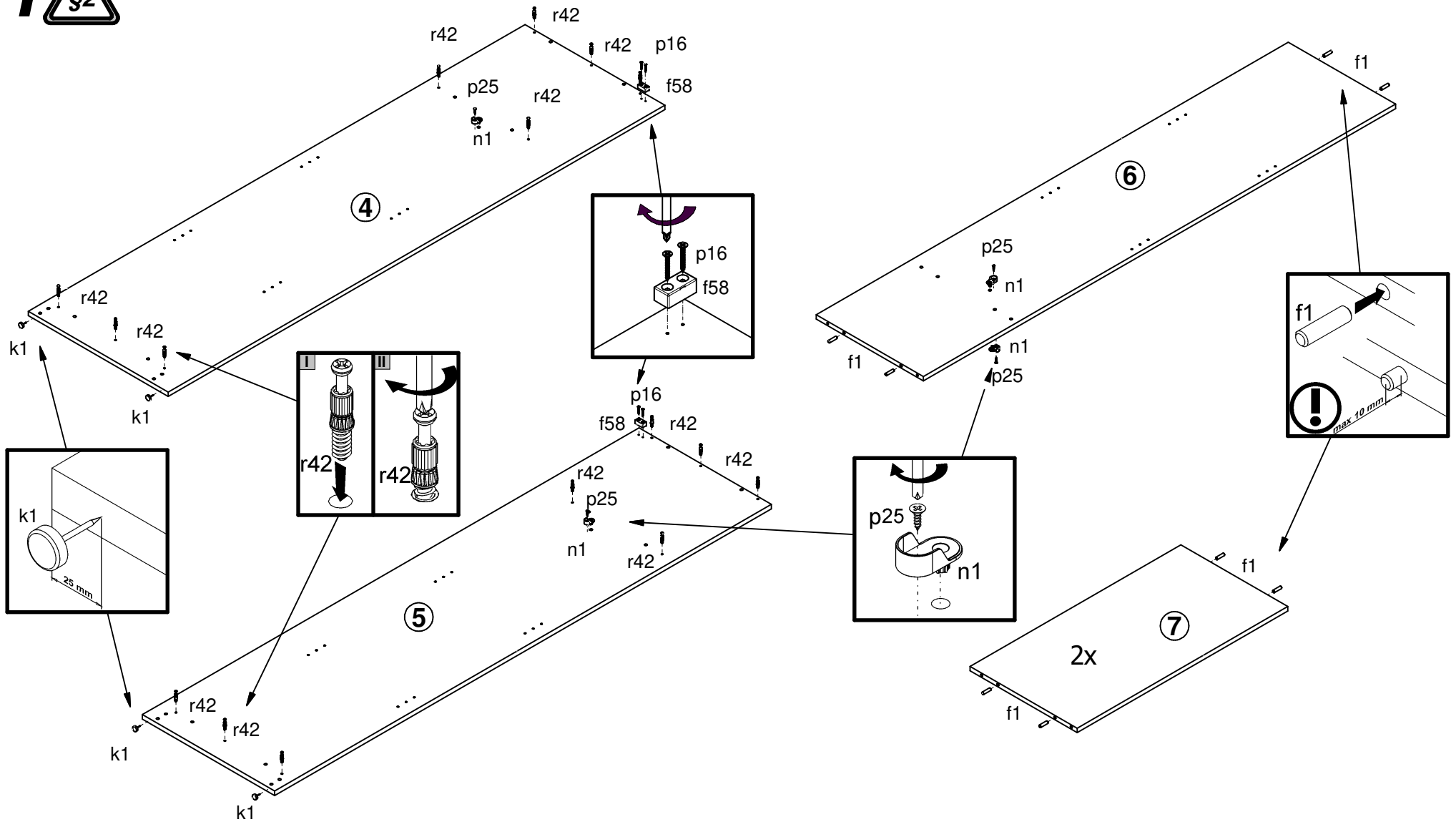

- 12x f1
Ø8x30 mm
- 2x f58
- 4x k1
- 4x n1
h=22mm
- 4x p16
Ø3.5x25 mm
- 4x p25
Ø3.5x16 mm
- 16x r42
20/11

2

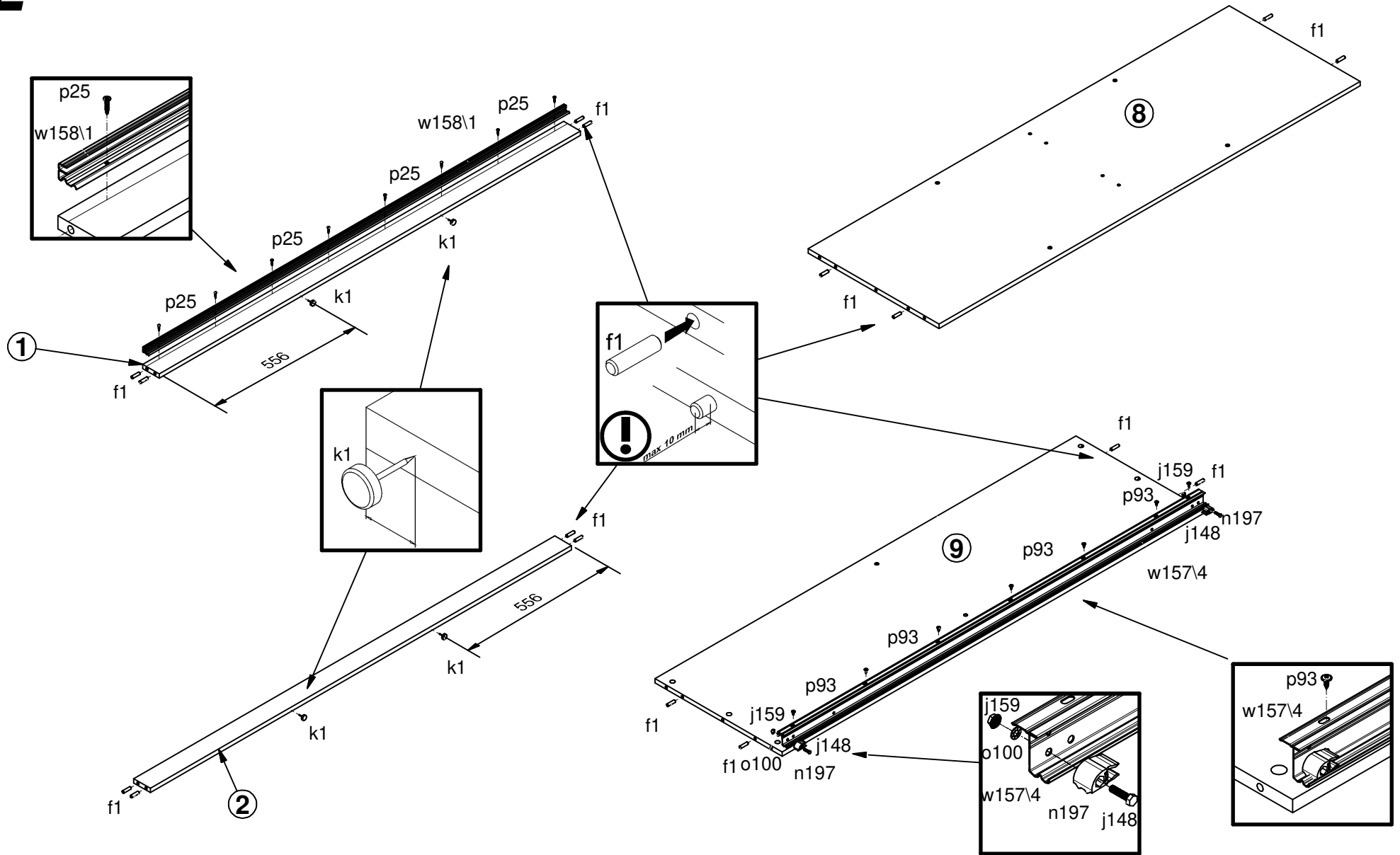

- | | | | | | | | | | |
|-----------------------|----------|------------|------------------------|------------------|----------------------|-------------------------|-----------------------|---------------------------|--------------------------|
| 16x
Ø8x30 mm
f1 | 4x
k1 | 2x
n197 | 2x
M5x20 mm
j148 | 2x
M5
j159 | 2x
Ø5xØ10
o100 | 8x
Ø3.5x16 mm
p25 | 7x
Ø4x13 mm
p93 | 1x
L-1668 mm
w157\4 | 1x
L-1668mm
w158\4 |
|-----------------------|----------|------------|------------------------|------------------|----------------------|-------------------------|-----------------------|---------------------------|--------------------------|

3

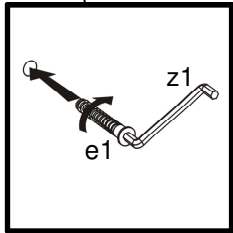
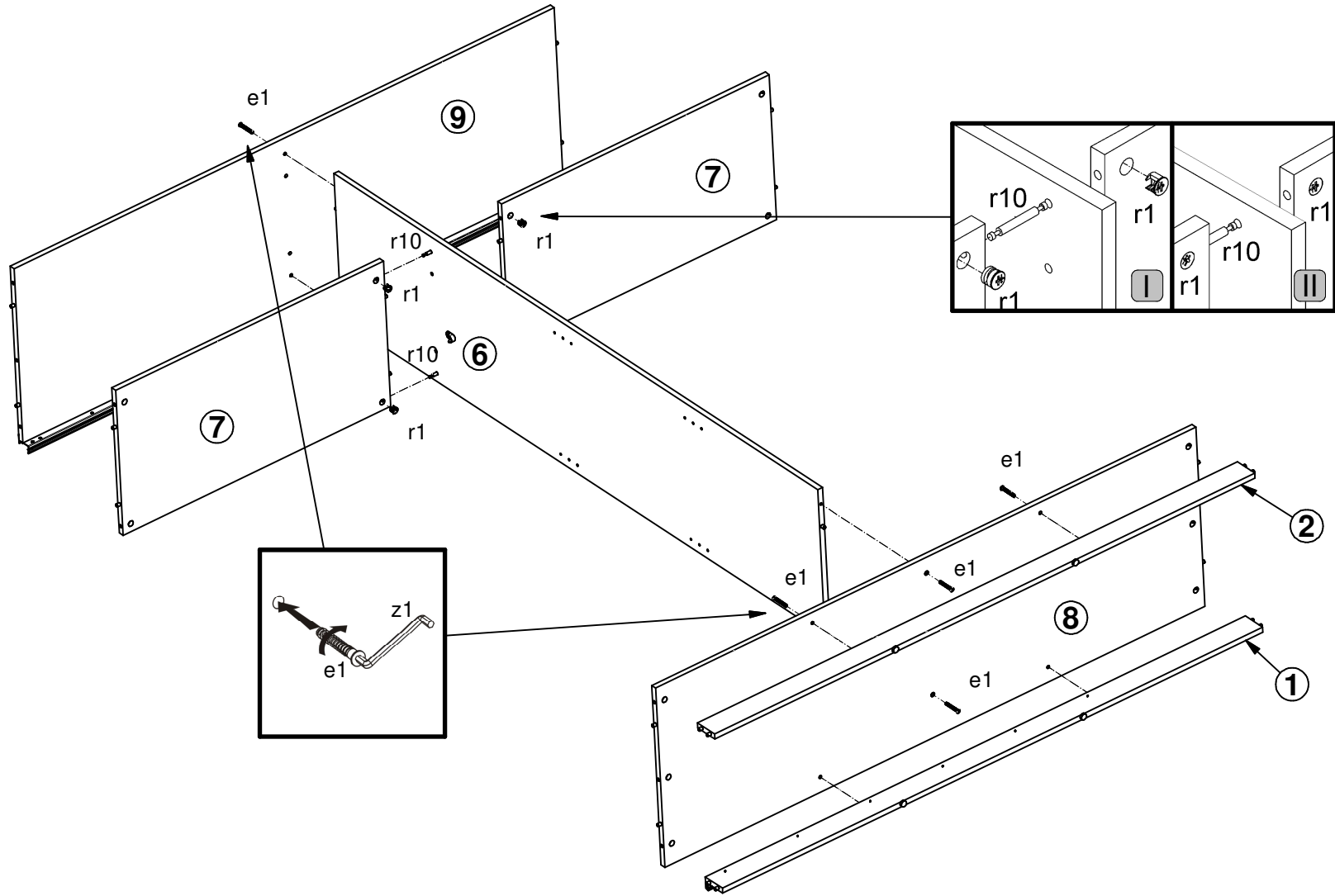

- 8x e1 Ø7x50 mm
- 4x r1 Ø15x12 mm #16
- 2x r10

4

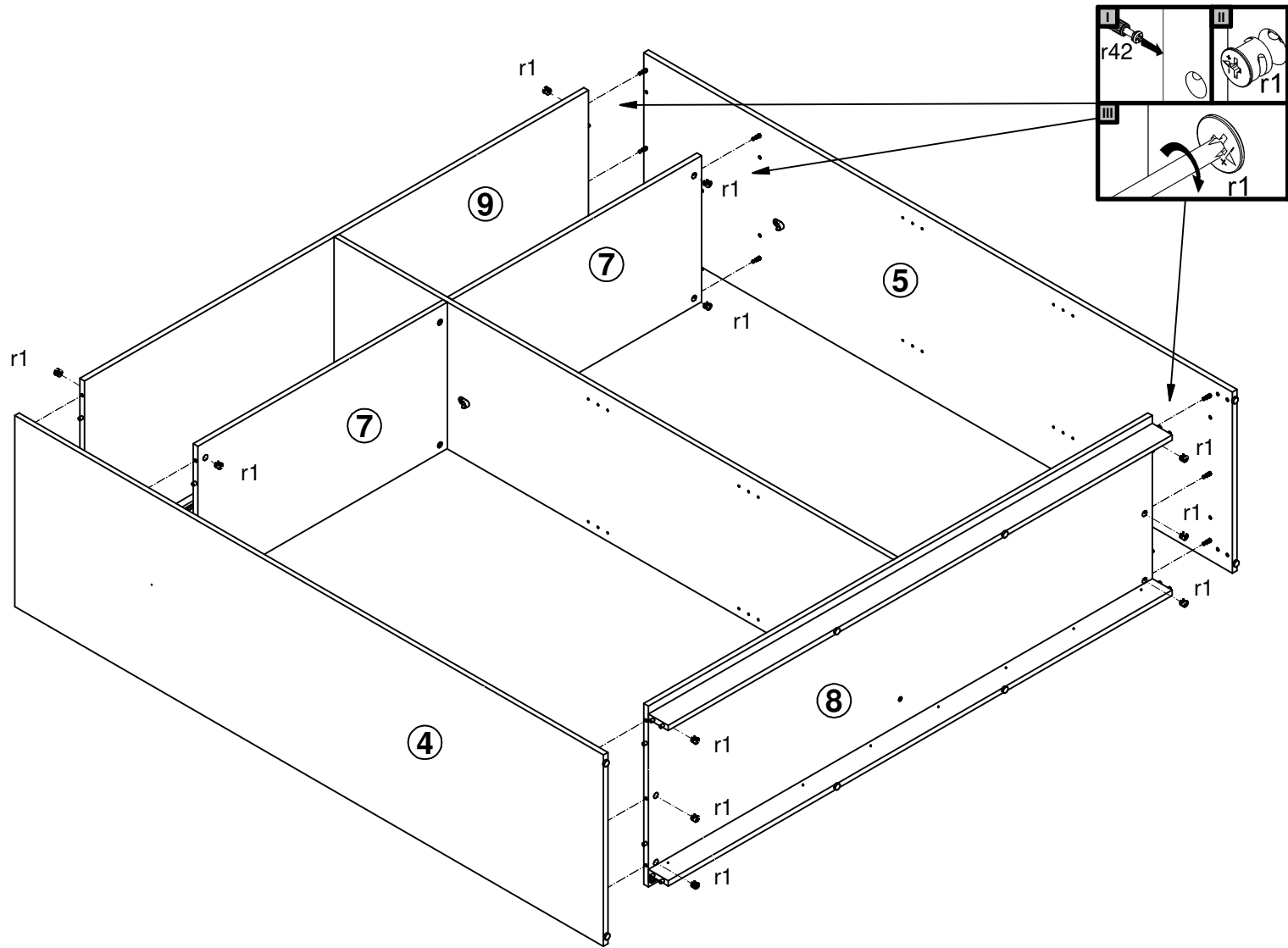

5

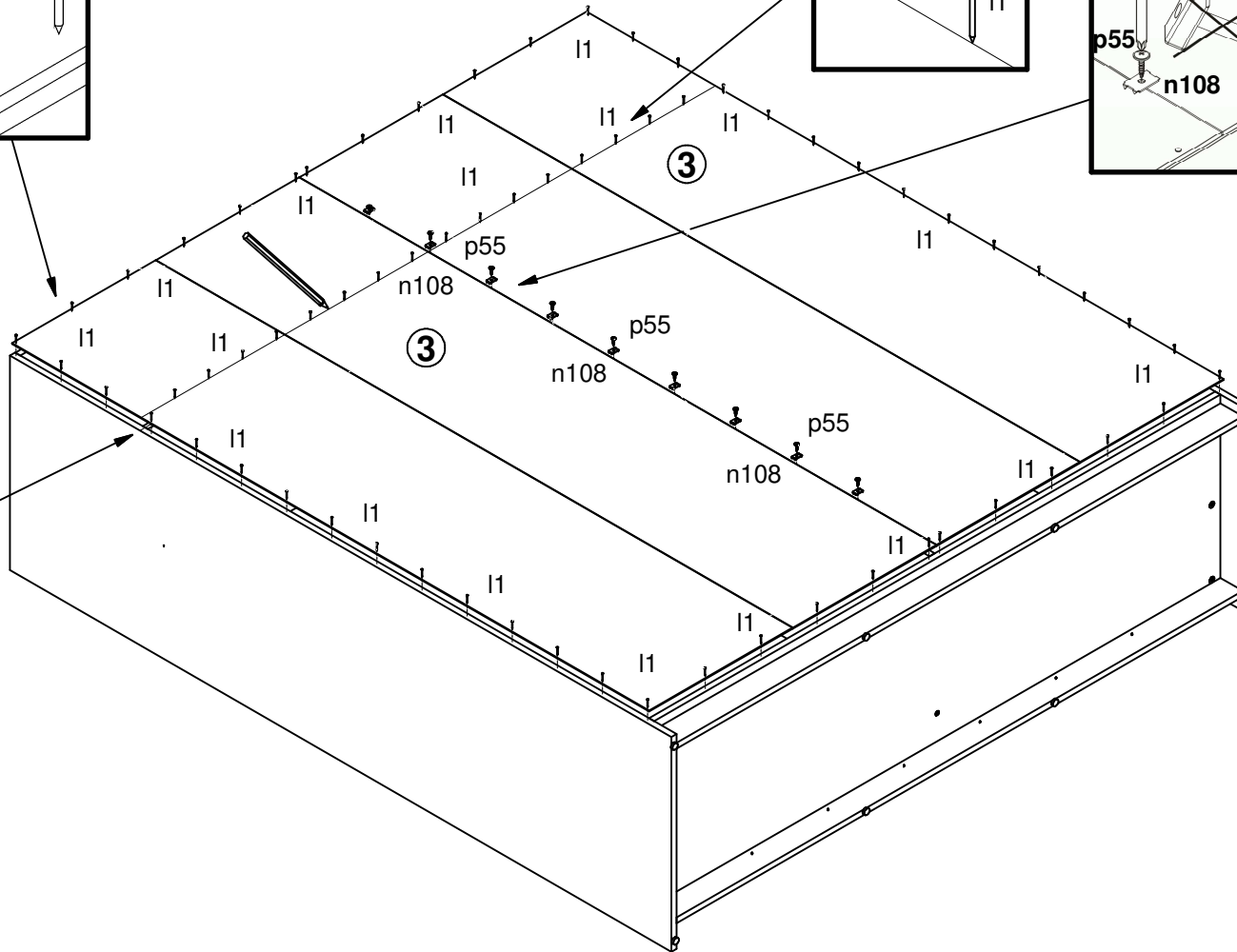
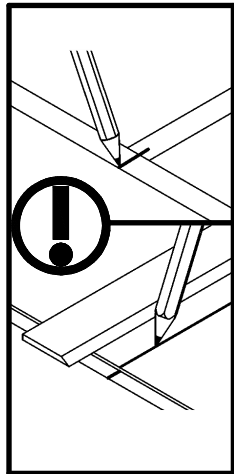
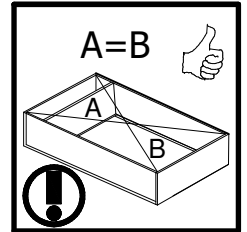
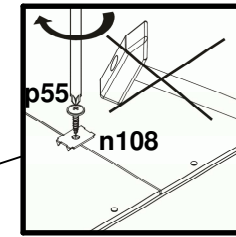
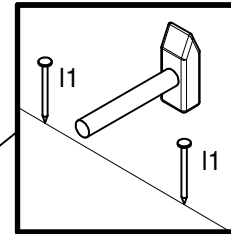
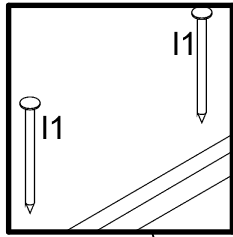

- 85x  l1
1.4x20 mm
- 9x  n108
22x9,5x20,7 mm
- 9x  p55
Ø2,9x16 mm

6

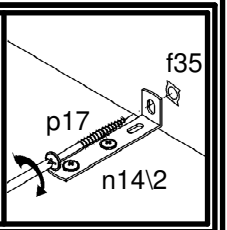
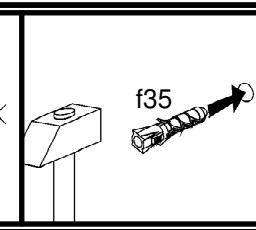
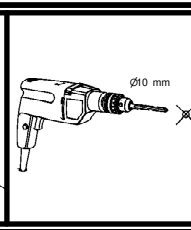
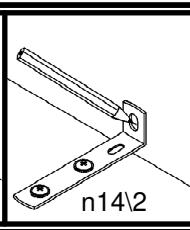
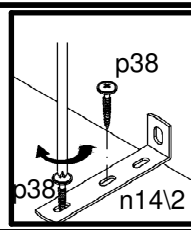
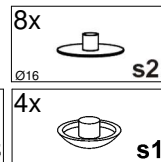
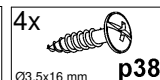
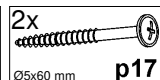
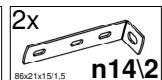
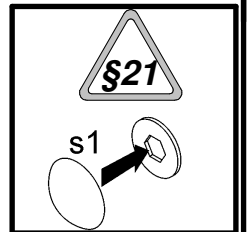
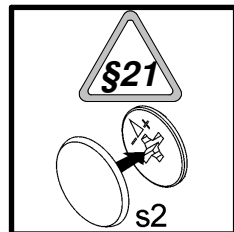
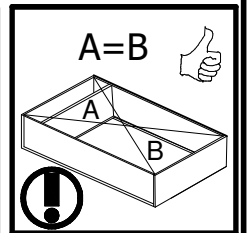
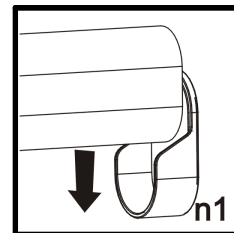
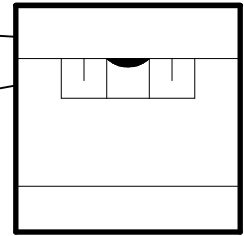
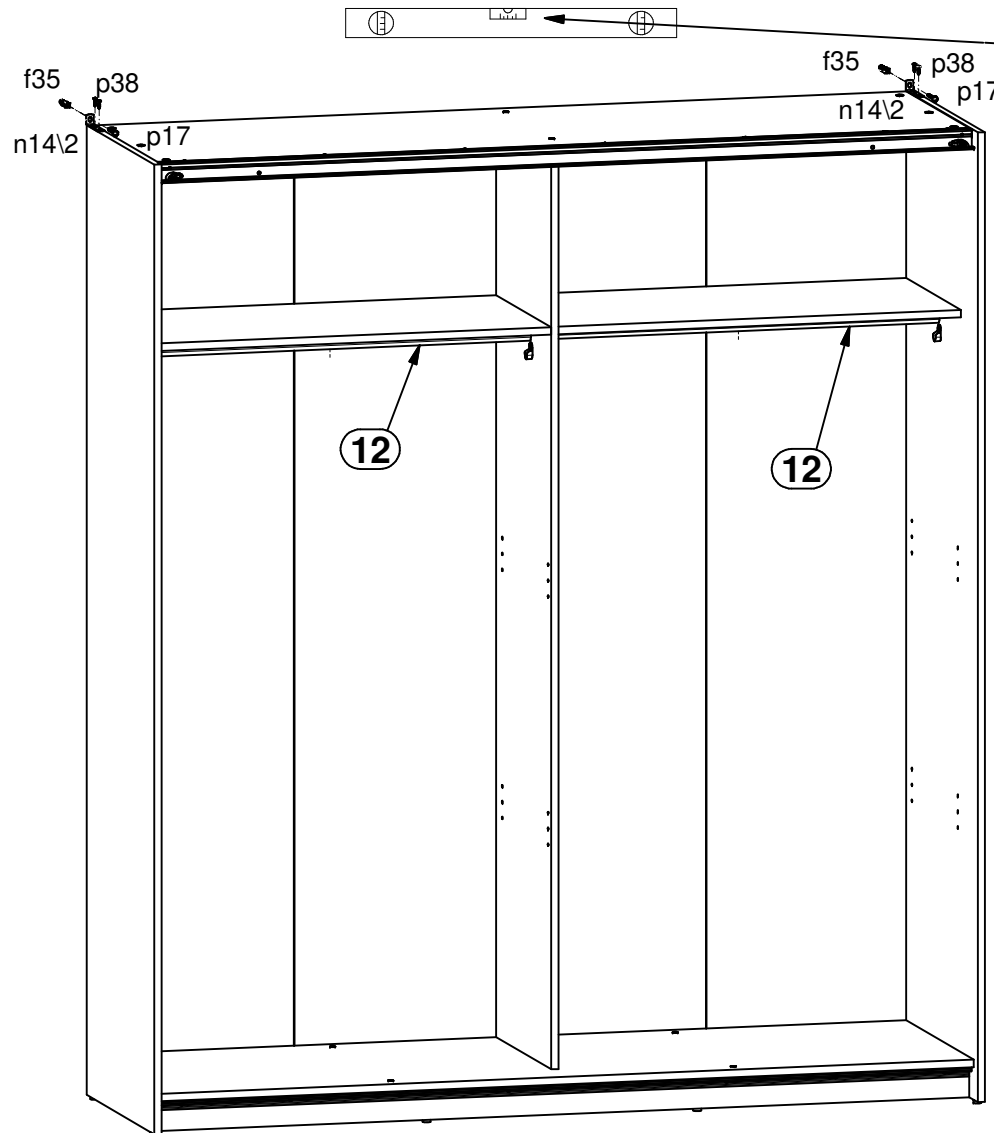

7

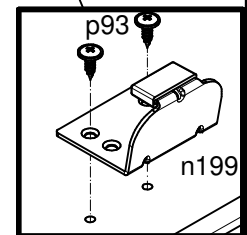
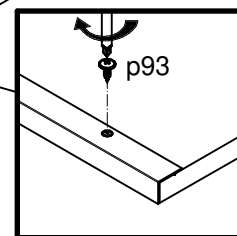
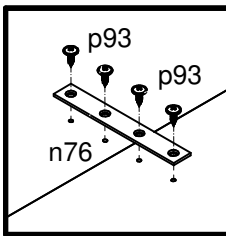
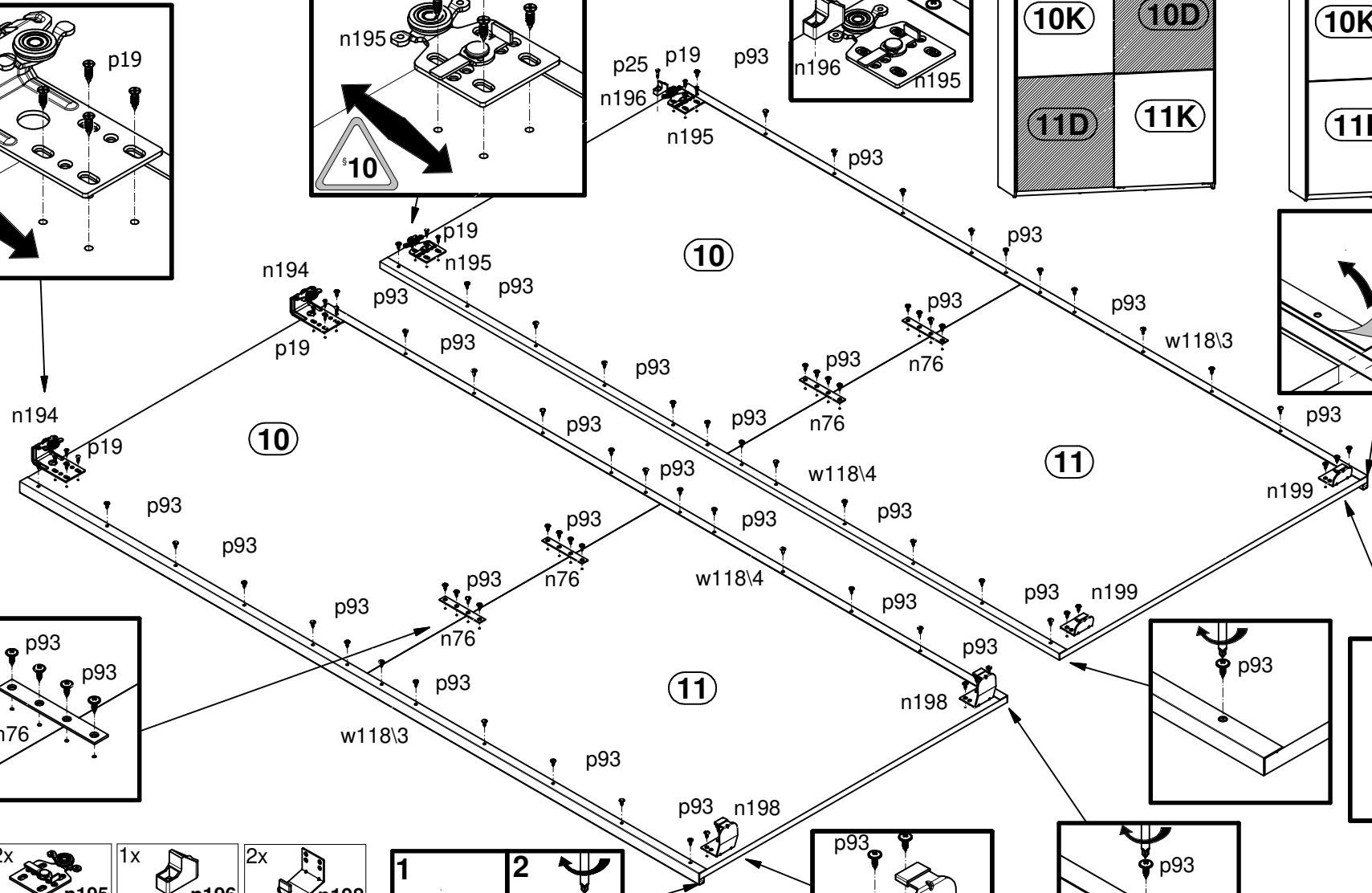
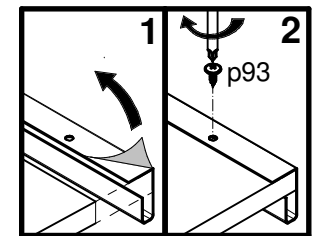
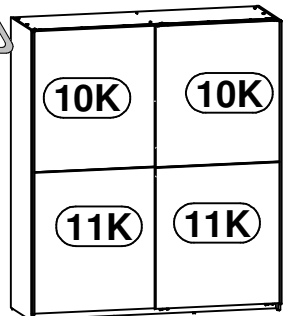
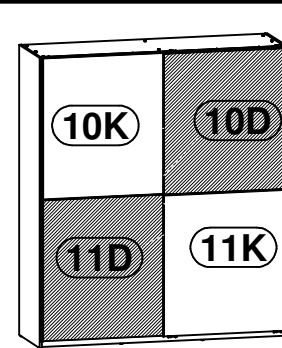
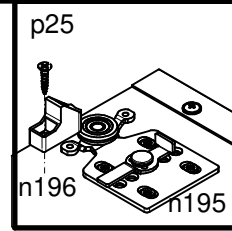
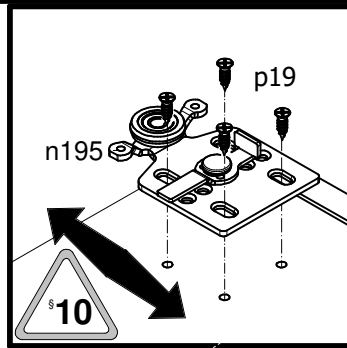
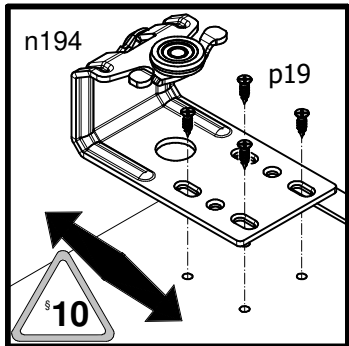

- | | | | |
|----------------------------|-------------------------------|-------------------------------|-----------------------------|
| 2x

n194 | 2x

n195 | 1x

n196 | 2x

n198 |
| 2x

n199 | 4x

n76 | 16x

p19
Ø4x16 mm | 1x

p25
Ø3.5x16 mm |
| 72x

p93
Ø4x13 mm | 2x

w118/3
L=1900 mm | 2x

w118/4
L=1900 mm | |

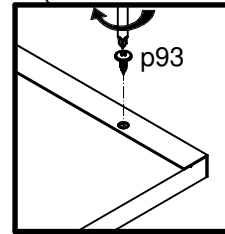
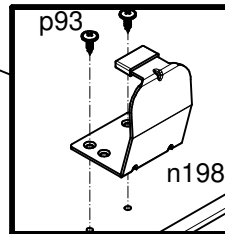
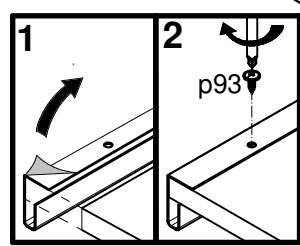

8

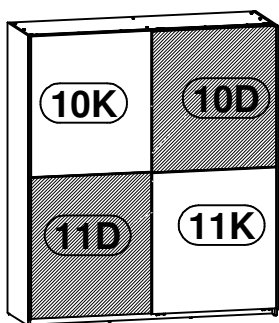

§14

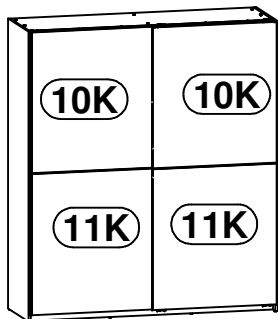

9

