

Roselle

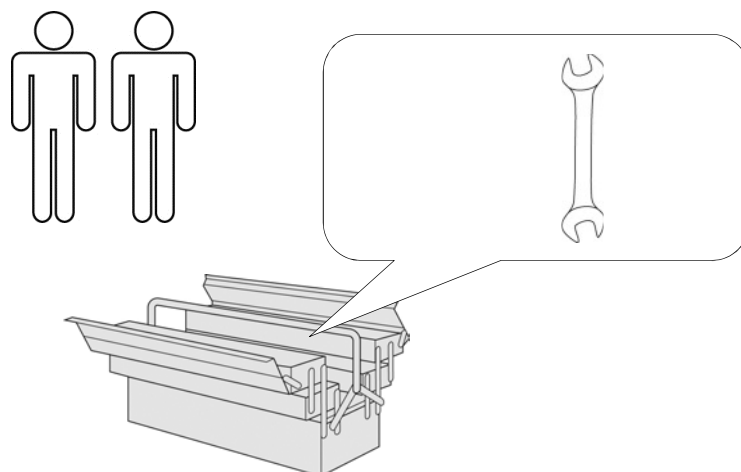

- | | |
|----------------------------------|---------------------------------------|
| D Montageanleitung | GB Assembly instructions |
| FR Notice de montage | NL Handleiding voor de montage |
| CZ Montážní návod | IT Istruzioni di montaggio |
| RO Instrucțiuni de montaj | RU инструкция по сборке |
| PL Instrukcja montażu | SK Návod na montáž |
| HU Szerelési útmutató | TR Montaj talimatı |





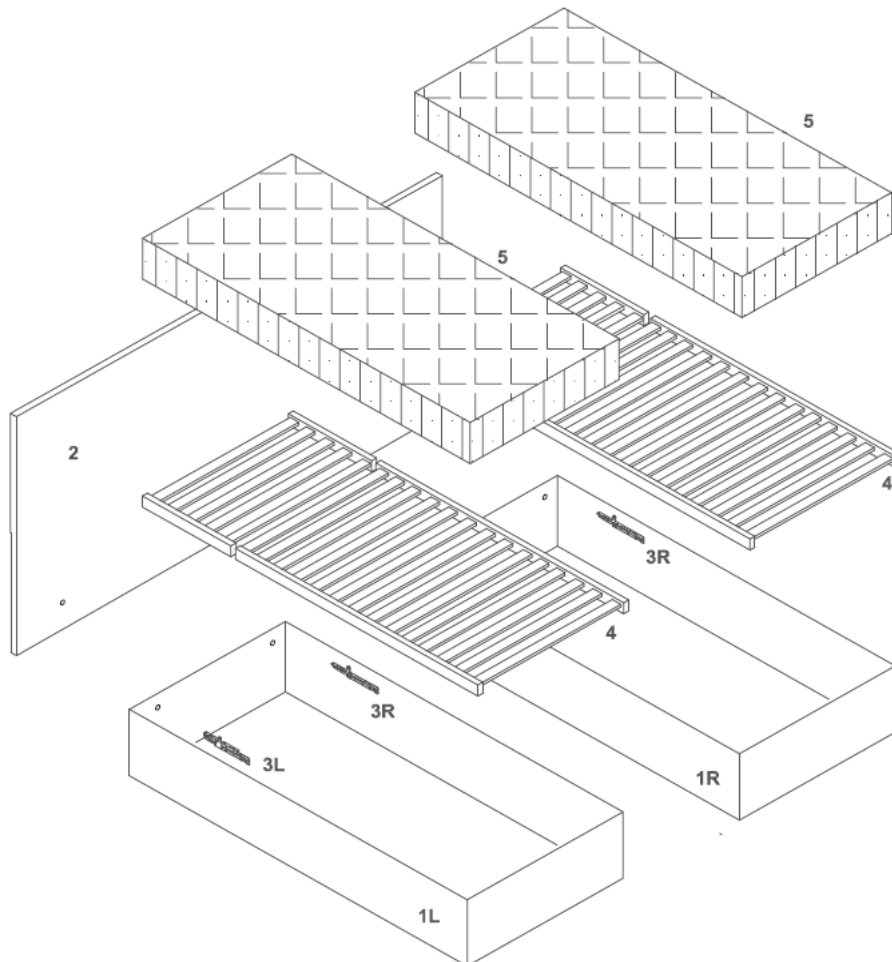

0
10
20
30
40
50
60
70
80
90
100
110
120
130
140
150
160
170
180
190
200

Service • Assistenza • Dienstverlening • Serwis Servis • Szerviz • Сервисная служба	
Name • Nom • Nome • Naam Nazwa • Jméno • Názov • Név Denúire • Ísim • Название	Roselle DB
Nr. • No. • N° • Номер • Č • Sz	SH55
Typ • Type • Tip • Típus • Тіро Тип	LARO

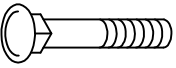

A	B	C	D	E	F	G	H
4x	1x 6x45	1x M6	1x M6	1x M6	4x 8x60	4x M8	4x M8



A		4x
B		1x 6x45
C		1x M6
D		1x M6
E		1x M6

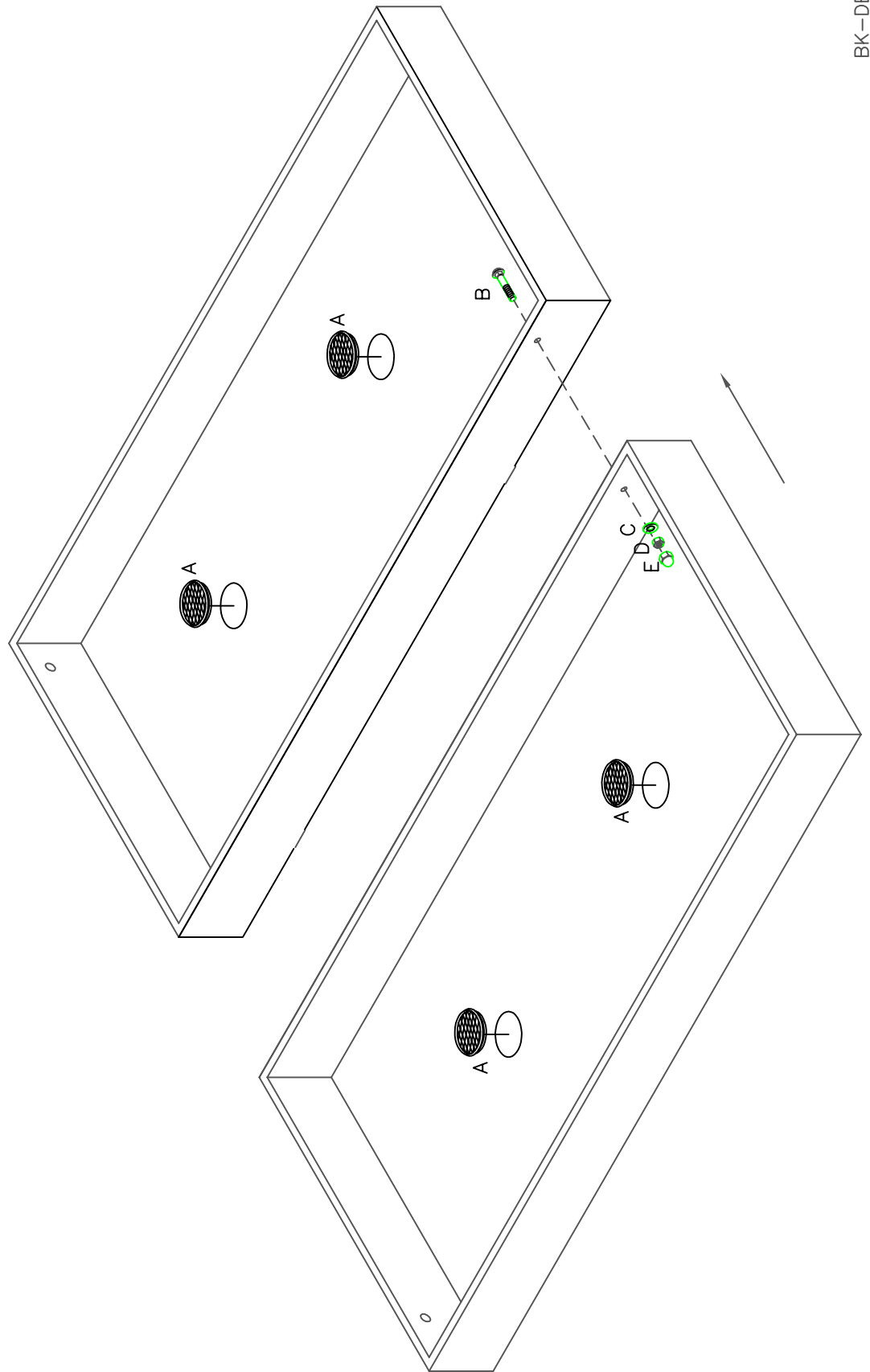

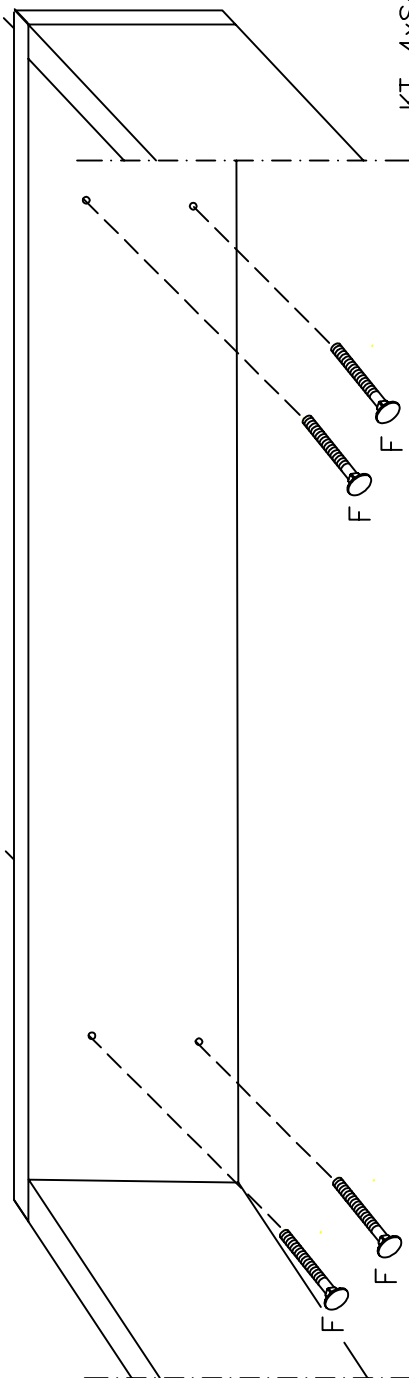
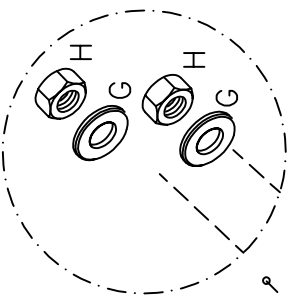
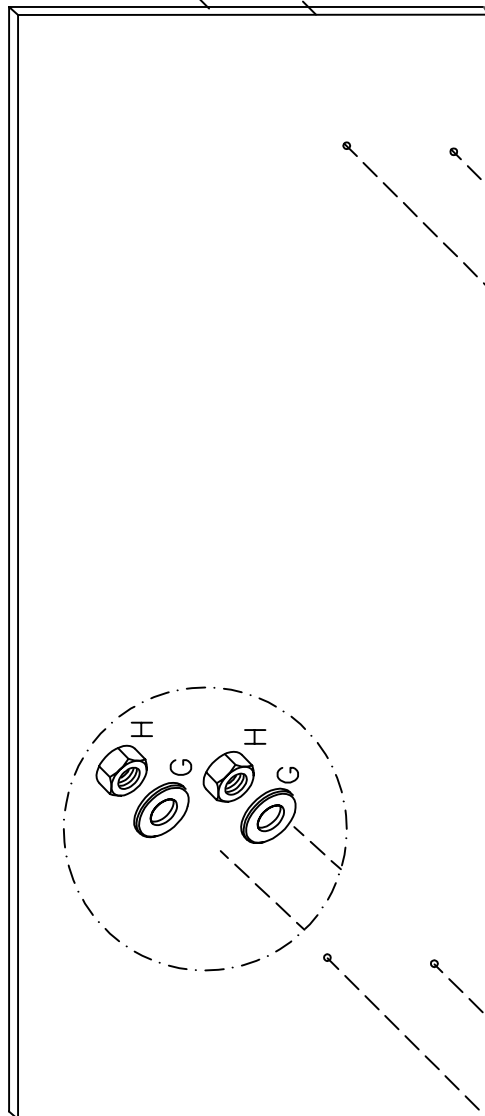
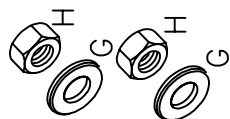

KT-4xSchloss-8x60

F		4x 8x60
G		4x M8
H		4x M8