

Louisville

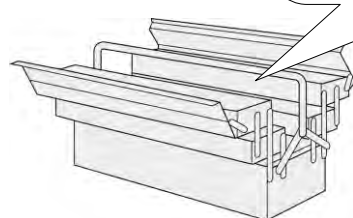

- | | |
|----------------------------------|---------------------------------------|
| D Montageanleitung | GB Assembly instructions |
| FR Notice de montage | NL Handleiding voor de montage |
| CZ Montážní návod | IT Istruzioni di montaggio |
| RO Instrucțiuni de montaj | RU инструкция по сборке |
| PL Instrukcja montażu | SK Návod na montáž |
| HU Szerelési útmutató | TR Montaj talimati |

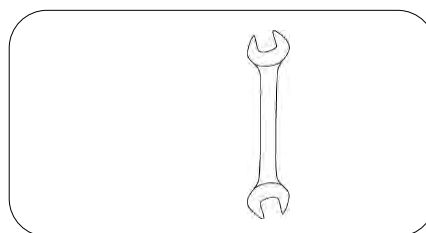
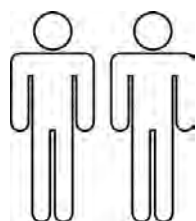

0
10
20
30
40
50
60
70
80
90
100
110
120
130
140
150
160
170
180
190
200

**Service • Assistenza • Dienstverlening • Serwis
Servis • Szerviz • Сервисная служба**

Name • Nom • Nome • Naam Nazwa • Jméno • Názov • Név Denumire • Ísim • Название	Louisville DB
Nr. • No. • N° • Номер • Č • Sz	SH55
Typ • Türe • Tip • Típus • Тіро Тип	OHNE

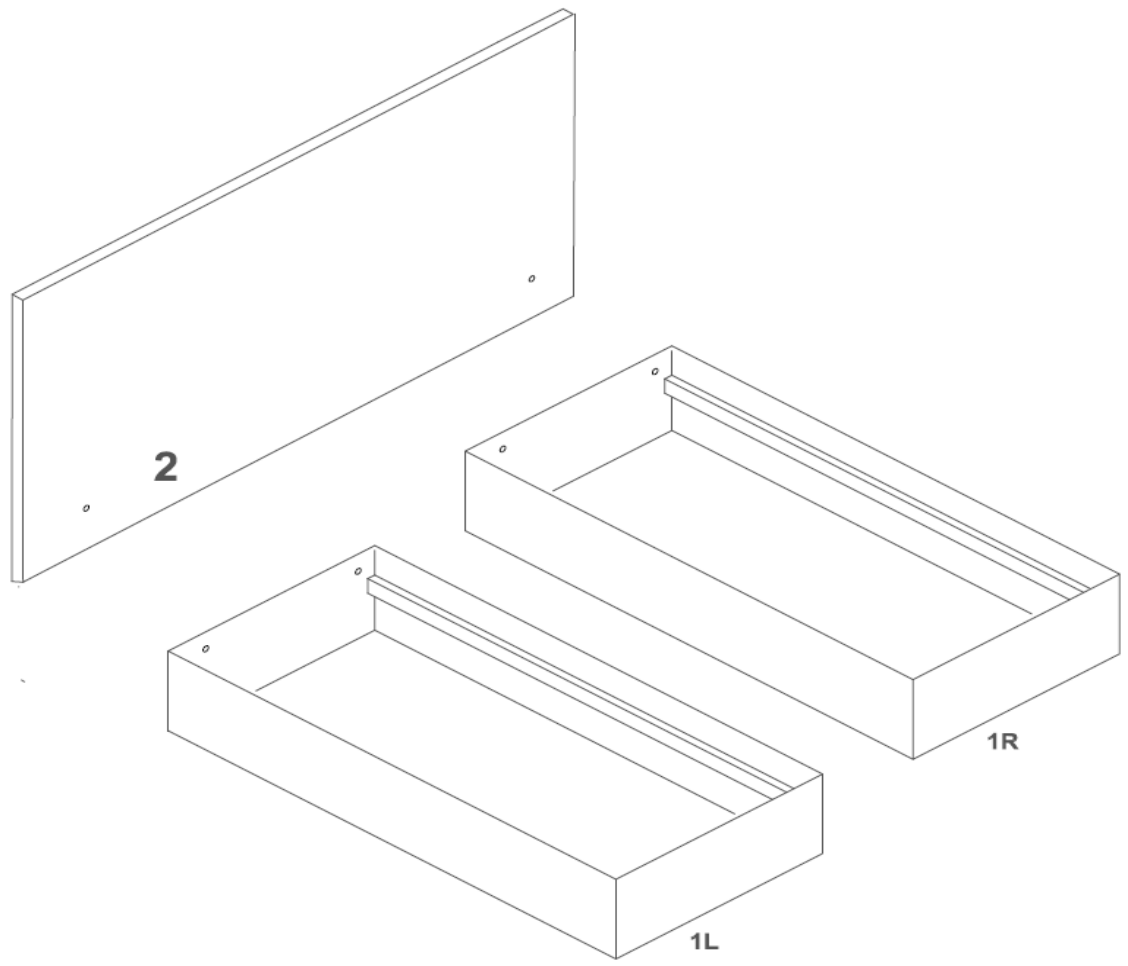
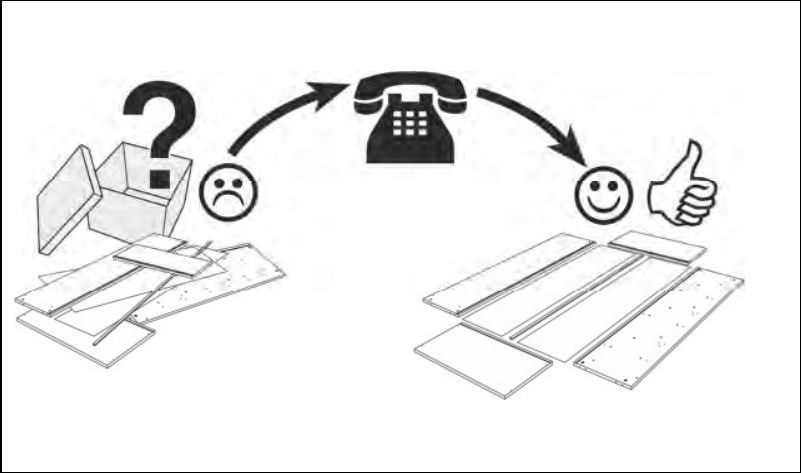
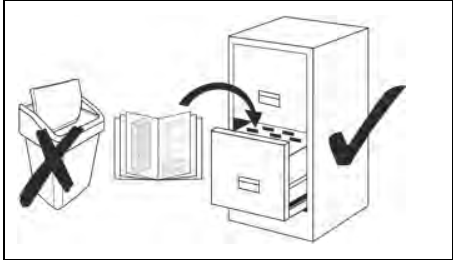

A	B	C	D	E	F	G	H
1x 6x45	1x 8x20	1x M6	1x M6	4x	4x 8x60	4x 8x40	4x M8

0
10
20
30
40
50
60
70
80
90
100
110
120
130
140
150
160
170
180
190
200



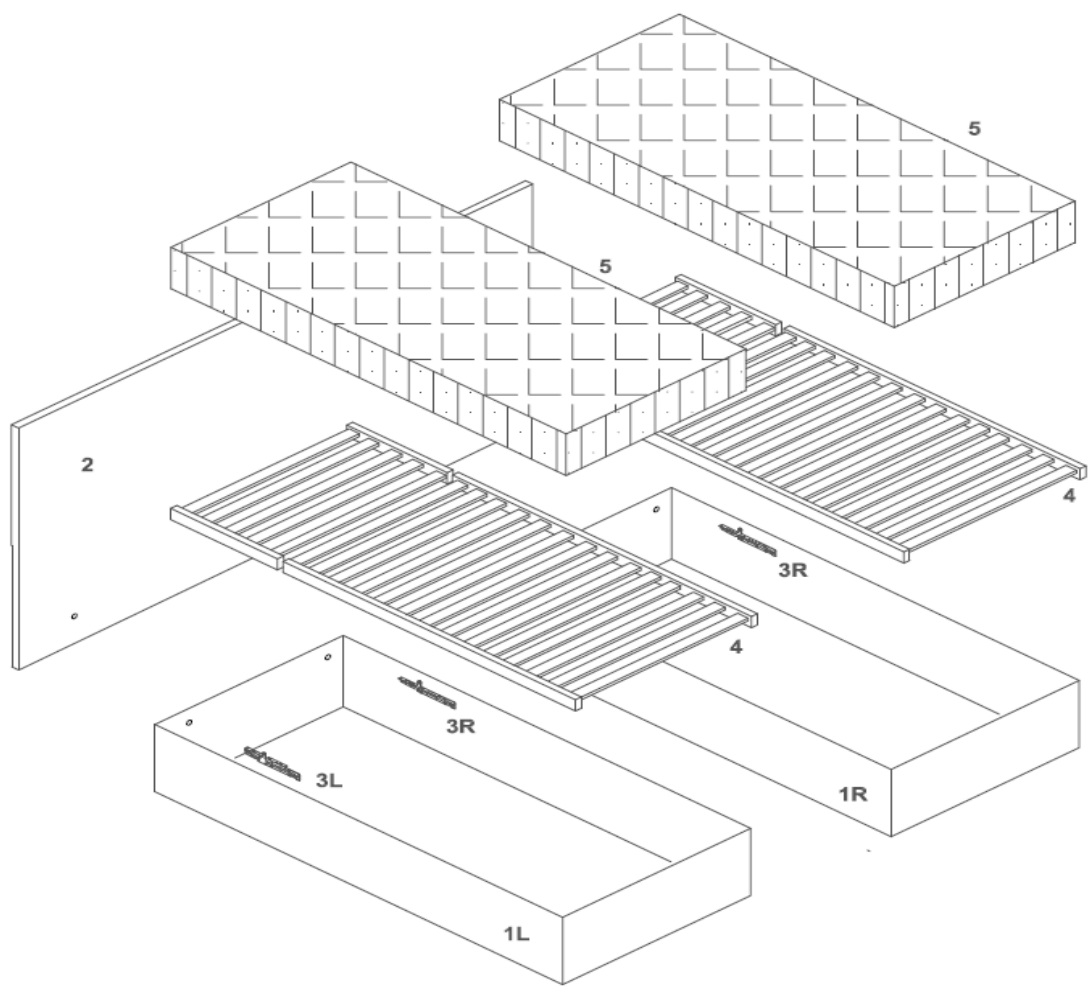
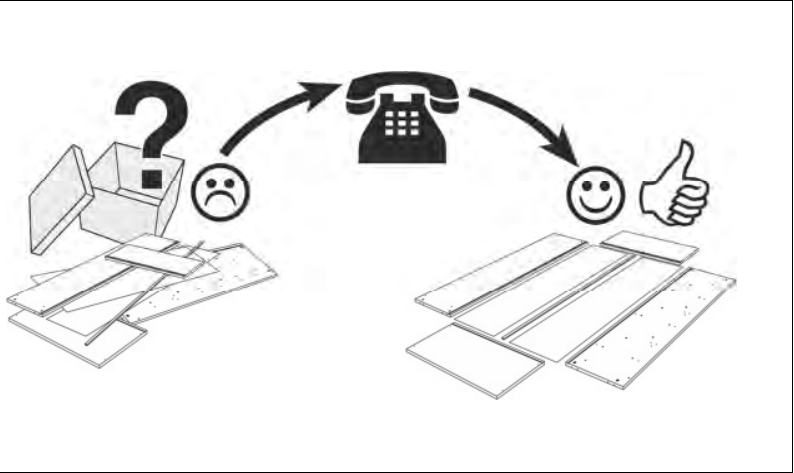
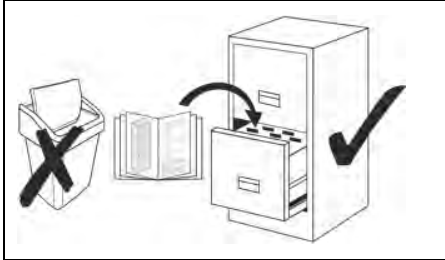

Service • Assistenza • Dienstverlening • Serwis Servis • Szerviz • Сервисная служба

Name • Nom • Nome • Naam Nazwa • Jméno • Názov • Név Denúire • Ísim • Название	Louisville DB
Nr. • No. • N° • Номер • Č • Sz	SH55
Typ • Type • Tip • Típus • Тіро Тип	LARO



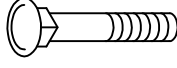

A	B	C	D	E	F	G	H
1x 6x45	1x 8x20	1x M6	1x M6	4x	4x 8x60	4x 8x40	4x M8

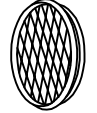
1

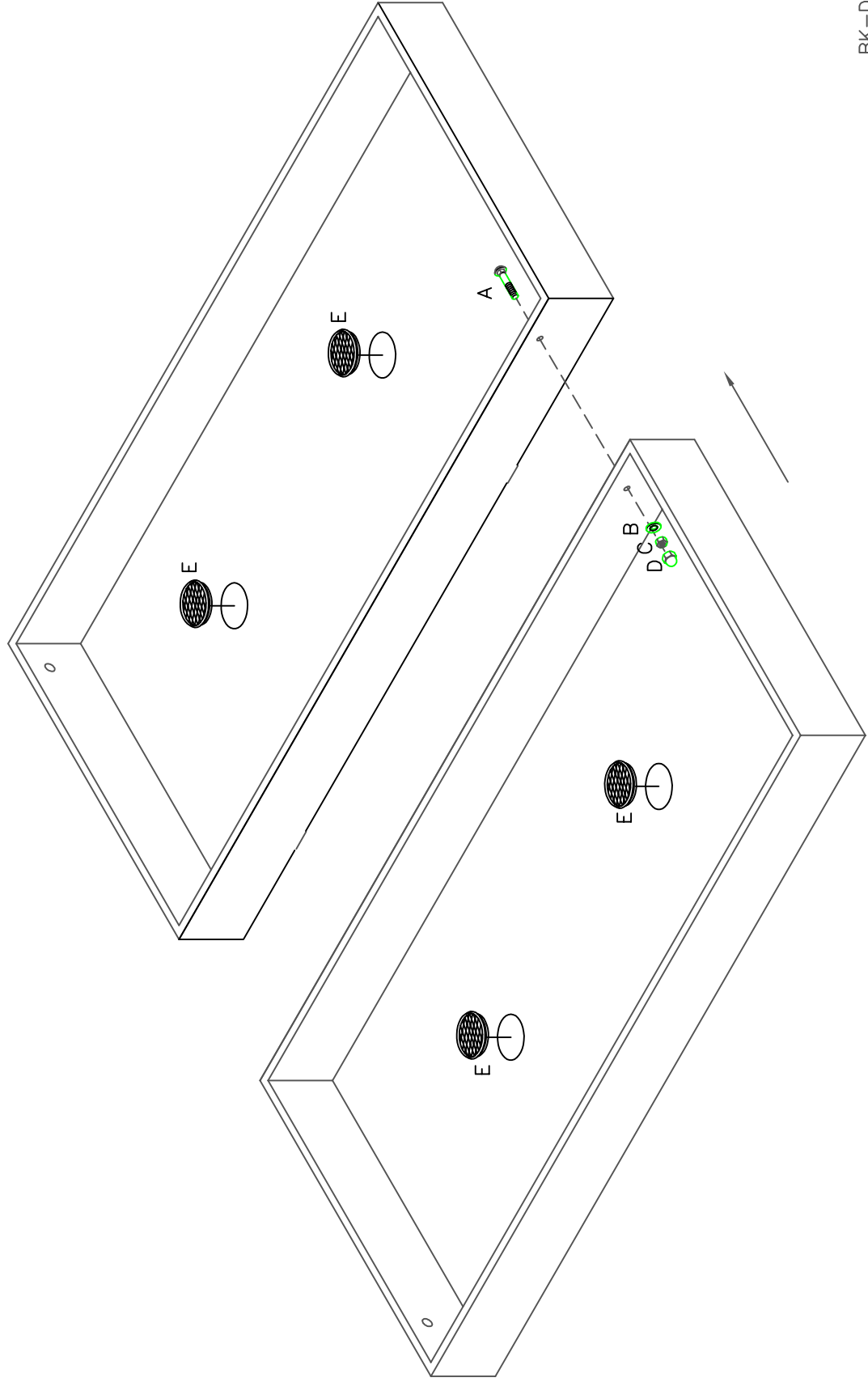
A	B	C	D	E
				
1 x 6x45	1 x 8x20	1 x M6	1 x M6	4 x



2.

F	G	H	Achtung! Schrauben nicht überdrehen	GB Watch Out! Do not over tighten
			FR Attention! Ne serrez pas trop	NL Let Op! Niet te vast
4x 8x60	4x 8x40	4x M8	CZ Dávej Pozor! Nepřetahujte	IT Attento! Non stringere
			RO Ai Grija! Nu strângeji	RU Осторожно! Не затягивайте
			PL Uwaga! Nie dokręcać zbyt mocno	SK Dávaj Pozor! Nepretahujte
			HU Vigyázz! Ne húzza túl	TR Dikkat! Üzerinde sıkmayın

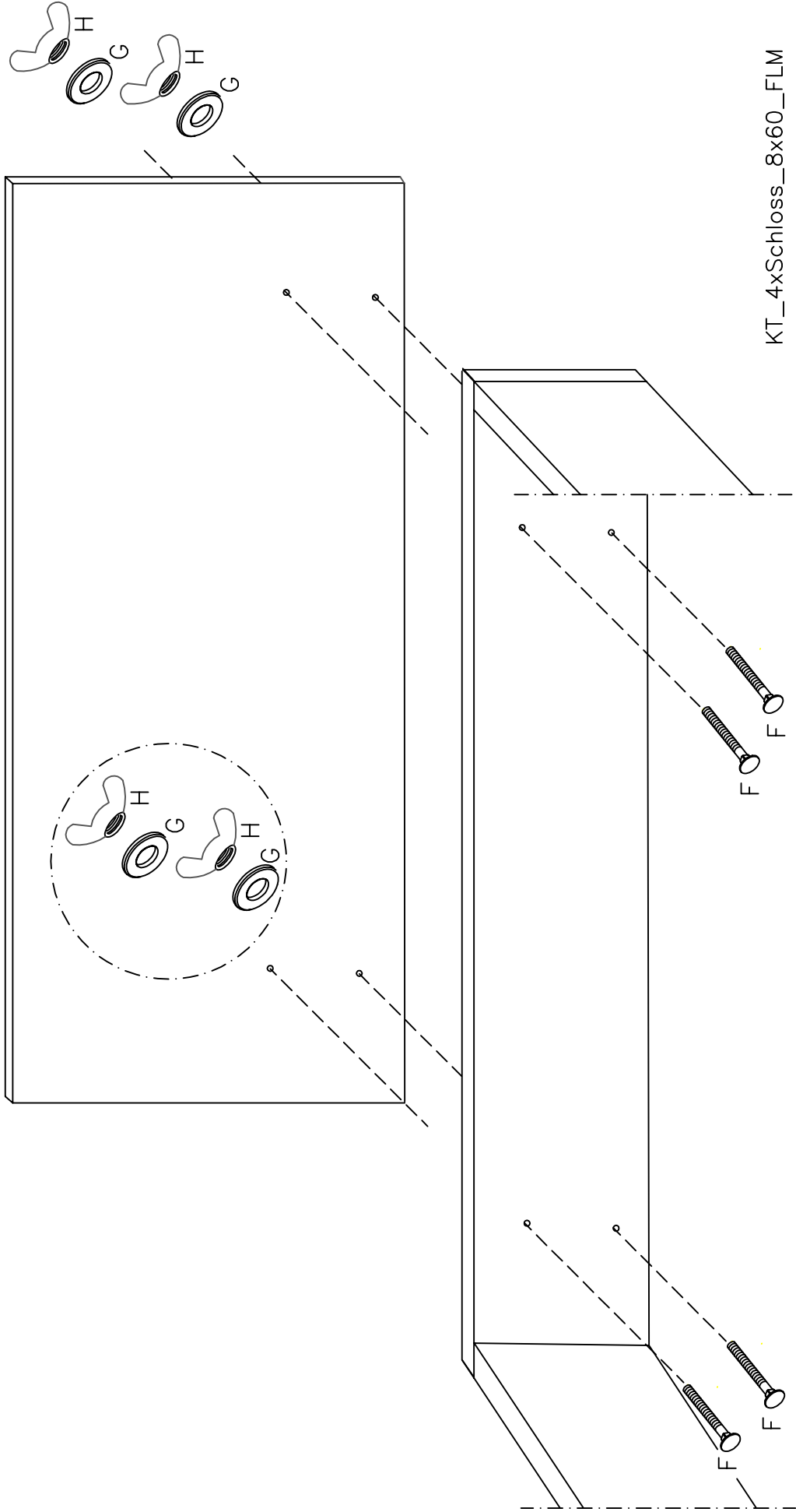

KT_4xSchloss_8x60_FLM