

Moulinex®

mega 2kg

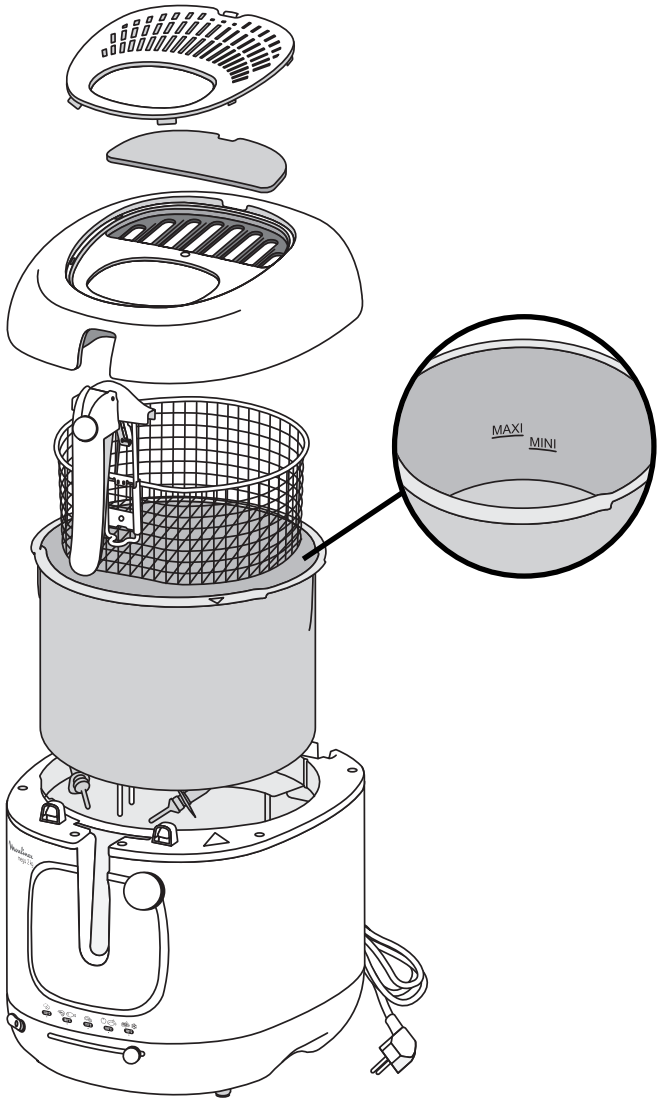

www.moulinex.com



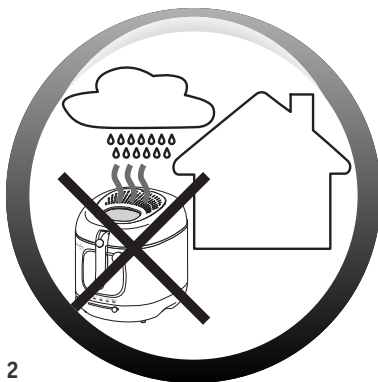
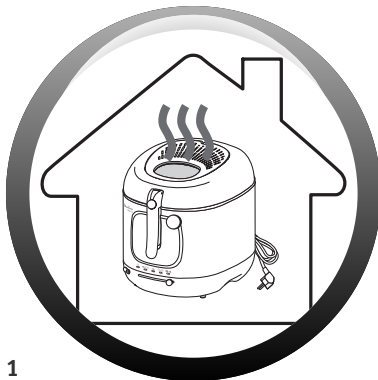

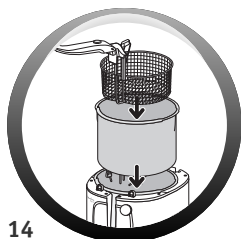
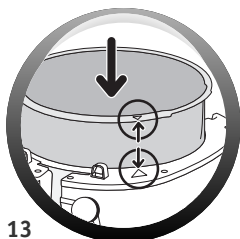
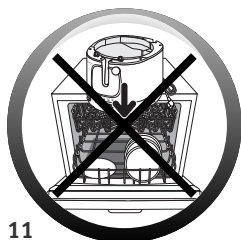
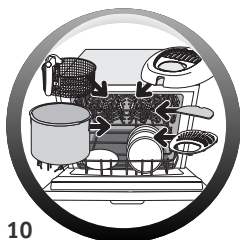
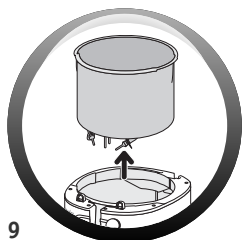
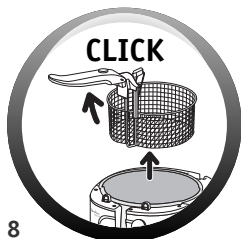
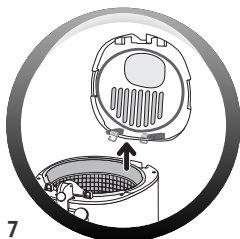
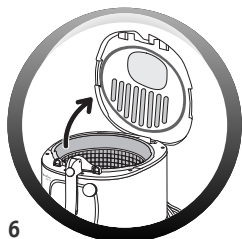
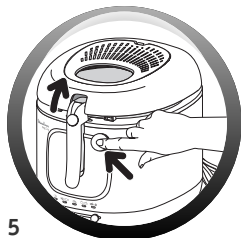
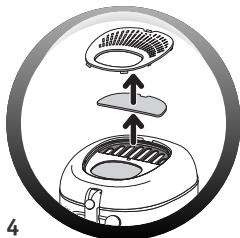
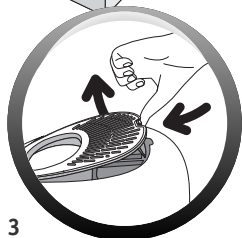

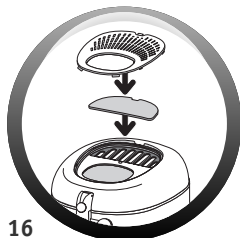
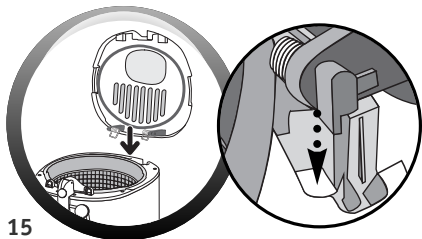

Mini = 3 L

Maxi = 3,3 L

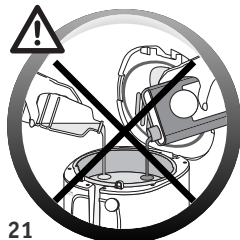
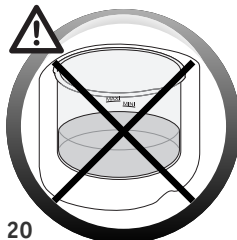
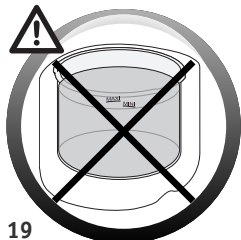
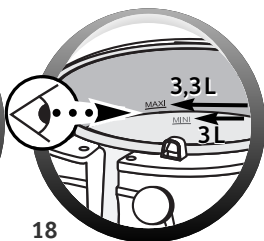
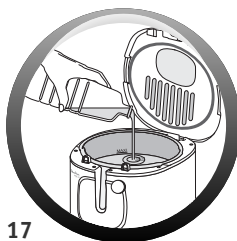

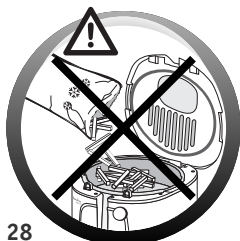
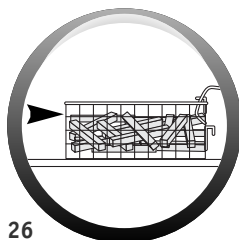
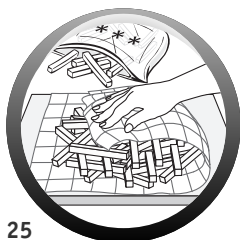
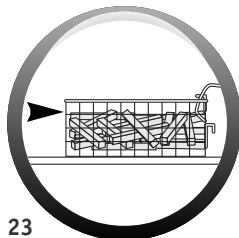
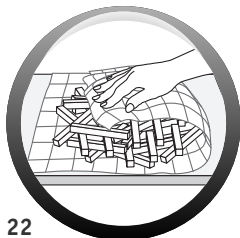
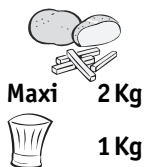
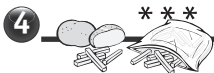

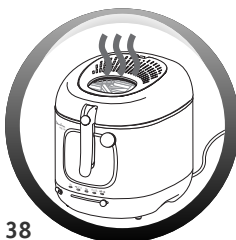
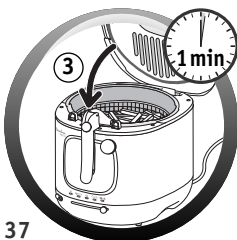
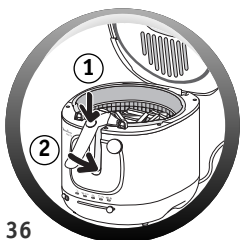
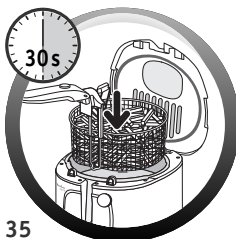
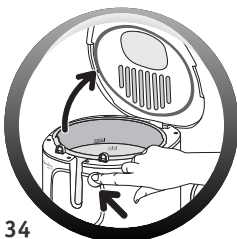
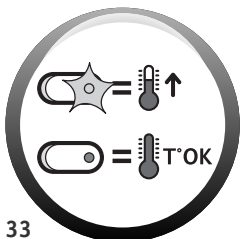
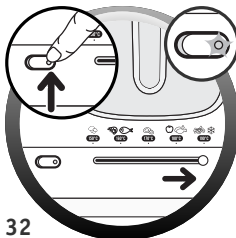
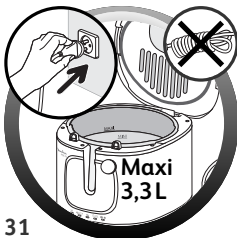
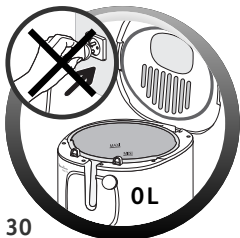



	Nb		°C	
		2 Kg	190°C	+/- 19-25 min
		2 Kg	1 - 160°C 2 - 190°C	+/- 14-17 min +/- 9-11 min
		1 Kg	190°C	+/- 11-15 min
		1 Kg	170°C	+/-12-16 min
	8-10		190°C	+/- 9-10 min
	3/4		180°C	+/-12-19 min
	1-2		160°C	+/- 4-7 min
		300 g	150°C	+/- 4-6 min
	10-12		180°C	+/-11-13 min
	6		180°C	+/- 5-6 min
* * *	Nb		°C	
		1,5 Kg	190°C	+/-13-19 min
		750 g	190°C	+/- 7-10 min
		750 g	170°C	+/- 8-11 min
		500 g	170°C	+/- 4-7 min
	10 p		190°C	+/- 5-7 min
		2 Kg	190°C	+/- 10-12 min
		300 g	190°C	+/- 3-5 min

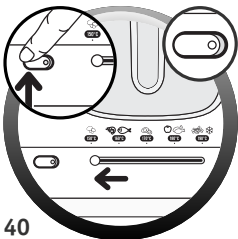

40

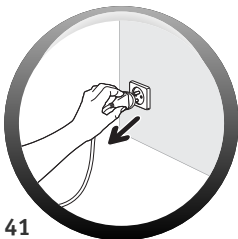

41

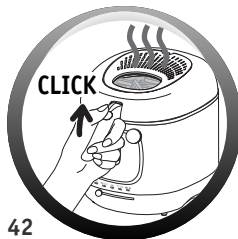

42

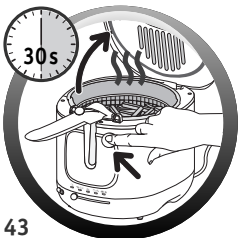

43

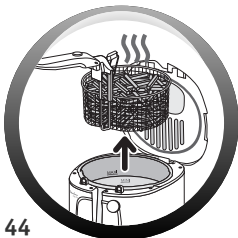

44

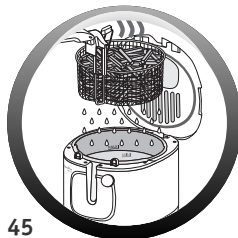

45



46

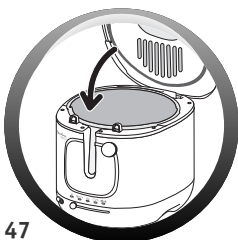

47

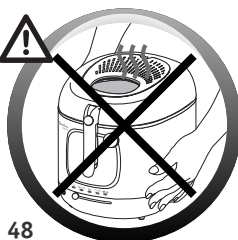

48

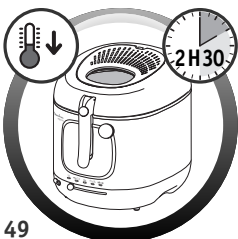

49

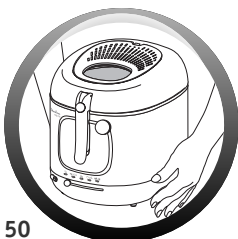

50

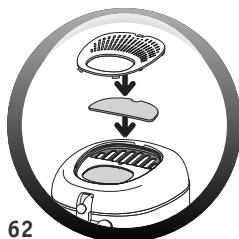
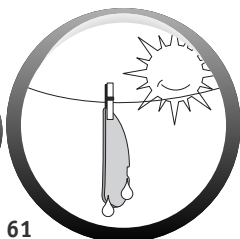
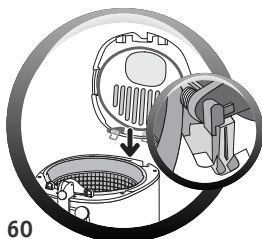
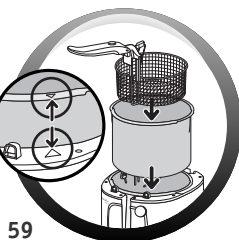
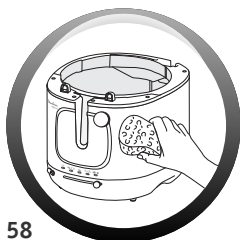
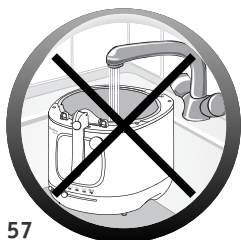
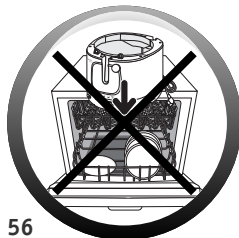
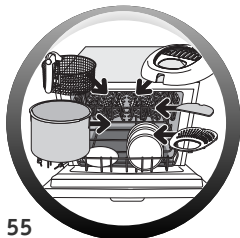
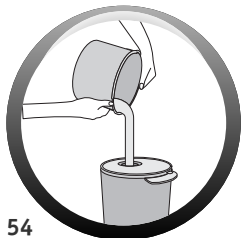
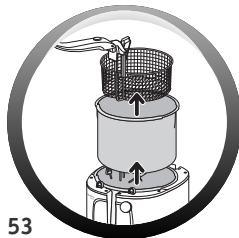
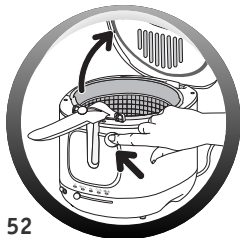
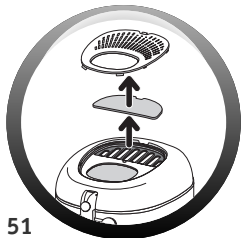

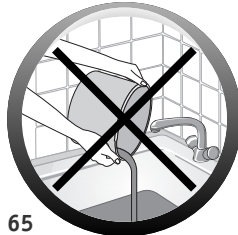
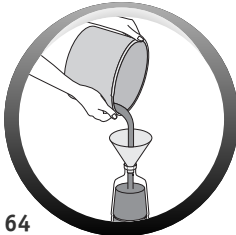
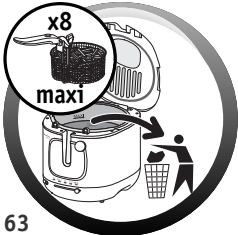

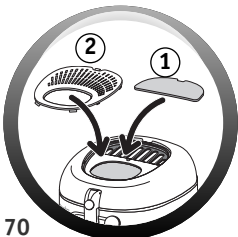
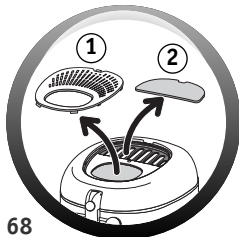

11 

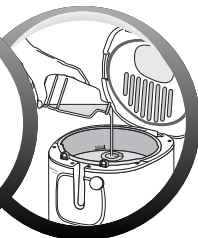
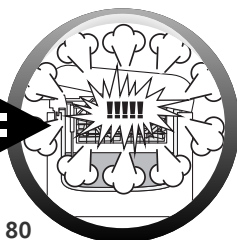
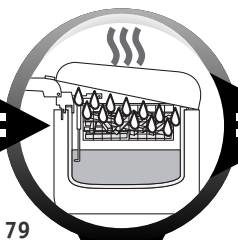
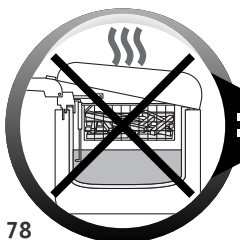
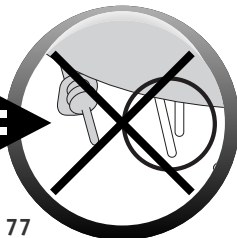
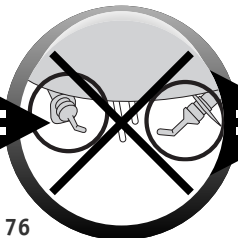
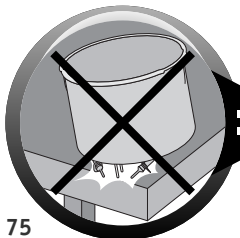
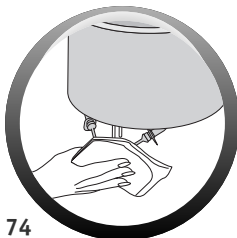

INTERNATIONAL GUARANTEE : COUNTRY LIST

			
الجزائر ALGERIA	(0)41- 28 18 53	سنة واحدة 1 year	CIA 9 rue Puvis de Chavannes - Saint Euquene Oran
ARGENTINA	0800-122-2732	2 años 2 years	GRUPE SEB ARGENTINA S.A Billinghurst 1833 3° - C1425DTK Capital Federal - Buenos Aires
ՀԱՅԱՍՏԱՆ ARMENIA	(010) 55-76-07	2 տարի 2 years	ՓԲԸ "Գրուպպա ՄԵԲ", 125171, Մոսկվա, Լենինգրադյան խմբակի, 16Ա, շին.3
AUSTRALIA	02 97487944	2 years	GRUPE SEB AUSTRALIA PO Box 7535, Silverwater - NSW 2128
ÖSTERREICH AUSTRIA		2 Jahre 2 years	SEB ÖSTERREICH GmbH Campus 21 - Businesspark Wien Süd, Liebermannstr. A02 702 - 2345 Brunn am Gebirge
БЕЛАРУСЬ BELARUS	017 2239290	2 года 2 years	ЗАО «Група СЕБ-Восток», 125171, Москва, Ленинградское шоссе, д. 16А, стр. 3
BELGIQUE-BELGIE BELGIUM	070 23 31 59	2 ans 2 years	GRUPE SEB BELGIUM SA NV 25 avenue de l'Espérance - ZI - 6220 Fleurus
BOSNA I HERCEGOVINA	Info-linija za potrošače 033 551 220	2 godine 2 years	SEB Développement Predstavništvo u BiH - Vrazova 8/II 71000 Sarajevo
BRASIL BRAZIL	0800-119933	1 ano 1 year	SEB COMERCIAL DE PRODUTOS DOMÉSTICOS LTDA Rua Venâncio Aires, 433/437/447, Pompéia, São Paulo/SP
БЪЛГАРИЯ BULGARIA	0700 10 330	2 години 2 years	ГРУП СЕБ БЪЛГАРИЯ ЕООД бул. България 81 В, ет. 5 - 1404 София
CANADA	1-800-418-3325	1 an 1 year	GRUPE SEB CANADA 345 Passmore Avenue Toronto, ON - M1V 3N8
CHILE	12300 209207	2 años 2 years	GRUPE SEB CHILE Comercial Ltda Av. Providencia, 2331, piso 5, Oficina 501 - Santiago
COLOMBIA	18000919288	2 años 2 years	GRUPE SEB COLOMBIA Apartado Aereo 172, Kilometro 1 Via Zipaquirá - Cajica Cundinamarca
HRVATSKA CROATIA	01 30 15 294	2 godine 2 years	SEB Développement S.A.S. Vodnjanska 26, 10000 Zagreb
ČESKÁ REPUBLIK CZECH REPUBLIC	731 010 111	2 roky 2 years	GRUPE SEB ČR spol. s r. o. Jankovcova 1569/2c - 170 00 Praha 7
DANMARK DENMARK	44 663 155	2 år 2 years	GRUPE SEB NORDIC AS Tempovej 27 - 2750 Ballerup
EESTI ESTONIA	5 800 3777	2 aastat 2 years	GRUPE SEB POLSKA SP. z o.o. ul. Bukowińska 22b - 02-703 Warszawa
مصر EGYPT	الخط الساخن : 16622	سنة واحدة 1 year	جروب سب ايجيبت طريق 14 مايو - سموحة الإسكندرية - مصر
SUOMI FINLAND	09 622 94 20	2 Vuotta 2 years	Group SEB Finland Kutojantie 7 - 02630 Espoo
FRANCE Continentale + Guadeloupe, Martinique, Réunion, Saint-Martin	09 74 50 10 14	1 an 1 year	GRUPE SEB FRANCE Service Consommateur Moulinex BP 15 - 69131 ECULLY CEDEX

			
DEUTSCHLAND GERMANY	0212 387 400	2 Jahre 2 years	GRUPE SEB DEUTSCHLAND GmbH KRUPS GmbH Herrnrainweg 5 - 63067 Offenbach
ΕΛΛΑΔΑ GREECE	2106371251	2 χρόνια 2 years	SEB GROUPE ΕΛΛΑΔΟΣ Α.Ε. Οδός Καβαλιεράτου 7 Τ.Κ. 145 64 Ν. Κηφισιά
香港 HONG KONG	8130 8998	1 year	SEB ASIA Ltd. Room 903, 9/F, South Block, Skyway House 3 Sham Mong Road, Tai Kok Tsui, Kowloon - Hong-Kong
MAGYARORSZÁG HUNGARY	06 1 801 8434	2 év 2 years	GRUPE SEB CENTRAL-EUROPE Kft. Táviró köz 4 - 2040 Budaörs
INDONESIA	+62 21 5793 6881	1 year	Groupe SEB Indonesia (Representative office) Sudirman Plaza, Plaza Marein 8th Floor JL Jendral Sudirman Kav 76-78, Jakarta 12910, Indonesia
ITALIA ITALY	1 99 207 892	2 anni 2 years	GRUPE SEB ITALIA S.p.A. Via Montefeltro, 4 - 20156 Milano
日本 JAPAN	0570 077 772	1 year	株式会社グループセブジャパン - 〒141-0022 東京都品川区東五反田3-14-13 - 高輪ミュージアムビル
ҚАЗАҚСТАН KAZAKHSTAN	727 378 39 39	2 жыл 2 years	ЖАҚ «Группа СЕБ- Восток» 125171, Москва, Ленинградское шоссе, 16А, 3 үйі
한국어 KOREA	1588-1588	1 year	(유)그림 세브 코리아 서울시 종로구 서린동 88 서린빌딩 - 3층, 110-790
LATVJA LATVIA	6 716 2007	2 gadi 2 years	GRUPE SEB POLSKA Sp. z o.o. ul. Bukowińska 22b 02-703 Warszawa
LIETUVA LITHUANIA	6 470 8888	2 years	GRUPE SEB POLSKA Sp. z o.o. ul. Bukowińska 22b 02-703 Warszawa
LUXEMBOURG	0032 70 23 31 59	2 ans 2 years	GRUPE SEB BELGIUM SA NV 25 avenue de l'Espérance - ZI - 6220 Fleurus
МАКЕДОНИЈА MACEDONIA	(0)2 2050 022	2 години 2years	Groupe SEB Bulgaria FOOD Office 1, floor 1, 52G Borovo St., 1680 Sofia - Bulgaria ГРУП СЕБ БЪЛГАРИЯ ДООЕЛ Ул. Борово 52 Г, сп. 1, офис 1, 1680 София - България
MALAYSIA	603 7710 1175	1 year	GRUPE SEB MALAYSIA SDN. BHD Unit No. 402-403, Level 4, Uptown 2, No. 2, Jalan SS21/37, Damansara Uptown, 47400, Petaling Jaya, Selangor D.E Malaysia
MEXICO	(01800) 112 8325	1 año 1 year	Groupe.S.E.B. México, S.A. DE C.V. Goldsmith 38 Desp. 401, Col. Polanco Delegación Miguel Hidalgo - 11 560 México D.F.
MOLDOVA	(22) 929249	2 ani 2 years	ТОВ «Груп СЕБ Україна» 02121, Харківське шосе, 201-203, 3 поверх, Київ, Україна
NEDERLAND The Netherlands	0318 58 24 24	2 jaar 2 years	GRUPE SEB NEDERLAND BV De Schutterij 27 - 3905 PK Veenendaal - Nederland
NEW ZEALAND	0800 700 711	1 year	GRUPE SEB NEW ZEALAND Unit E, Building 3, 195 Main Highway, Ellerslie, Auckland
NORGE NORWAY	815 09 567	2 år 2 years	GRUPE SEB NORDIC AS Tempovej 27 - 2750 Ballerup
PERU	441 4455	1 año 1 year	Groupe SEB Perú Av. Camino Real N° 111 of. 805 B - San Isidro - Lima

			
POLSKA POLAND	0801 300 423 koszt jak za połączenie lokalne	2 lata 2 years	GRUPE SEB POLSKA Sp. z o.o ul. Bukowińska 22b 02-703 Warszawa
PORTUGAL	808 284 735	2 anos 2 years	GRUPE SEB IBÉRICA SA Urb. da Matinha - Rua Projectada à Rua 3 Bloco 1 - 3° B/D 1950 - 327 Lisboa
REPUBLIC OF IRELAND	01 677 4003	1 year	GRUPE SEB IRELAND Unit B3 Aerodrome Business Park, College Road, Rathcoole, Co. Dublin
ROMANIA ROMANIA	0 21 316 87 84	2 ani 2 years	GRUPE SEB ROMÂNIA Str. Daniel Constantin nr. 8 - 010632 Bucuresti
РОССИЯ RUSSIA	495 213 32 29	2 года 2 years	ЗАО «Группа СЕБ-Восток», 125171, Москва, Ленинградское шоссе, д. 16А, стр. 3
SRBIJA SERBIA	060 0 732 000	2 godine 2 years	SEB Development Đorđa Stanojevića 11b 11070 Novi Beograd
SINGAPORE	6550 8900	1 year	GRUPE SEB SINGAPORE Pty Ltd. 59 Jalan Pernipin, #04-01/02 L&Y Building Singapore 577218
SLOVENSKO SLOVAKIA	233 595 224	2 roky 2 years	GRUPE SEB SLOVENSKO spol. s.r.o. Rybničná 40 - 831 06 Bratislava
SLOVENIJA SLOVENIA	02 234 94 90	2 leti 2 years	SEB d.o.o Gregorčičeva ulica 6 - 2000 MARIBOR
ESPAÑA SPAIN	902 31 22 00	2 años 2 years	GRUPE SEB IBÉRICA S.A. C/ Almogàvers, 119-123, Complejo Ecurban 08018 Barcelona
SVERIGE SWEDEN	08 594 213 30	2 år 2 years	TEFAL SVERIGE SUBSIDIARY OF GROUP SEB NORDIC Truckvägen 14 A, 194 52 Upplands - Väsby
SUISSE / SCHWEIZ SWITZERLAND	044 837 18 40	2 ans 2 Jahre 2 years	GRUPE SEB SCHWEIZ GmbH Thurgauerstrasse 105 8152 Glattbrugg
台灣 TAIWAN	02 28333716	1 year	SEB ASIA Ltd. Taiwan Branch 4F., No. 37 Dexing W. Rd., Shilin Dist., Taipei City 11158, Taiwan (R.O.C.)
ประเทศไทย THAILAND	02 769 7477	2 years	GRUPE SEB THAILAND 2034/66 Italthai Tower, 14th Floor, n° 14-02, New Phetchaburi Road, Bangkapi, Huaykwang, Bangkok, 10320
TÜRKIYE TURKEY	216 444 40 50	2 YIL 2 years	GRUPE SEB ISTANBUL AS Beybi Giz Plaza Dereboyu Cad. - Meydan Sok. No: 28 K.12 Maslak
U.S.A.	800-395-8325	1 year	GRUPE SEB USA 2121 Eden Road - Millville, NJ 08332
УКРАЇНА UKRAINE	044 300 13 04		ТОВ «Група СЕБ Україна» 02121, Харківське шосе, 201-203, 3 поверх, Київ, Україна
UNITED KINGDOM	0845 602 1454	1 year	GRUPE SEB UK LTD Riverside House, Riverside Walk Windsor, Berkshire, SL4 1NA
VENEZUELA	0800-7268724	2 años 2 year	GRUPE SEB VENEZUELA Av Eugenio Mendoza, Centro Letonia, Torre ING Bank, Piso 15, Ofc 155 - Urb. La Castellana, Caracas
VIETNAM	08 38645830	1 year	Vietnam Fan Joint Stock Company 25 Nguyen Thi Nhu Str, Ward 9, Tan Binh Dist, HCM city

 www.moulinex.com

MOULINEX INTERNATIONAL GUARANTEE

Date of purchase: / Date d'achat / Fecha de compra / Data da compra / Data d'acquisto / Kaufdatum / Aankoopdatum / Købsdato / Inköpsdatum / Kjøpsdato / Ostopäivä / Data zakupu / Data vânzării / [sigijimo data/ Ostukuupäev / Datum nakupa / Sorozatszám / Dátum nákupe / Pirkuma datums / Datum Kupovine / Datum kupnje / Data cumpărării / Datum nákupe / Tarikh pembelian / Tanggal pembelian / Ngay mua hàng/ Satin alma tarihi / Дата прџдажи / Дата на закупуване / Датум на купување / Сатылган мерзімі / Ημερομηνία αγοράς / Ἡμερομηνία ἀγορᾶς / วันที่ซื้อ / 購買日期 / 購入日 / 구입일자 / تاريخ الشراء / خرید تاريخ

Product reference: / Référence du produit / Referencia del producto / Referência do produto / tipo de produto / Typnummer des Gerätes / Artikelnummer van het apparaat / Referencenummer / Produktreferens / Artikelnummer / Tuotenumero / referenja produktu / Model / Gaminio numeris / Toote viitenumber / Tip aparata / Vásárlás kelte / Typ výrobku / Produkta atsauce numurs / Model proizvoda / Oznaka proizvoda / Cod produs / Produkt rujukan / Referensi produk / Mã sản phẩm/ Ürün kodu / Модель / Модель / Модел на уреда / Модели / Κωδικός προϊόντος / Μητρώο / รุ่นผลิตภัณฑ์ / 產品模型 / 製品レファレンス番号/제품명 / مرجع المنتج الكامل / مرجع كامل محصول

Retailer name & address: / Nom et adresse du vendeur / Nombre y dirección del minorista / Nome e endereço do revendedor / Nome e indirizzo delnegozio / Name und Anschrift des Händlers / Naam en adres van de dealer / Forhandler navn & adresse / Återförsäljarens namn och adress / Forhandler navn og adresse / Jälleenmyyjän nimi ja osoite / nazwa i adres sprzedawcy / Numele și adresa vânzătorului / Parduotuvės pavadinimas ir adresas / Müüja kauplus ja aadress / Naziv in naslov trgovine / Tipusszám / Názov a adresa predajcu / Veikala nosaukums un adrese / Naziv i adresa malprodaje / Naziv i adresa prodavca / Naziv i adresa prodajnog mjesta / Nume și adresă vânzător / Název a adresa prodejce / Nama dan alamat peruncit / Nama Toko Penjual dan alamat / Tên và địa chỉ cửa hàng bán/ Satici firmanin adı ve adresi / Название и адрес прџдавца / Назва i adresa прџдавца / Търговски пбект / Назив и адреса на прџдавницата / Сатушының аты және мекен-жайы / Επωνυμία και διεύθυνση καταστήματος / Ἡμερομηνία ἀγορᾶς / 零售商的店名和地址/販売店の名前、住所/소매점 이름과 주소 / نام و آدرس خرده فروش / اسم وعنوان بائع التجزئة

Distributor stamp Cachet distributeur / Sello del distribuidor / Carimbo do revendedor / Timbro del negozio / Händlerstempel / Stempel van de dealer / Forhandler stempel / Återförsäljarens stämpel / Forhandler stempel / Jälleenmyyjän leima / pieczęć sprzedawcy / Ştampila vânzătorului / Antspaudas / Tempel / Žig trgovine / Eladó neve, címe/ Razítko predajcu / Zimogs / Pečat malprodaje/ Pečat prodavca / Pečat prodajnog mjesta / Ştampila vânzătorului/ Razítko prodejce/ Cap peruncit / Cap dari Toko Penjual / Cửa hàng bán đóng dấu/ Satici Firmanin Kaşesi / Печать прџдавца / Печатка прџдавца / Печат на търговския пбект / Печат на прџдавницата / Сатушының мөрі / Σφραγίδα καταστήματος / Ἡμερομηνία ἀγορᾶς / 零售商的蓋印 / 販売店印 / 소매점 직인 / فروش مهر خرده / ختم بائع التجزئة

Moulinex®

mega 2kg