

## Lago 2 A

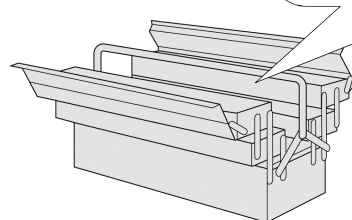

- |                                  |                                       |
|----------------------------------|---------------------------------------|
| <b>D</b> Montageanleitung        | <b>GB</b> Assembly instructions       |
| <b>FR</b> Notice de montage      | <b>NL</b> Handleiding voor de montage |
| <b>CZ</b> Montážní návod         | <b>IT</b> Istruzioni di montaggio     |
| <b>RO</b> Instrucțiuni de montaj | <b>RU</b> инструкция по сборке        |
| <b>PL</b> Instrukcja montażu     | <b>SK</b> Návod na montáž             |
| <b>HU</b> Szerelési útmutató     | <b>TR</b> Montaj talimati             |

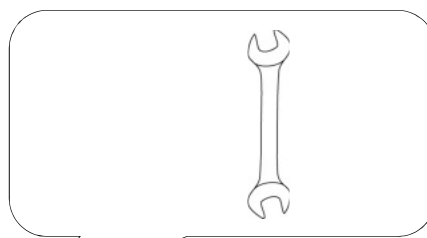
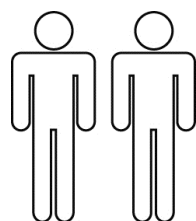
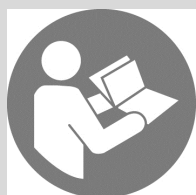

0  
10  
20  
30  
40  
50  
60  
70  
80  
90  
100  
110  
120  
130  
140  
150  
160  
170  
180  
190  
200

<b>Service • Assistenza • Dienstverlening • Serwis</b> <b>Servis • Szerviz • Сервисная служба</b>		
Name • Nom • Nome • Naam Nazwa • Jméno • Názov • Név Denumire • İsim • Название	<b>Lago 2 A DB</b>	
Nr. • No. • N° • Номер • Č • Sz	<b>SH42</b>	
Typ • Type • Tip • Típus • Tipo Тип	<b>OHNE</b>	

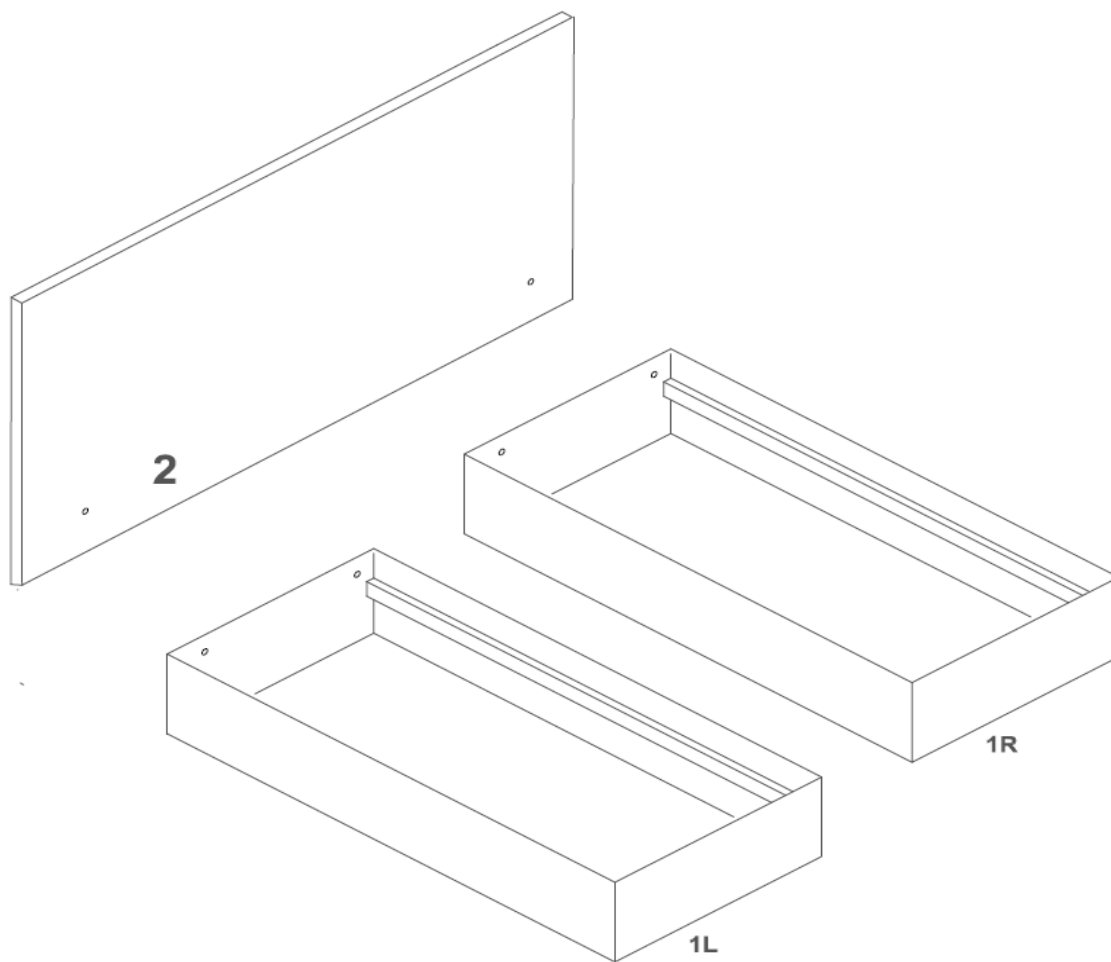

A	B	C	D	E	F	G	H
1x 6x45	1x M6	1x M6	1x M6	4x	2x 8x50	2x M8	2x M8



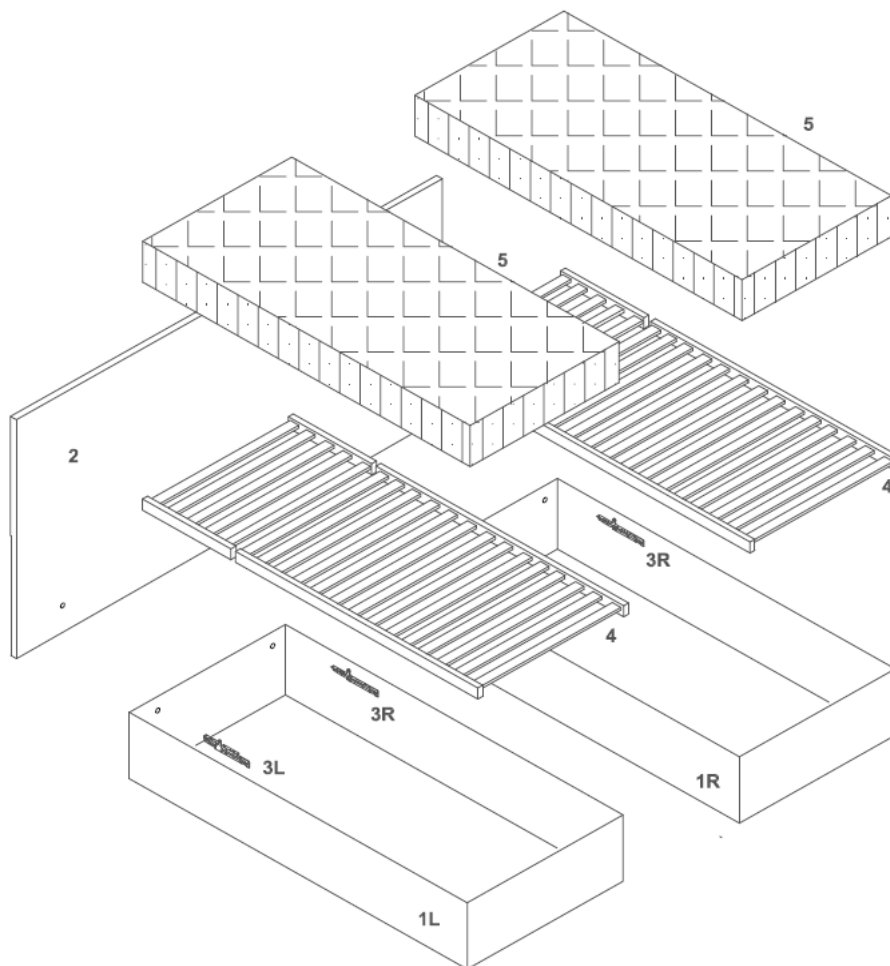

0  
10  
20  
30  
40  
50  
60  
70  
80  
90  
100  
110  
120  
130  
140  
150  
160  
170  
180  
190  
200

<b>Service • Assistenza • Dienstverlening • Serwis</b> <b>Servis • Szerviz • Сервисная служба</b>	
Name • Nom • Nome • Naam Nazwa • Jméno • Názov • Név Denumire • İsim • Название	<b>Lago 2 A DB</b>
Nr. • No. • N° • Номер • Č • Sz	<b>SH42</b>
Typ • Type • Tip • Típus • Tipo Тип	<b>LARO</b>



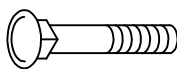

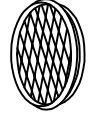

A	B	C	D	E	F	G	H
1x 6x45	1x M6	1x M6	1x M6	4x	2x 8x50	2x M8	2x M8

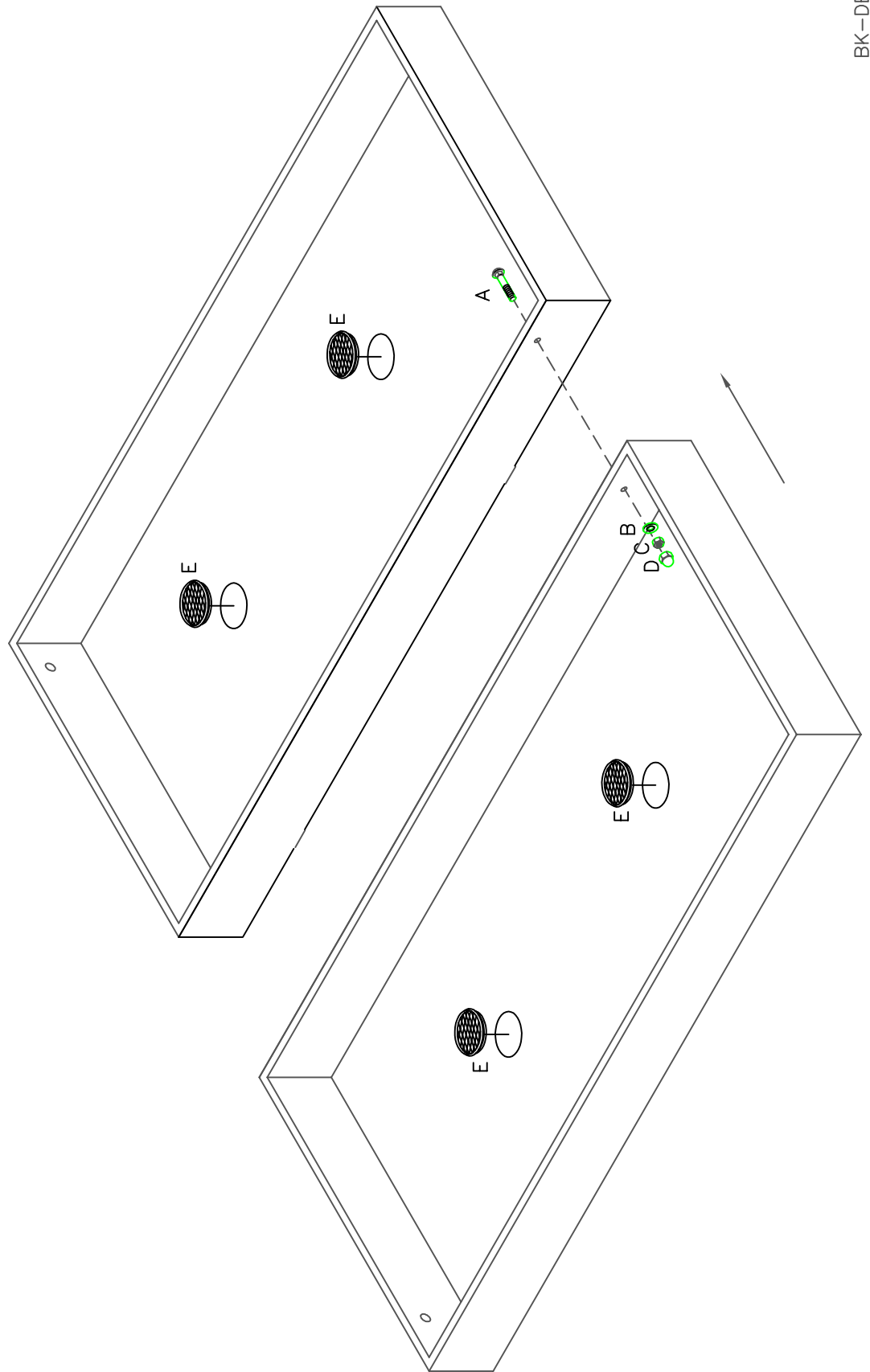

A	B	C	D	E
				
1 x 6x45	1 x M6	1 x M6	1 x M6	4 x



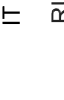

F		H		Achtung! Schrauben nicht überdrehen	FR Attention! Ne serrez pas trop	CZ Dávej Pozor! Nepřetahujte	RO Ai Grija! Nu strângeți	PL Uwaga! Nie dokręcać zbyt mocno	HU Vigyázz! Ne húzza túl	GB Watch Out! Do not over tighten	NL Let Op! Niet te vast	IT Attenzione! Non stringere	RU Осторожно! Не затягивайте	SK Dávaj Pozor! Nepretahujte	TR Dikkat! Üzerinde sıkmayın
2x	8x50	G		FR Attention! Ne serrez pas trop	CZ Dávej Pozor! Nepřetahujte	RO Ai Grija! Nu strângeți	PL Uwaga! Nie dokręcać zbyt mocno	HU Vigyázz! Ne húzza túl	GB Watch Out! Do not over tighten	NL Let Op! Niet te vast	IT Attenzione! Non stringere	RU Осторожно! Не затягивайте	SK Dávaj Pozor! Nepretahujte	TR Dikkat! Üzerinde sıkmayın	
2x	M8	H		GB Watch Out! Do not over tighten	NL Let Op! Niet te vast	IT Attenzione! Non stringere	RU Осторожно! Не затягивайте	SK Dávaj Pozor! Nepretahujte	TR Dikkat! Üzerinde sıkmayın						
2x	M8	G		GB Watch Out! Do not over tighten	NL Let Op! Niet te vast	IT Attenzione! Non stringere	RU Осторожно! Не затягивайте	SK Dávaj Pozor! Nepretahujte	TR Dikkat! Üzerinde sıkmayın						

