

PERCY V
2501-0037/8300
8100/2503-0037

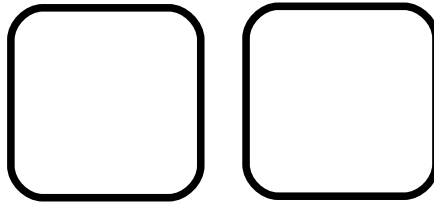

201117

- | | | | |
|-----------|--|-----------|---|
| D | MONTAGEANLEITUNG BEDIENUNGSANLEITUNG | GB | ASSEMBLY INSTRUCTIONS INSTRUCTION MANUAL |
| NL | HANDLEIDING VOOR DE MONTAGE GEBRUIKSAANWIJZING | PL | INSTRUKCJA MONTAŻU INSTRUKCJA OBSŁUGI |
| TR | MONTAJ TALIMATI KULLANIM KLAVUZU | RU | ИНСТРУКЦИЯ ПО МОНТАЖУ ИНСТРУКЦИЯ ПО ЭКСПЛУАТАЦИИ |
| RO | INSTRUCȚIUNI DE INSTALARE INSTRUCȚIUNI DE UTILIZARE | IT | ISTRUZIONI DI MONTAGGIO MANUALE DI ISTRUZIONI |
| FR | NOTICE DE MONTAGE MANUEL INSTRUCTIONS | SK | MONTÁŽNY NÁVOD NÁVOD NA POUŽITIE |
| HU | KÖZGYŰLÉS UTASÍTÁSOK KEZELÉSI UTASÍTÁS | CZ | MONTÁŽNÍ NÁVOD NÁVOD K POUŽITÍ |
| SI | NAVODILA ZA MONTAŽO NAVODILA ZA UPORABO | PT | INSTRUÇÕES DE MONTAGEM MANUAL DO USUÁRIO |
| ES | INSTRUCCIONES DE MONTAJE MANUAL DEL USUARIO | HR | UPUTE ZA MONTAŽU UPUTE ZA UPOTREBU |



0064

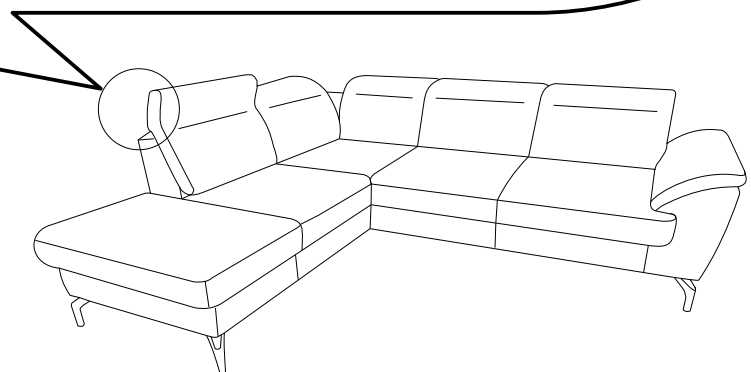
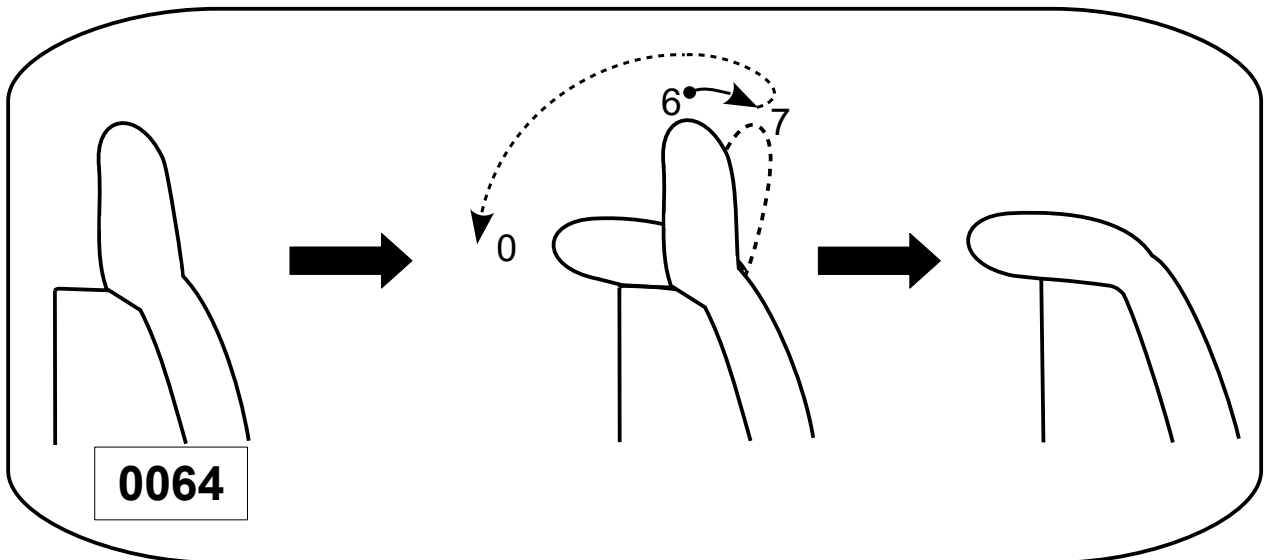
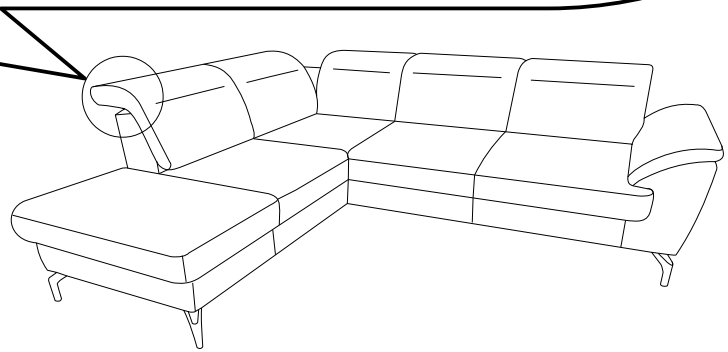
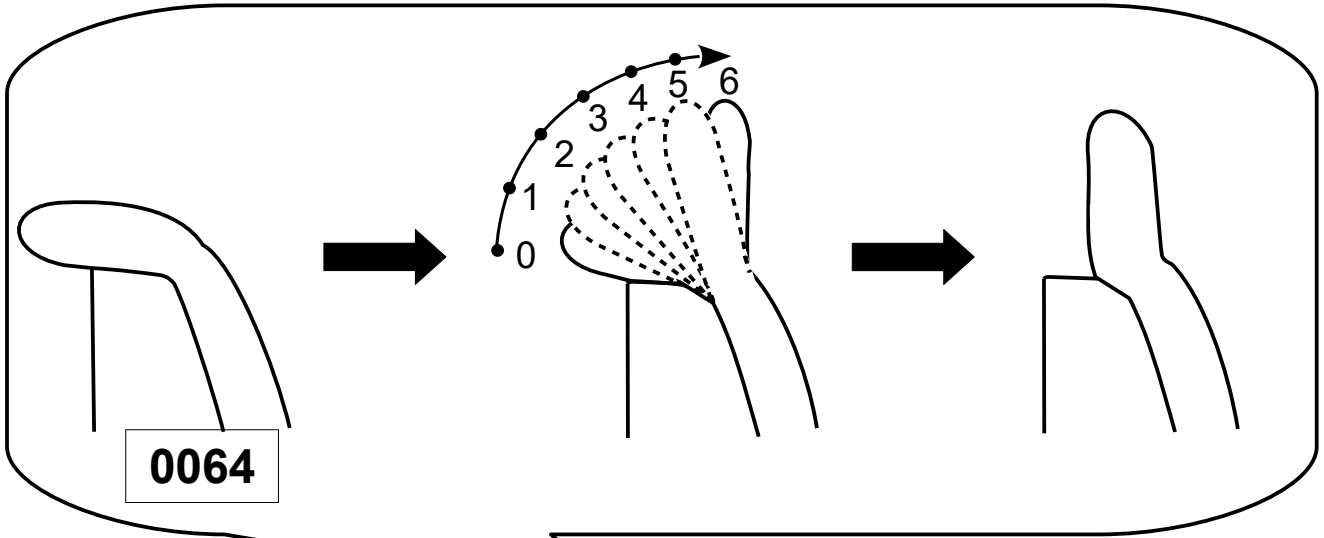

R

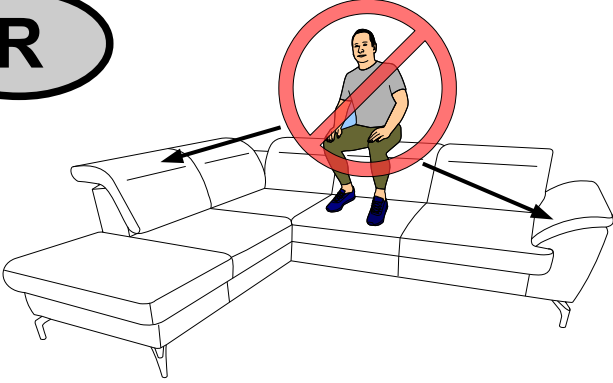

L

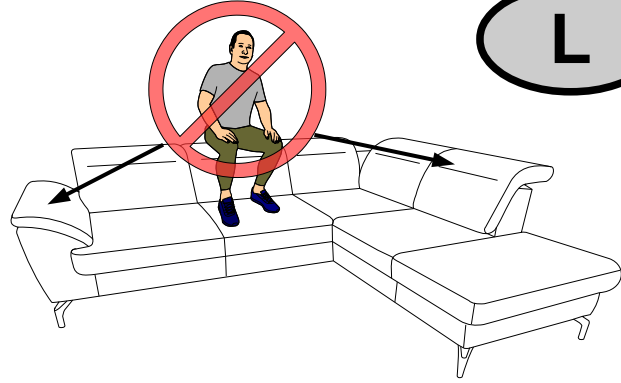



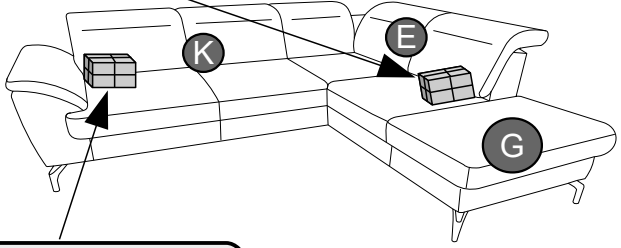
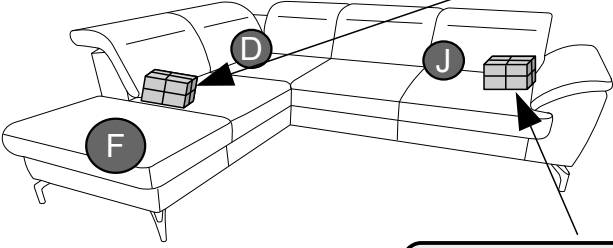

| | | | | | |
|---|--|---|---------------------------|------------------------|------|
| y _{H-120/150} X1 | z _{H(120-180)} X3 | x _{H-120/150} X3 | q M6*25 X12 | i L-4 X1 | [mm] |
|---|--|---|---------------------------|------------------------|------|

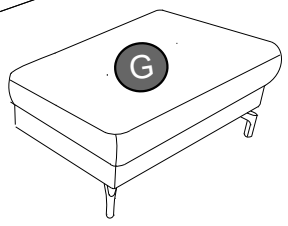
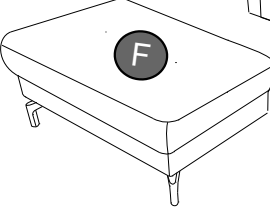
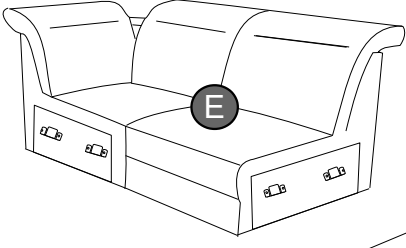
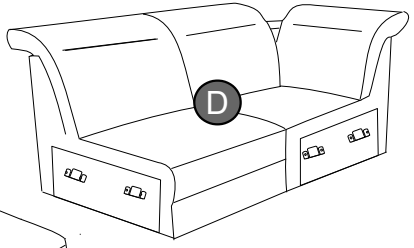
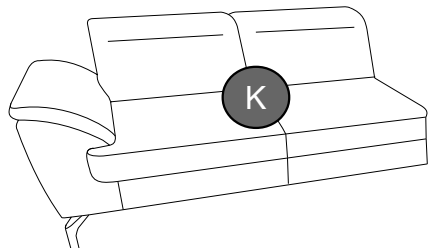
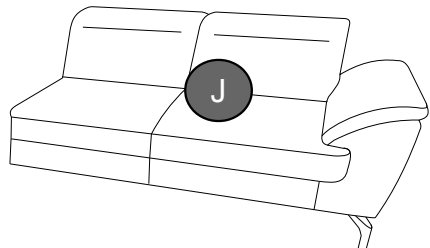

| | | | |
|--|---|--------------------------|------------------------|
| z _{H(120-180)} X2 | x _{H-120/150} X2 | q M6*25 X8 | i L-4 X1 |
|--|---|--------------------------|------------------------|



| | | | | |
|---|--|---|--|--|
| y ^{H-120/150}  | z ^{H(120-180)}  | x ^{H-120/150}  | q M6*25  | i L-4  |
| X1 | X5 | X5 | X20 | X1 |

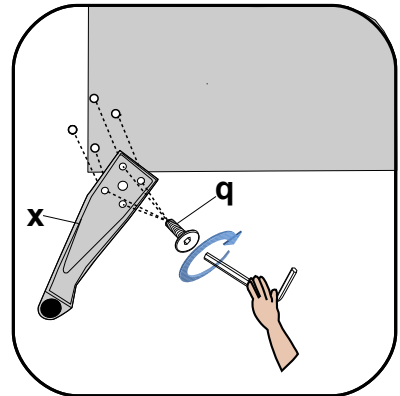
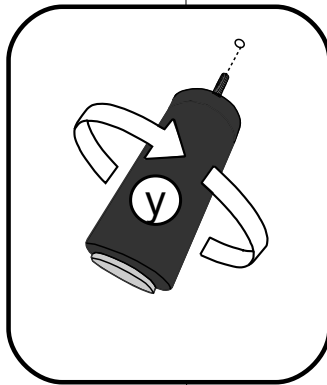
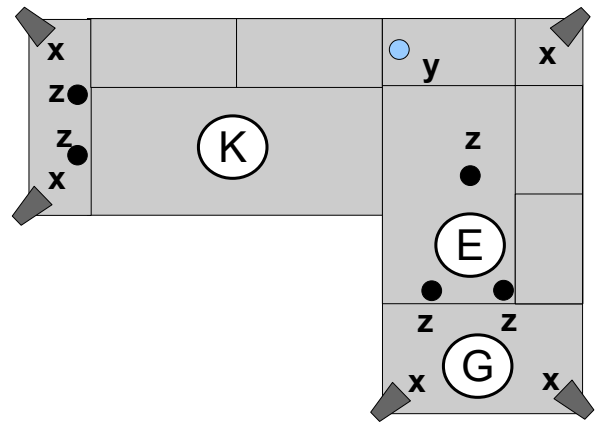
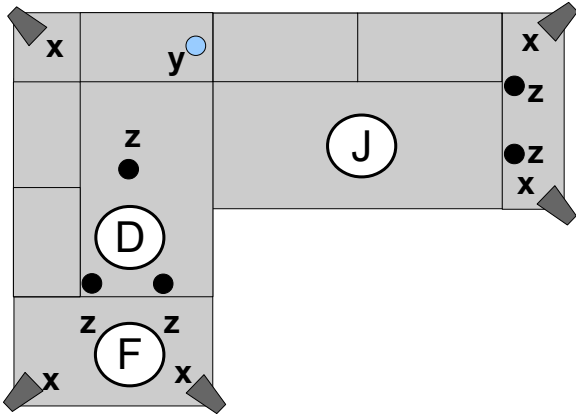
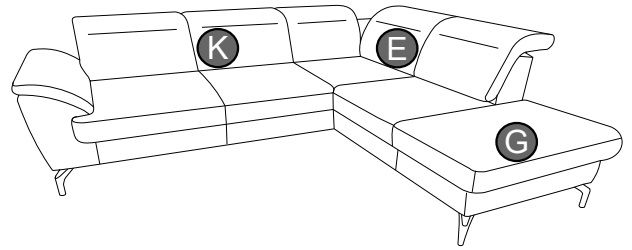
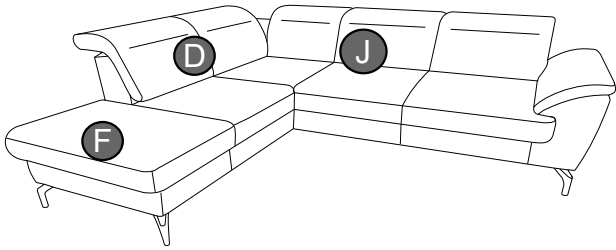

Large assembly diagram for part z. It shows the height adjustment mechanism with a vertical double-headed arrow and a circular arrow indicating rotation. The height is labeled as 120/150. A warning icon (exclamation mark) is present. Two diagrams show the correct placement of the sofa on the legs (marked with a checkmark) and the incorrect placement (marked with a red X). A hand is shown holding a screwdriver to adjust the mechanism.

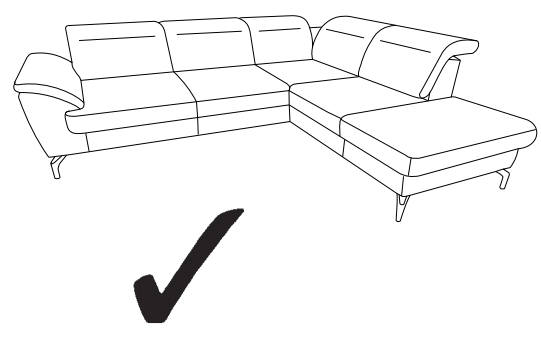
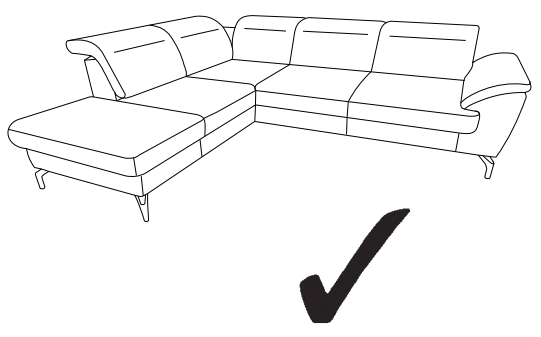
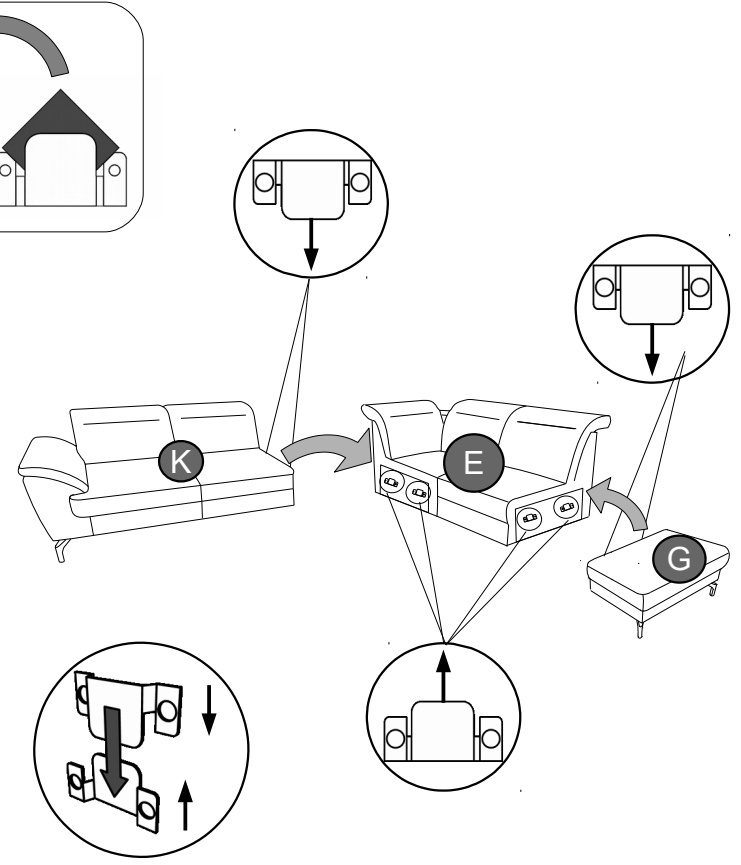
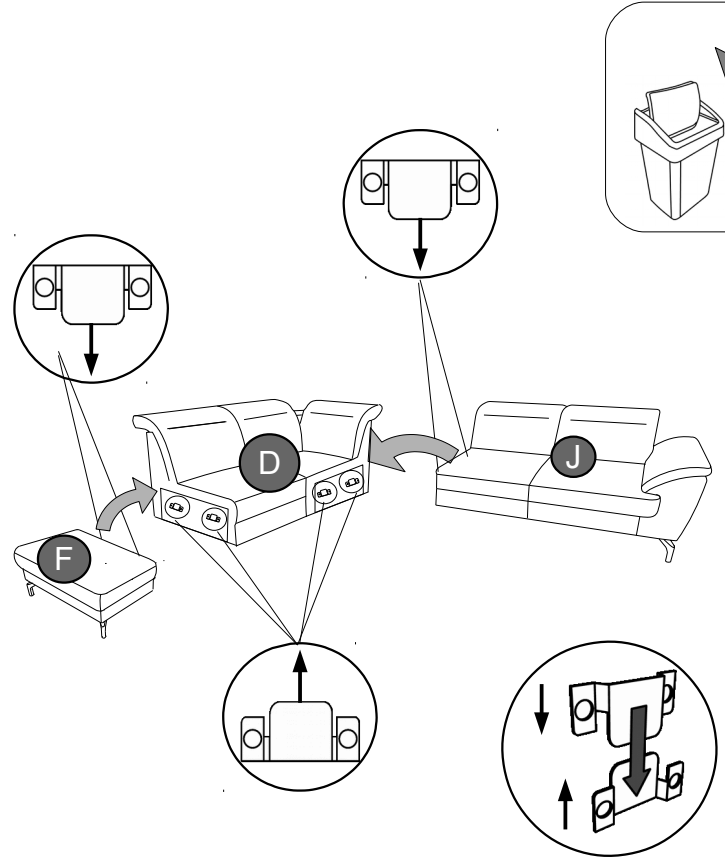

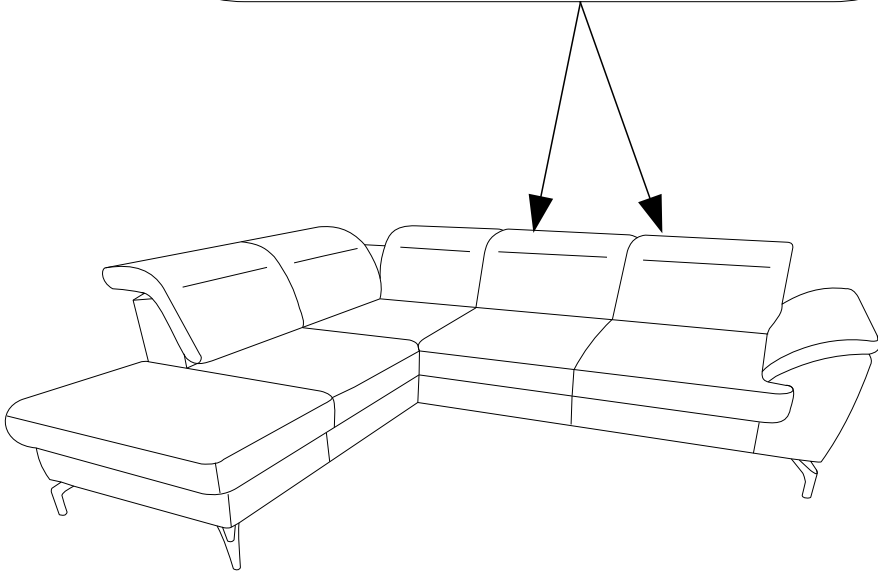
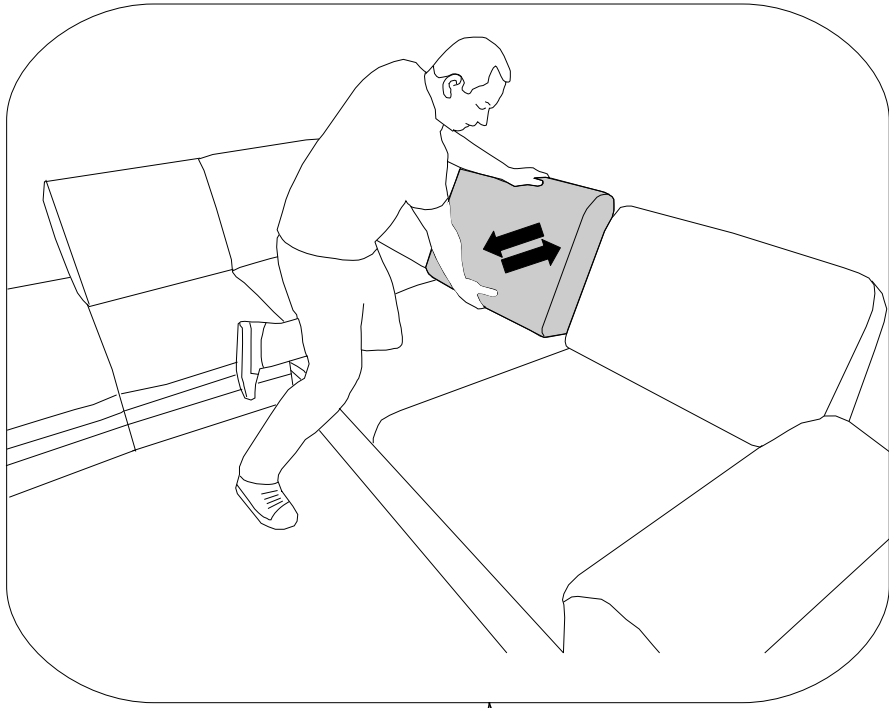

Service · Dienstverlening · Servis · Servis · Servis · Servisna služba · Serviciu · Services · Servizio
 ·Servisný list · Szolgáltatás · Servisní list

Name · Naam · Nazwa · İsim · Название · Nume · Nome · Názov · Názov ·
 Název · Neve

PERCY V

Typ · Type · Tip · Тип · Tipo · Típus

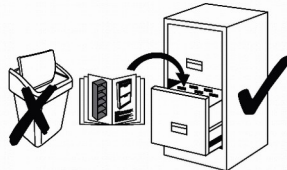
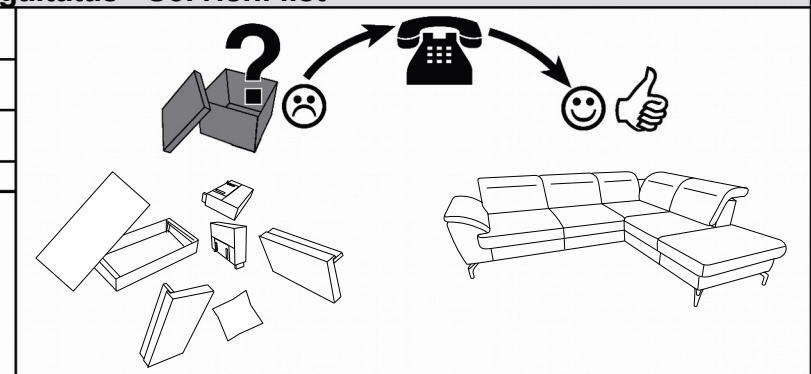



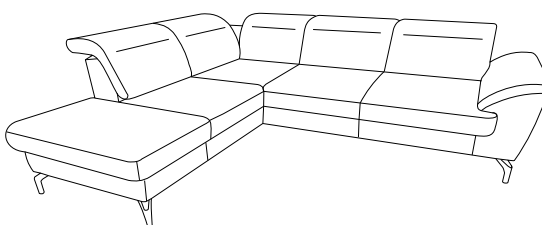

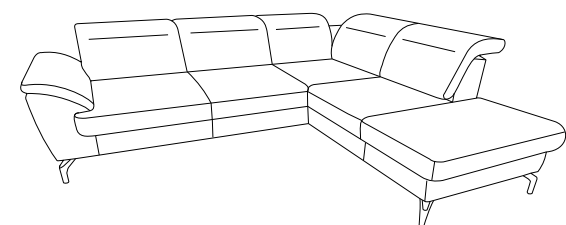

R



L



| | | | | |
|--|---|--|---|--|
| y _{H-120/150}  | Z _{H(120-180)}  | X _{H-120/150}  | q M6*25  | i L-4 [mm]  |
|--|---|--|---|--|

