



(D) Montageanleitung

(GB) Assembly instructions

(FR) Notice de montage

(TR) Montaj talimatı

(IT) Istruzioni di montaggio

(NL) Handleiding voor de montage

(RU) Инструкция по монтажу

(CZ) Montážní návod

(HU) Szerelési útmutató

(RO) Instrucțiuni de montaj

(PL) Instrukcja montażu

(SK) Návod na montáž

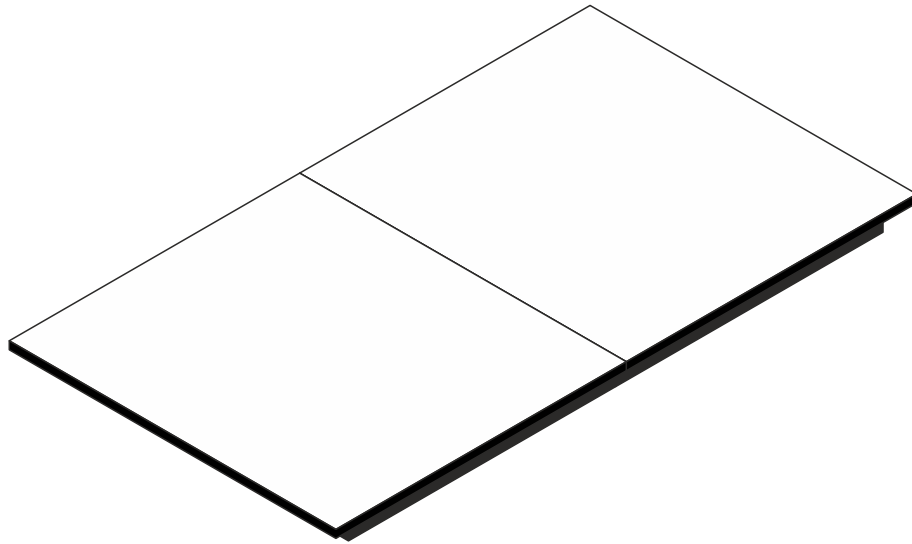





Art.Nr. : 0571_160-240 Esstisch

Service • Assistenza • Dienstverlening • Servis
Servis • Szerviz • Сервисная служба

	Colli 1/2 : (1) (2) (3) (4) Beutel 1/1

Beutel 1/1

1-329		1-351		2-211		2-212		5-130	
24x		24x		9x		9x		3x	

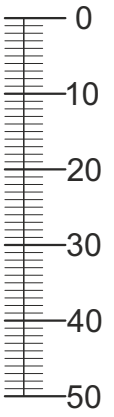

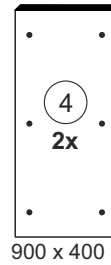
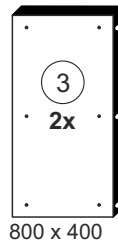
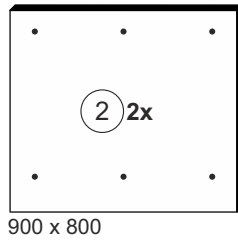
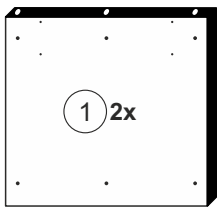

Colli 1/2

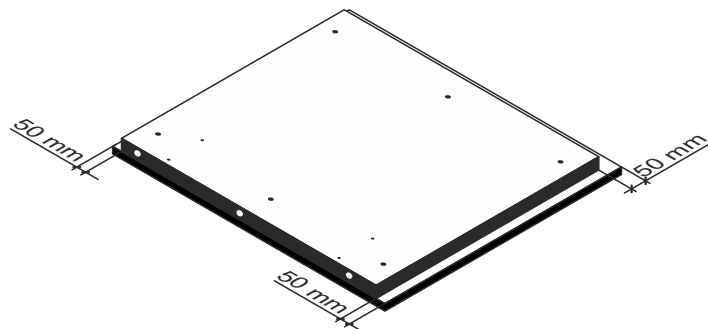
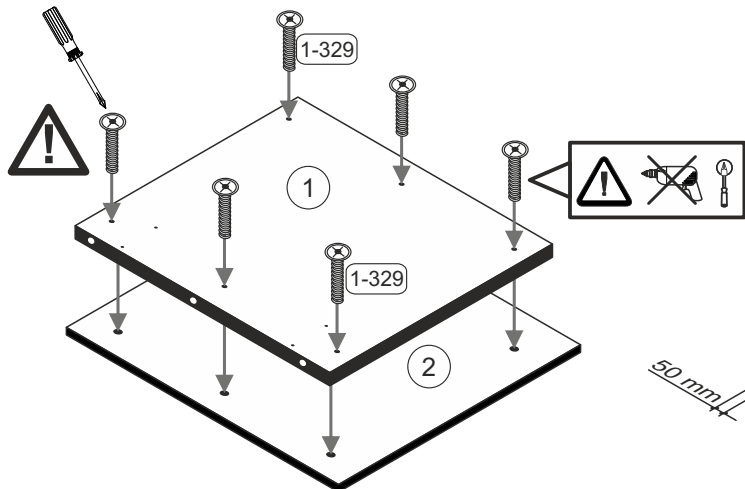
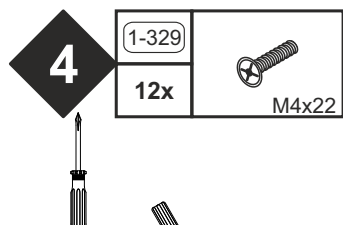
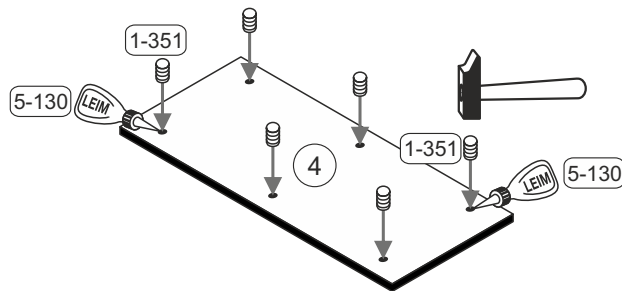
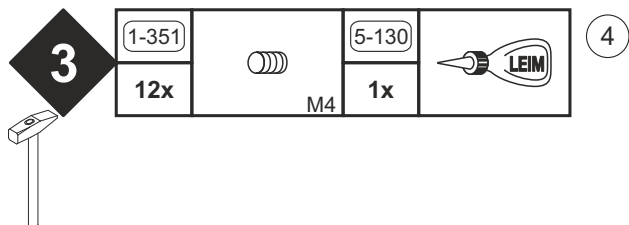
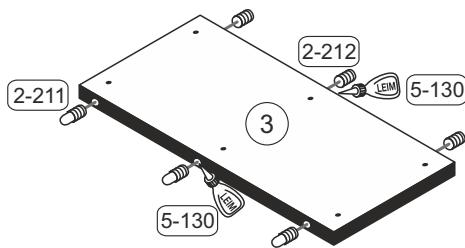
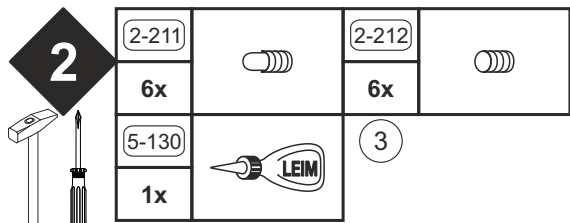
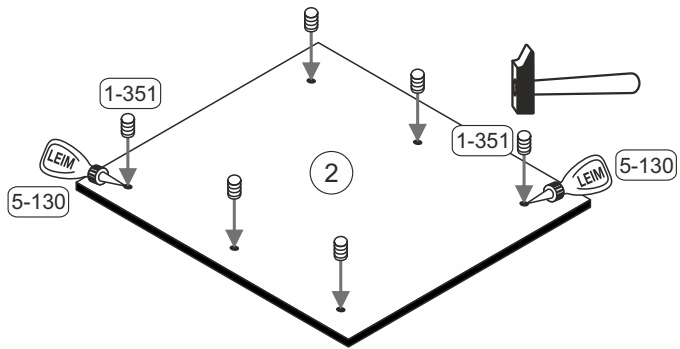
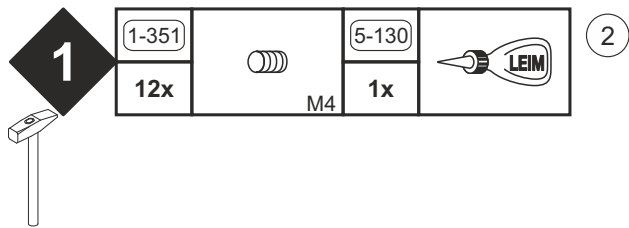

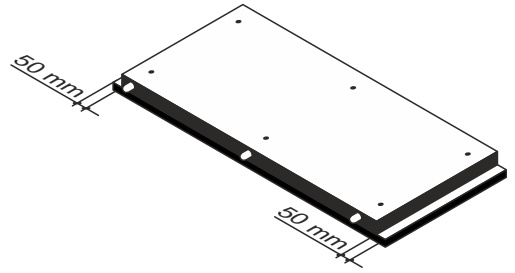
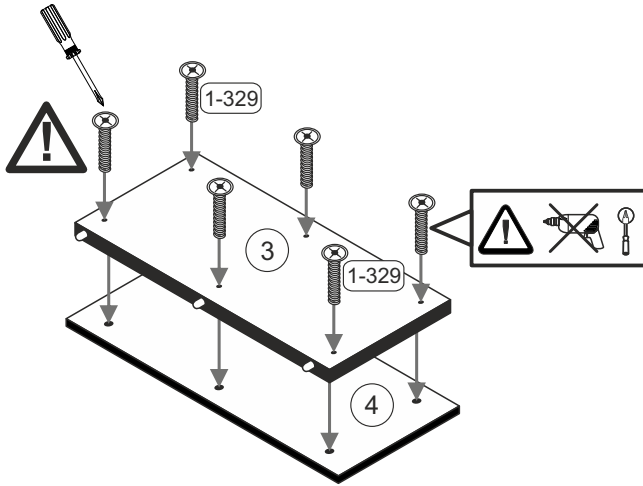

5	1-329	 M4x22
	12x	



6	2-211	2-212	5-130	 LEIM	①
	3x	3x	1x		

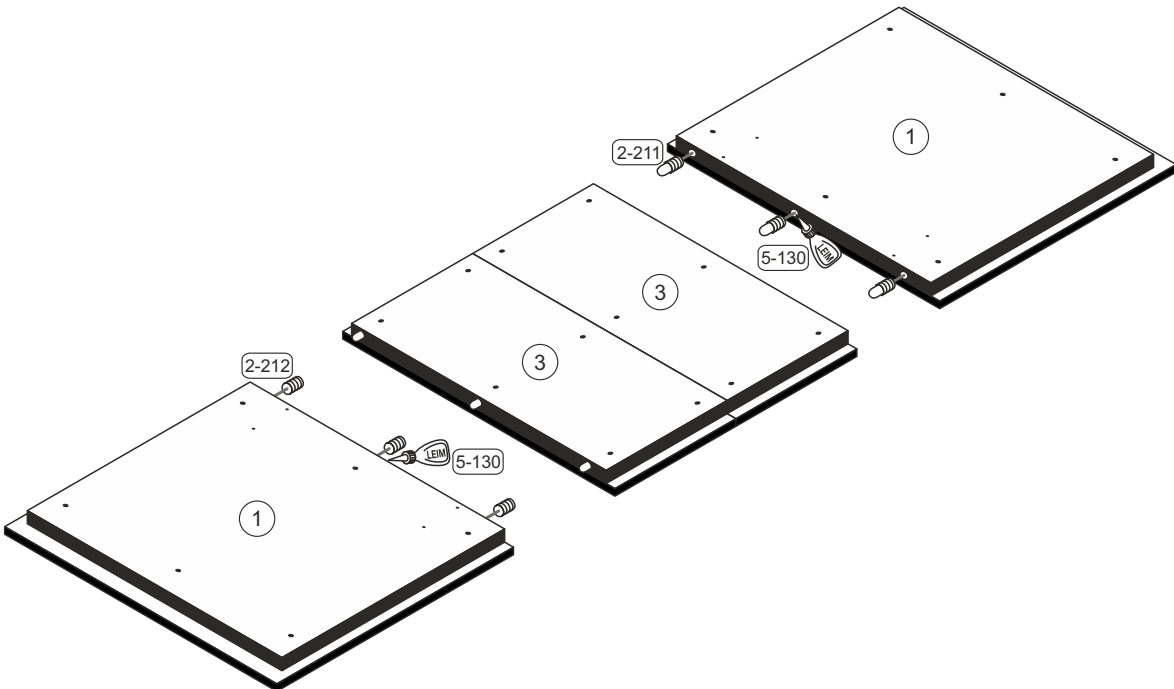
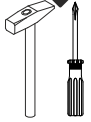



(D) Montageanleitung

(GB) Assembly instructions

(FR) Notice de montage

(TR) Montaj talimatı

(IT) Istruzioni di montaggio

(NL) Handleiding voor de montage

(RU) Инструкция по монтажу

(CZ) Montážní návod

(HU) Szerelési útmutató

(RO) Instrucțiuni de montaj

(PL) Instrukcja montażu

(SK) Návod na montáž

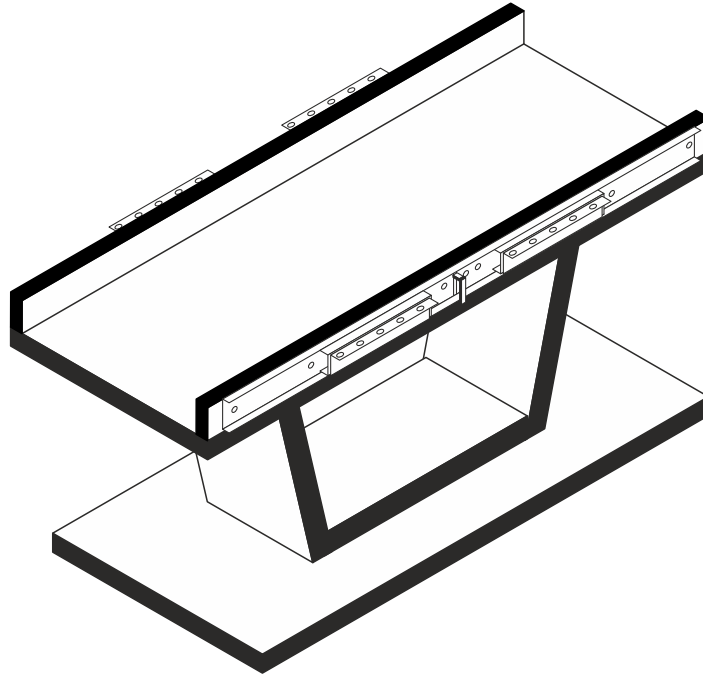



Art.Nr. : 0573_M+F P2

Mittelteil + Fuß



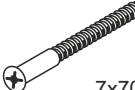
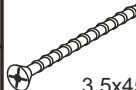

Service • Assistenza • Dienstverlening • Serwis
Servis • Szerviz • Сервисная служба

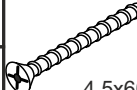
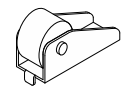
	Colli 2/2: (1) (2) (3) (4) (5) (6) (7) (8) (9) Beutel 1/2, 2/2

Beutel 1/2

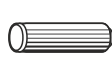
1-05		1-20		1-120		1-122		1-175		2-174	
6x	6,3x35	12x	7x70	10x	3,5x45	40x	10x	10x	4,5x60	4x	

Beutel 2/2

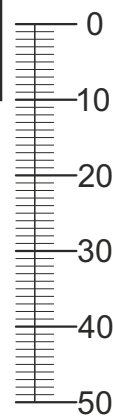

2-103		2-165		5-01		5-130	
8x	8x30	12x		18x		2x	

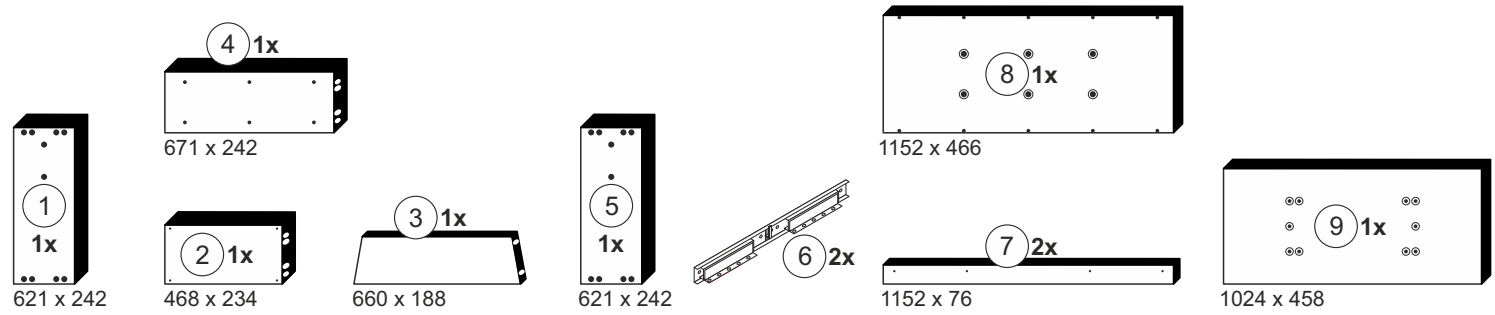

Colli 2/2



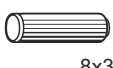

1

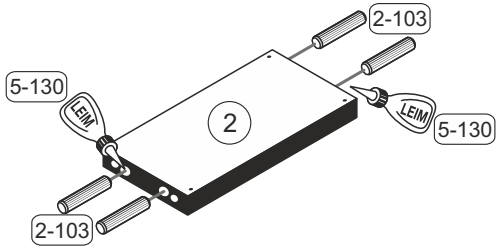
2-103		5-130		2
4x	8x30	1x		



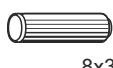

2

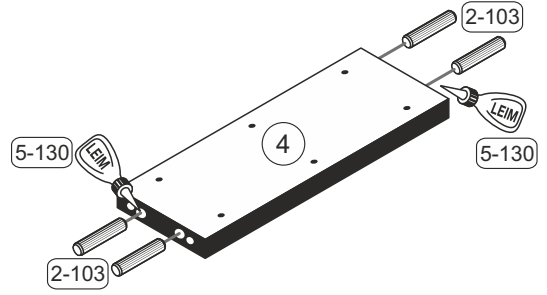
2-103		5-130		4
4x	8x30	1x		



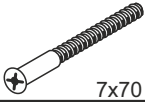

3

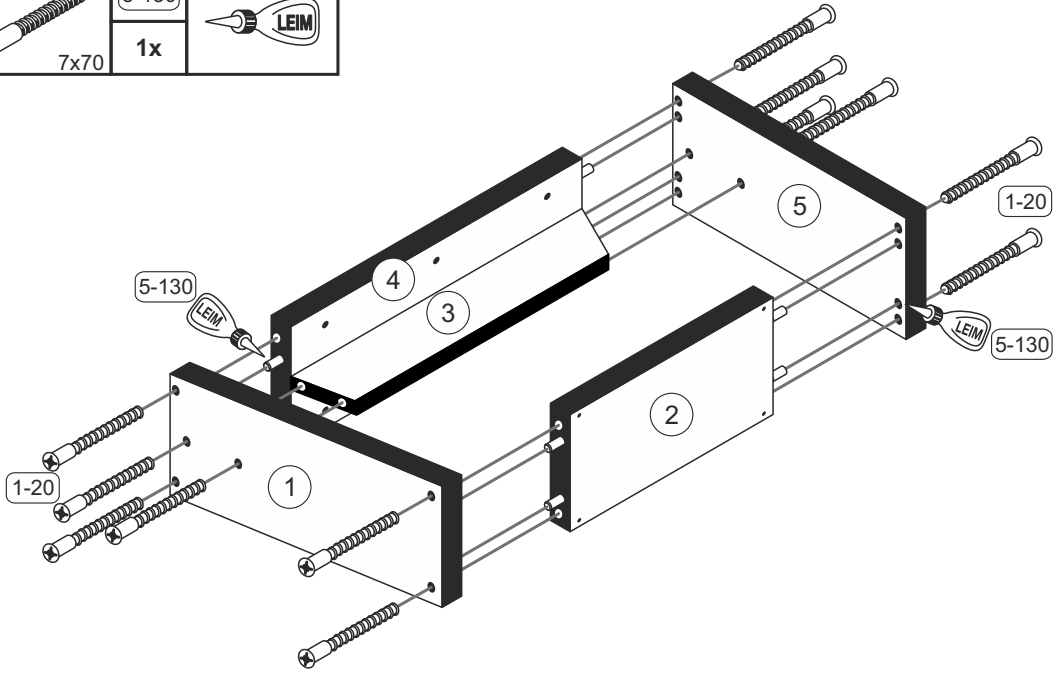

1-20		5-130	
12x	7x70	1x	

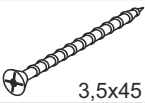

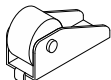

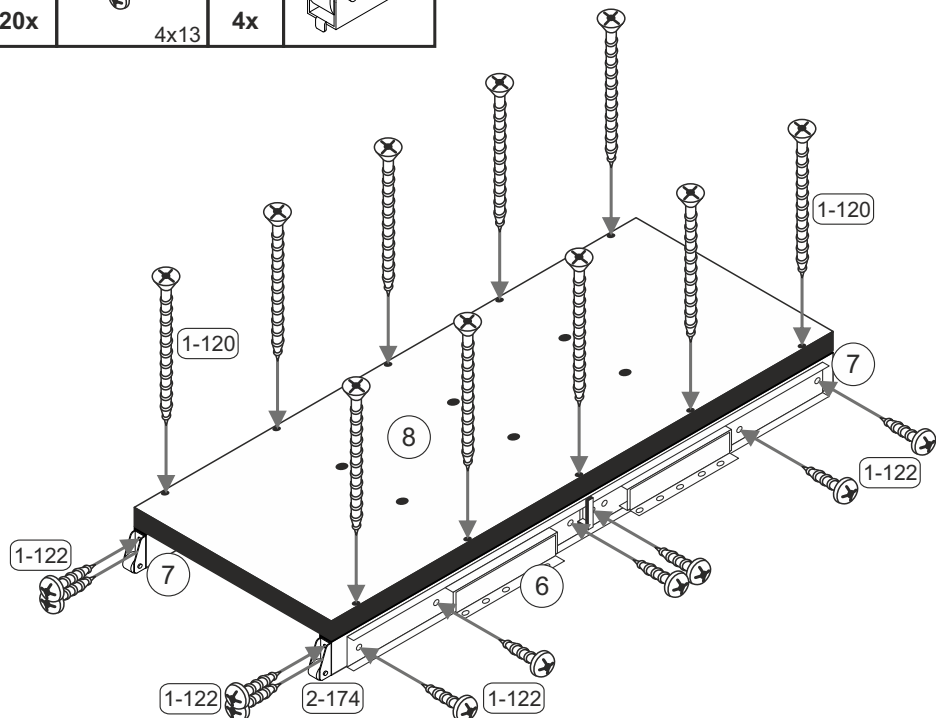
4

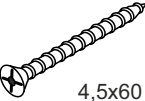
1-120		1-122		2-174	
10x	3,5x45	20x	4x13	4x	

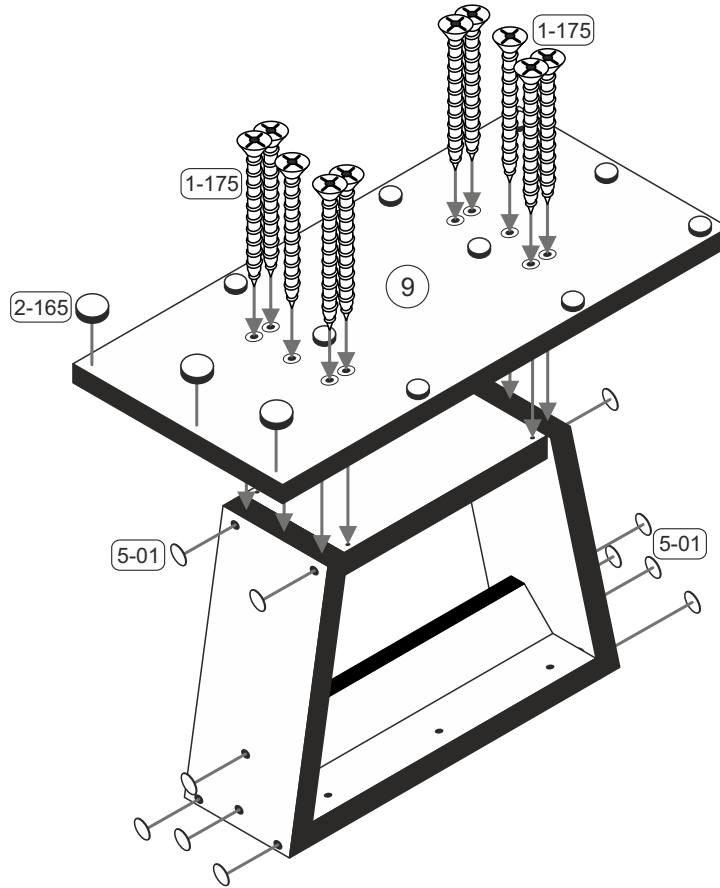

5	1-175	 4,5x60	2-165		5-01	
	10x		12x		12x	



6	1-05	 6,3x35	5-01	
	6x		6x	

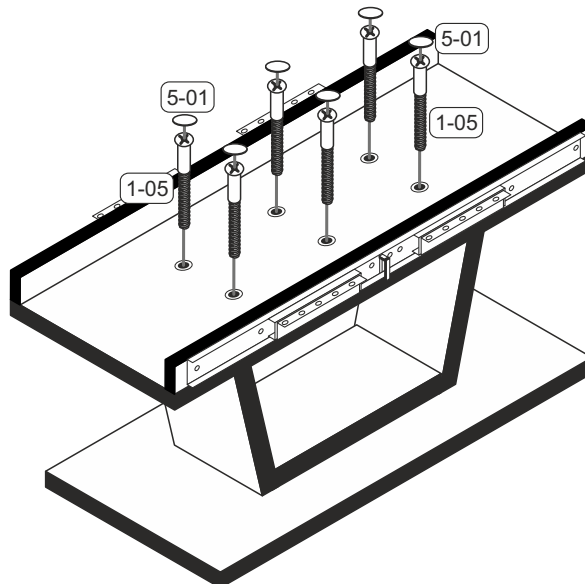

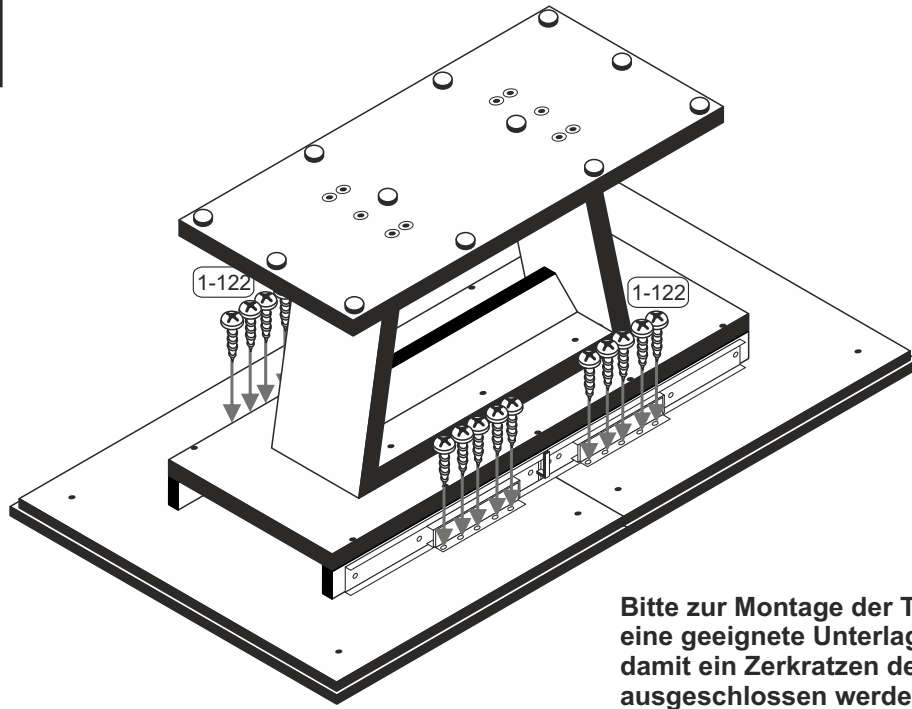
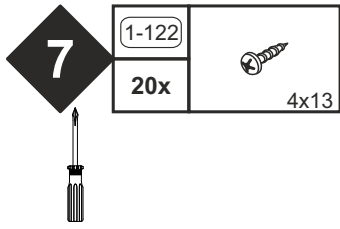

Bitte zur Montage der Tischplatte eine geeignete Unterlage verwenden, damit ein Zerkratzen der Oberplatte ausgeschlossen werden kann!

